

Case File Number: PLN16-412

February 15, 2017

Location: The public Right of Way in front of 2400 66th Avenue on a PG&E Utility /Telephone Pole (See map on reverse)

Assessor Parcel Numbers: (039- 3259-028-00) nearest lot adjacent to the project site.

Proposal: Installation of a wireless telecommunication facility on a 38'-6" tall wooden utility pole located in the public right-of-way. The project involves installation of one (1) canister antenna (23.5" long and 7.9" in diameter) at a height of 18' and two radio units (7.9" tall and 7.9" wide) 10'-6" and 13'-11" above ground.

Applicant: Black & Veatch for Extenet Systems

Contact Person/ Phone Number: Ana Gomez of Black & Veatch (913) 458-9148

Owner: Pacific Gas & Electric (PG&E)

Case File Number: PLN16-412

Planning Permits Required: Major Design Review to install a wireless Macro Telecommunications Facility on an existing PG&E pole located in the public right -of- way in a residential zone.

General Plan: Detached Unit Residential

Zoning: RD-1 Detached Unit Residential.

Environmental Determination: Exempt, Section 15303 of the State CEQA Guidelines, new construction or conversion of small structures; Section 15183, projects consistent with a community plan, general plan or zoning.

Historic Status: No Historic Record – Utility Pole

Service Delivery District: 4

City Council District: 6

Date Filed: December 2, 2016

Finality of Decision: Appealable to City Council within 10 Days

For Further Information: Contact case planner Jason Madani at (510) 238-4790 or jmadani@oaklandnet.com

SUMMARY

The project applicant (Extenet Systems) is proposing to install a wireless telecommunication facility on an existing 38'-6" tall wooden PG&E utility pole located in the public right-of-way near 2400 66th Avenue. The project involves installation of one (1) canister antenna located within antenna shroud and two radio units (7.9" tall and 7.9" wide) mounted at a height of 10'-6" and 13'-11" above ground.

Major Design Review is required for the installation of a new Macro Telecommunications Facility in a residential zone. The proposed antenna and associated equipment are compatible with the existing PG&E utility pole and typical of utility infrastructure normally found on these poles. The proposed antenna will be extended toward the street and painted a gray or brown color to blend with the site. As result, the proposed telecommunication facility is in an appropriate location and would not significantly increase negative visual impacts to adjacent

CITY OF OAKLAND PLANNING COMMISSION

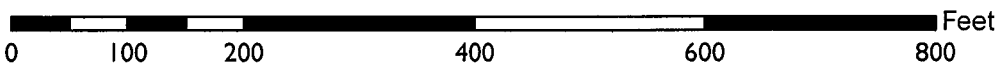

Case File: PLN16412

Applicant: Black & Veatch for Extenet Systems

Address: The public Right of Way in front of
2400 66th Avenue on a JPA Utility Pole

Zone: RD-1

neighboring residential properties. The proposed project meets all the required findings for approval of this project.

TELECOMMUNICATIONS BACKGROUND

Limitations on Local Government Zoning Authority under the Telecommunications Act of 1996

Section 704 of the Telecommunications Act of 1996 (TCA) provides federal standards for the siting of "Personal Wireless Services Facilities." "Personal Wireless Services" include all commercial mobile services (including personal communications services (PCS), cellular radio mobile services, and paging); unlicensed wireless services; and common carrier wireless exchange access services. Under Section 704, local zoning authority over personal wireless services is preserved such that the FCC is prevented from preempting local land use decisions; however, local government zoning decisions are still restricted by several provisions of federal law. Specifically:

- Under Section 253 of the TCA, no state or local regulation or other legal requirement can prohibit or have the effect of prohibiting the ability of any entity to provide any interstate or intrastate telecommunications service.
- Further, Section 704 of the TCA imposes limitations on what local and state governments can do. Section 704 prohibits any state and local government action which unreasonably discriminates among personal wireless providers. Local governments must ensure that its wireless ordinance does not contain requirements in the form of regulatory terms or fees which may have the "effect" of prohibiting the placement, construction, or modification of personal wireless services.
- Section 704 also preempts any local zoning regulation purporting to regulate the placement, construction and modification of personal wireless service facilities on the basis, either directly or indirectly, on the environmental effects of radio frequency emissions (RF) of such facilities, which otherwise comply with Federal Communications Commission (FCC) standards in this regard. (See 47 U.S.C. Section 332(c)(7)(B)(iv) (1996)). This means that local authorities may not regulate the siting or construction of personal wireless facilities based on RF standards that are more stringent than those promulgated by the FCC.
- Section 704 mandates that local governments act upon personal wireless service facility siting applications to place, construct, or modify a facility within a reasonable time (See 47 U.S.C.332(c)(7)(B)(ii) and FCC Shot Clock ruling setting forth "reasonable time" standards for applications deemed complete).
- Section 704 also mandates that the FCC provide technical support to local governments in order to encourage them to make property, rights-of-way, and easements under their jurisdiction available for the placement of new spectrum-based telecommunications services. This proceeding is currently at the comment stage.

For more information on the FCC's jurisdiction in this area, consult the following: Competition & Infrastructure Policy Division (CIPD) of the Wireless Telecommunications Bureau, main division number: (202) 418-1310. <https://www.fcc.gov/general/competition-infrastructure-policy-division-wireless-telecommunications-bureau>

PROPERTY DESCRIPTION

The existing 38'-6" high PG&E utility pole is in the City of Oakland public right -of-way and is 23' away from an adjacent one-story residential building at 2400 66th Avenue.

PROJECT DESCRIPTION

The applicant is proposing to install a telecommunication facility on an existing PG&E utility pole located within in the public right-of-way (Attachment A). The project involves:

- Installation of one canister antenna measuring 23.5" long and 7.9" in diameter at a height of 18'.
- Installation of two radio units (7.9" tall and 7.9" wide) mounted 10'-6" and 13'-11" above ground.
- Installation of a breaker box and smart meter mounted to the pole 8' above ground.
- Painting the proposed antennas and associated equipment grey or brown to match the pole and/or other utilities located on the pole.

No portion of the telecommunication facilities will be located on the ground. The proposed antenna and associated equipment will not be accessible to the public.

GENERAL PLAN ANALYSIS

The site is classified Detached Unit Residential per the Oakland General Plan's Land Use and Transportation Element (LUTE). This classification is intended to create, maintain, and enhance residential areas typically located near the City's major arterials and characterized by detached, single unit structures. "Future development within this classification should be primarily residential in character."

The proposed telecommunication facilities will be mounted on an existing PG&E utility pole within the City of Oakland public right-of-way. The proposed unmanned wireless telecommunication facility will not adversely affect and detract from the characteristics of the neighborhood.

ZONING ANALYSIS

The proposed telecommunication facility is located within the RD-1 Detached Unit Residential Zone. The intent of the RD-1 Zone is to create, maintain, and enhance areas with detached, single unit structures.

Section 17.136.040 and 17.128.070 of the City of Oakland Planning Code requires a Major Design Review permit for Macro Telecommunication facilities that are attached to utility poles in the RD-1 Zone or that are located within one hundred (100) feet of the boundary of any residential zone. Special findings are also required for Design Review approval to ensure that the facility is concealed to the greatest extent possible. The project design is discussed later in the *Key Issues* section of this report, and the required findings for Major Design Review are listed and included in staff's evaluation later in this report.

ENVIRONMENTAL DETERMINATION

The California Environmental Quality Act (CEQA) Guidelines lists the projects that qualify as categorical exemptions from environmental review. The proposed project is categorically exempt from the environmental review requirements pursuant to Section 15303, new construction or conversion of small structures and Section 15183, projects consistent with a community plan, general plan or zoning.

KEY ISSUES AND IMPACTS

Project Site

Section 17.128.110 of the City of Oakland Telecommunication Regulations requires that new wireless facilities shall generally be located on designated properties or facilities in the following ranked order of preference:

- A. Co-located on an existing structure or facility with existing wireless antennas.
- B. City owned properties or other public or quasi-public facilities.
- C. Existing commercial or industrial structures in non-residential zones (excluding all HBX Zones and the D-CE3 and D-C-4 Zones).
- D. Existing commercial or industrial structures in residential zones, HBX Zones, or the D-CE-3 or D-CE-4 Zones.
- E. Other non-residential uses in residential zones, HBX Zones, or the D-CE-3 or D-CE-4 Zones.
- F. Residential uses in non-residential zones (excluding all HBX Zones and the D-CE-3 and D-CE-4 Zones).
- G. Residential uses in residential zones, HBX Zones, or the D-CE-3 or D-CE-4 Zones.

Facilities sited on an A, B or C ranked preference do not require a site alternatives analysis. Since the proposed project involves the installation of a new antenna on an existing PG&E utility pole located within RD-1 Zone, the proposed project meets preferences B and a site alternatives analysis is not required. However, the applicant has provided a site alternatives analysis (Attachment B).

Alternative Site Analysis:

The project is in an area with existing residential structures. The project applicant considered alternative sites on other utility poles in this area but none of these sites are as desirable from a service coverage perspective or from an aesthetics perspective to minimize visual impacts. The proposed project is in an underserved area. The proposed location is approximately equidistant from other Distributed Antenna Systems (DAS) nodes proposed in the surrounding area so that service coverage can be evenly distributed.

Staff has reviewed the applicant's alternative sites analysis and determined that the site selected conforms to the telecommunication regulation requirements. In addition, staff agrees that no other sites are more suitable.

Project Design

Section 17.128.120 of the City of Oakland Telecommunications Regulations requires that new wireless facilities shall generally be designed in the following order of preference:

- A. Building or structure mounted antennas completely concealed from view.
- B. Building or structure mounted antennas set back from roof edge, not visible from the public right-of-way.
- C. Building or structure mounted antennas below roof line (facade mount, pole mount) visible from the public right-of-way, painted to match existing structure.
- D. Building or structure mounted antennas above roof line visible from public right-of-way.
- E. Monopoles.
- F. Towers.

Facilities designed to meet an A and B ranked preference do not require a site design alternatives analysis. Facilities designed to meet a C through F ranked preference, inclusive, must submit a site design alternatives analysis as part of the required application materials. The site design alternatives analysis shall, at a minimum, consist of:

Written evidence indicating why each higher preference design alternative cannot be used. Such evidence shall be in sufficient detail that independent verification could be obtained if required by the City of Oakland Zoning Manager. Evidence should indicate if the reason an alternative was rejected was technical (e.g. incorrect height, interference from existing RF sources, inability to cover required area) or for other concerns (e.g. inability to provide utilities, construction or structural impediments).

Since the proposed project does not meet preference A and B, a site design alternatives analysis is required.

Alternative Design Analysis:

The project applicant submitted an alternative design analysis (Attachment B). The analysis evaluated whether the equipment could be undergrounded and concealed from view. Unfortunately, this is not possible because there is insufficient right-of-way space for the necessary equipment access and the equipment would be compromised by rainwater saturation.

The proposed antenna design is approximately equidistant from other DAS (Distributed Antenna Systems) nodes proposed in the surrounding area so that service coverage can be evenly distributed. The proposed design is a good option because the facility is located where a signal can be adequately propagated without obstruction, which could not have been the case if the antenna was located on a building and concealed.

Planning staff has reviewed the applicant's alternative design analysis and determined that the site selected conforms to the telecommunication regulation requirements. Specifically, given the flat topography, streamlined equipment design, and location of the existing utility pole approximately 23' away from a one-story single-family dwelling, the facility will blend in with the existing PG&E utility pole apparatus. Furthermore, the proposed new antenna is located within a shroud screening mounted onto the PG&E utility pole 18' above ground and the two radio units will be attached to the pole at 10'-6" and 13'-11" in height above the ground. Finally, the shroud and radio units will be painted gray to match the other utilities or brown to match the pole.

Project Radio Frequency Emissions Standards

Section 17.128.130 of the City of Oakland Telecommunication Regulations requires that the applicant submit the following verifications including requests for modifications to existing facilities:

- a. The telecommunications regulations require that the applicant submit written documentation demonstrating that the emission from the proposed project are within the limits set by the Federal Communications Commission.
- b. Prior to final building permit sign off, an RF emissions report indicating that the site is actually operating within the acceptable thresholds as established by the Federal government or any such agency who may be subsequently authorized to establish such standards.

In the RF emissions report (Attachment C) prepared by Hammett & Edison, the proposed project was evaluated for compliance with appropriate guidelines limiting human exposure to radio frequency electromagnetic fields. According to the report on the proposal, the project will comply with the prevailing standards for limiting public exposure to radio frequency energy, and therefore, the proposed site will operate within the current acceptable thresholds as established by the Federal government or any such agency that may be subsequently authorized to establish such standards. The RF emissions report also states that the proposed project will not cause a significant impact on the environment. Additionally, staff recommends that prior to the final building permit sign off, the applicant submit a certified RF emissions report stating that the facility is operating within acceptable thresholds established by the regulatory federal agency.

CONCLUSION

The proposed project meets all the required findings for approval. The proposal will provide an essential telecommunication services to the community and the City of Oakland at large. It will also be available to emergency services such as police, fire department and emergency response teams. Staff believes that the proposal is designed to meet the established zoning and telecommunication regulations and recommends supporting the Major Design Review application.

RECOMMENDATIONS:

1. Affirm staff's environmental determination, and
2. Approve the Design Review application, subject to the attached findings and conditions of approval.

Prepared by:



Jason Madani
Planner II

Reviewed by:

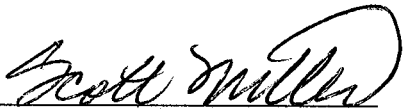

Scott Miller
Zoning Manager

Approved for forwarding to the
City Planning Commission



Darin Ranelletti, Interim Director
Department of Planning and Building

ATTACHMENTS:

- A. Project Plans & Photo simulations
- B. Site & Design Alternative Analysis
- C. Hammett & Edison, Inc., Consulting Engineering RF Emissions Report

FINDINGS FOR APPROVAL**FINDINGS FOR APPROVAL:**

This proposal meets all the required findings under Section 17.136.050(B), of the Non-Residential Design Review criteria and all the required findings under Section 17.128.070(B), of the telecommunication facilities (Macro) Design Review criteria and as set forth below:

Required findings are shown in **bold** type; reasons your proposal satisfies them are shown in normal type.

17.136.050(B) – NONRESIDENTIAL DESIGN REVIEW CRITERIA:

1. That the proposal will help achieve or maintain a group of facilities which are well related to one another and which, when taken together, will result in a well-composed design, with consideration given to site, landscape, bulk, height, arrangement, texture, materials, colors, and appurtenances; the relation of these factors to other facilities in the vicinity; and the relation of the proposal to the total setting as seen from key points in the surrounding area. Only elements of design which have some significant relationship to outside appearance shall be considered, except as otherwise provided in Section 17.136.060;

The proposal is to install one telecommunication canister antenna on an existing, wooden, PG&E utility pole 18' above ground with the associated equipment mounted to the pole at 10'-6" and 13'-11" high and above (breaker box and smart meter). Given the flat topography, slim equipment design, and proposal to paint the equipment, the facility will blend in with and be typical of utility apparatus already located on the pole. In addition, the facility is located approximately 23' away from a one-story single family dwelling. Finally, the proposed antennas and radio units will be located high up on the pole and oriented toward the street. Therefore, the proposal will have minimal visual impacts from public views.

2. That the proposed design will be of a quality and character which harmonizes with, and serves to protect the value of, private and public investments in the area;

The proposal improves wireless telecommunication service in the residential area. The facility will be camouflaged by the slim antenna canister and painted gray or brown color to blend in with the existing surrounding area and have minimal visual impacts on public views and protect the value of private and public investments in the area. Service will also be available to emergency services such as police, fire department and emergency response teams.

3. That the proposed design conforms in all significant respects with the Oakland General Plan and with any applicable design review guidelines or criteria, district plan, or development control map which have been adopted by the Planning Commission or City Council.

The site is classified as Detached Unit Residential per the Oakland General Plan's Land Use and Transportation Element (LUTE). This classification is intended to create, maintain, and enhance residential areas typically located near the City's major arterials and characterized by detached, single unit structures. "Future development within this classification should be primarily residential in character."

Section 17.128.120 of the City of Oakland Telecommunications Regulations describes the design criteria for wireless facilities. In general, these facilities should either be concealed from view or not visible from the public right of way. Since the project did not meet either ranked criteria, but did meet criteria C as described above, an alternative site design study needed to be undertaken. The analysis shows that the proposed pole will be similar to other utility poles within same block and throughout the City. The proposed antenna and associated related equipment are compatible with and typical of the utility equipment on these poles. The proposed antenna will be extended toward street and away from the home at 2400 66th Avenue and painted to match either the pole or utilities. As result, the proposal is consistent telecommunication regulation requirements, is in an appropriate location, and of an appropriate design that would not significantly increase negative visual impacts to adjacent neighboring residential properties

17.128.070(B) DESIGN REVIEW CRITERIA FOR MACRO FACILITIES

1. Antennas should be painted and/or textured to match the existing structure:

The proposed antenna and related equipment will be painted gray or brown to match the PG&E utility pole and blend with the surroundings.

2. Antennas mounted on architecturally significant structures or significant architectural details of the building should be covered by appropriate casings which are manufactured to match existing architectural features found on the building:

The proposed antennas will not be mounted on a building or architecturally significant structure, but rather on a PG&E utility pole.

3. Where feasible, antennas can be placed directly above, below or incorporated with vertical design elements of a building to help in camouflaging:

The proposed antenna will be mounted on an existing PG&E utility pole and painted gray or brown to match the utility pole. As a result, the facility will be camouflaged to blend-in with existing surrounding area. The facility will also be located approximately 10'-6" and 13'-11" above ground and head height to minimize visual impacts.

4. Equipment shelters or cabinets shall be screened from the public view by using landscaping, or materials and colors consistent with surrounding backdrop:

The associated equipment will be attached to an existing utility pole, oriented toward the street and painted to match pole in order to blend with the surroundings. The antenna will be located within an antenna shroud.

5. Equipment shelters or cabinets shall be consistent with the general character of the area.

The proposed equipment will be compatible with the existing PG&E pole and other utility equipment located on the pole.

6. For antennas attached to the roof, maintain a 1:1 ratio for equipment setback; screen the antennas to match existing air conditioning units, stairs, or elevator towers; avoid placing roof mounted antennas in direct line with significant view corridors.

N/A

7. That all reasonable means of reducing public access to the antennas and equipment has been made, including, but not limited to, placement in or on buildings or structures, fencing, anti-climbing measures and anti-tampering devices.

The one telecommunication canister antenna will be placed within an antenna shroud mounted on an existing, wooden, PG&E utility pole 18' above ground. The radio units will be located approximately 10'-6" and 13'-11" above ground, while the equipment above the breaker box and smart meter will be located 8' above the ground. None of the equipment will be accessible to the public due to its location.

STANDARD CONDITIONS:

1. Approved Use

The project shall be constructed and operated in accordance with the authorized use as described in the approved application materials, and the approved plans dated **September 27, 2016** and submitted on **December 2, 2016** as amended by the following conditions of approval and mitigation measures, if applicable (“Conditions of Approval” or “Conditions”).

2. Effective Date, Expiration, Extensions and Extinguishment

This Approval shall become effective immediately, unless the Approval is appealable, in which case the Approval shall become effective in ten calendar days unless an appeal is filed. Unless a different termination date is prescribed, this Approval shall expire **two years** from the Approval date, or from the date of the final decision in the event of an appeal, unless within such period all necessary permits for construction or alteration have been issued, or the authorized activities have commenced in the case of a permit not involving construction or alteration. Upon written request and payment of appropriate fees submitted no later than the expiration date of this Approval, the Director of City Planning or designee may grant a one-year extension of this date, with additional extensions subject to approval by the approving body. Expiration of any necessary building permit or other construction-related permit for this project may invalidate this Approval if said Approval has also expired. If litigation is filed challenging this Approval, or its implementation, then the time period stated above for obtaining necessary permits for construction or alteration and/or commencement of authorized activities is automatically extended for the duration of the litigation.

3. Compliance with Other Requirements

The project applicant shall comply with all other applicable federal, state, regional, and local laws/codes, requirements, regulations, and guidelines, including but not limited to those imposed by the City’s Bureau of Building, Fire Marshal, and Public Works Department. Compliance with other applicable requirements may require changes to the approved use and/or plans. These changes shall be processed in accordance with the procedures contained in Condition #4.

4. Minor and Major Changes

- a. Minor changes to the approved project, plans, Conditions, facilities, or use may be approved administratively by the Director of City Planning
- b. Major changes to the approved project, plans, Conditions, facilities, or use shall be reviewed by the Director of City Planning to determine whether such changes require submittal and approval of a revision to the Approval by the original approving body or a new independent permit/approval. Major revisions shall be reviewed in accordance with the procedures required for the original permit/approval. A new independent permit/approval shall be reviewed in accordance with the procedures required for the new permit/approval.

5. Compliance with Conditions of Approval

- a. The project applicant and property owner, including successors, (collectively referred to hereafter as the “project applicant” or “applicant”) shall be responsible for compliance with all the Conditions of Approval and any recommendations contained in any submitted and

approved technical report at his/her sole cost and expense, subject to review and approval by the City of Oakland.

- b. The City of Oakland reserves the right at any time during construction to require certification by a licensed professional at the project applicant's expense that the as-built project conforms to all applicable requirements, including but not limited to, approved maximum heights and minimum setbacks. Failure to construct the project in accordance with the Approval may result in remedial reconstruction, permit revocation, permit modification, stop work, permit suspension, or other corrective action.
- c. Violation of any term, Condition, or project description relating to the Approval is unlawful, prohibited, and a violation of the Oakland Municipal Code. The City of Oakland reserves the right to initiate civil and/or criminal enforcement and/or abatement proceedings, or after notice and public hearing, to revoke the Approval or alter these Conditions if it is found that there is violation of any of the Conditions or the provisions of the Planning Code or Municipal Code, or the project operates as or causes a public nuisance. This provision is not intended to, nor does it, limit in any manner whatsoever the ability of the City to take appropriate enforcement actions. The project applicant shall be responsible for paying fees in accordance with the City's Master Fee Schedule for inspections conducted by the City or a City-designated third-party to investigate alleged violations of the Approval or Conditions.

6. Signed Copy of the Approval/Conditions

A copy of the Approval letter and Conditions shall be signed by the project applicant, attached to each set of permit plans submitted to the appropriate City agency for the project, and made available for review at the project job site at all times.

7. Blight/Nuisances

The project site shall be kept in a blight/nuisance-free condition. Any existing blight or nuisance shall be abated within 60 days of approval, unless an earlier date is specified elsewhere.

8. Indemnification

- a. To the maximum extent permitted by law, the project applicant shall defend (with counsel acceptable to the City), indemnify, and hold harmless the City of Oakland, the Oakland City Council, the Oakland Redevelopment Successor Agency, the Oakland City Planning Commission, and their respective agents, officers, employees, and volunteers (hereafter collectively called "City") from any liability, damages, claim, judgment, loss (direct or indirect), action, causes of action, or proceeding (including legal costs, attorneys' fees, expert witness or consultant fees, City Attorney or staff time, expenses or costs) (collectively called "Action") against the City to attack, set aside, void or annul this Approval or implementation of this Approval. The City may elect, in its sole discretion, to participate in the defense of said Action and the project applicant shall reimburse the City for its reasonable legal costs and attorneys' fees.
- b. Within ten (10) calendar days of the filing of any Action as specified in subsection (a) above, the project applicant shall execute a Joint Defense Letter of Agreement with the City, acceptable to the Office of the City Attorney, which memorializes the above obligations. These obligations and the Joint Defense Letter of Agreement shall survive termination, extinguishment, or invalidation of the Approval. Failure to timely execute the Letter of

Agreement does not relieve the project applicant of any of the obligations contained in this Condition or other requirements or Conditions of Approval that may be imposed by the City.

9. Severability

The Approval would not have been granted but for the applicability and validity of each and every one of the specified Conditions, and if one or more of such Conditions is found to be invalid by a court of competent jurisdiction this Approval would not have been granted without requiring other valid Conditions consistent with achieving the same purpose and intent of such Approval.

10. Job Site Plans

Ongoing throughout demolition, grading, and/or construction

At least one (1) copy of the stamped approved plans, along with the Approval Letter and Conditions of Approval, shall be available for review at the job site at all times.

11. Special Inspector/Inspections, Independent Technical Review, Project Coordination and Management

Prior to issuance of a demolition, grading, and/or construction permit

The project applicant may be required to pay for on-call special inspector(s)/inspections as needed during the times of extensive or specialized plan check review, or construction. The project applicant may also be required to cover the full costs of independent technical and other types of peer review, monitoring and inspection, including without limitation, third party plan check fees, including inspections of violations of Conditions of Approval. The project applicant shall establish a deposit with the Building Services Division, as directed by the Building Official, Director of City Planning or designee.

12. Days/Hours of Construction Operation

Ongoing throughout demolition, grading, and/or construction

The project applicant shall require construction contractors to limit standard construction activities as follows:

- a) Construction activities are limited to between 7:00 AM and 7:00 PM Monday through Friday, except that pile driving and/or other extreme noise generating activities greater than 90 dBA shall be limited to between 8:00 a.m. and 4:00 p.m. Monday through Friday.
- b) Any construction activity proposed to occur outside of the standard hours of 7:00 am to 7:00 pm Monday through Friday for special activities (such as concrete pouring which may require more continuous amounts of time) shall be evaluated on a case by case basis, with criteria including the proximity of residential uses and a consideration of resident's preferences for whether the activity is acceptable if the overall duration of construction is shortened and such construction activities shall only be allowed with the prior written authorization of the Building Services Division.
- c) Construction activity shall not occur on Saturdays, with the following possible exceptions:
 - i. Prior to the building being enclosed, requests for Saturday construction for special activities (such as concrete pouring which may require more continuous amounts of time), shall be evaluated on a case by case basis, with criteria including the proximity of residential uses and a consideration of resident's preferences for whether the activity is acceptable if the overall duration of construction is shortened. Such

construction activities shall only be allowed on Saturdays with the prior written authorization of the Building Services Division.

- ii. After the building is enclosed, requests for Saturday construction activities shall only be allowed on Saturdays with the prior written authorization of the Building Services Division, and only then within the interior of the building with the doors and windows closed.
- d) No extreme noise generating activities (greater than 90 dBA) shall be allowed on Saturdays, with no exceptions.
- e) No construction activity shall take place on Sundays or Federal holidays.
- f) Construction activities include but are not limited to: truck idling, moving equipment (including trucks, elevators, etc) or materials, deliveries, and construction meetings held on-site in a non-enclosed area.

13. Radio Frequency Emissions

Prior to the final building permit sign off.

The applicant shall submit a certified RF emissions report stating the facility is operating within the acceptable standards established by the regulatory Federal Communications Commission.

14. Operational

Ongoing.

Noise levels from the activity, property, or any mechanical equipment on site shall comply with the performance standards of Section 17.120 of the Oakland Planning Code and Section 8.18 of the Oakland Municipal Code. If noise levels exceed these standards, the activity causing the noise shall be abated until appropriate noise reduction measures have been installed and compliance verified by the Planning and Zoning Division and Building Services.

15. Possible District Undergrounding PG&E Pole

Ongoing

Should the PG &E utility pole be voluntarily removed for purposes of district undergrounding or otherwise, the telecommunications facility can only be re-established by applying for and receiving approval of a new application to the Oakland Planning Department as required by the regulations.

Applicant Statement

I have read and accept responsibility for the Conditions of Approval. I agree to abide by and conform to the Conditions of Approval, as well as to all provisions of the Oakland Planning Code and Oakland Municipal Code pertaining to the project.

Name of Project Applicant

Signature of Project Applicant

Date

Attachment A

NW-CA-SANFRNMC 06276A

ADJACENT TO (IN PROW)
2400 66TH AVENUE
OAKLAND, CA 94605

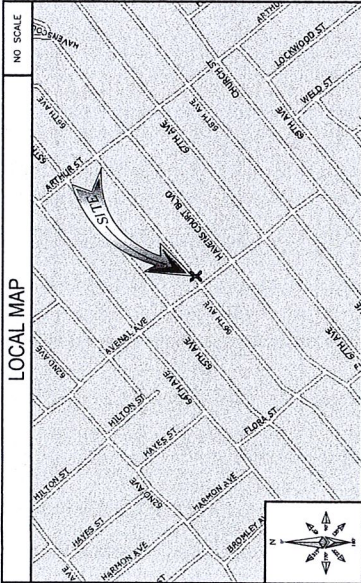

SHEET INDEX	
SHEET NO:	SHEET TITLE
T-1	TITLE SHEET
GN-1	GENERAL NOTES AND LEGEND
C-1	OVERALL SITE PLAN
C-2	UTILITY POLE ELEVATIONS AND RISER DETAILS
C-3	EQUIPMENT DETAILS
C-4	EQUIPMENT DETAILS

IF USING 11"X17" PLOT, DRAWINGS WILL BE HALF SCALE

SUBCONTRACTOR SHALL VERIFY ALL PLANS & EXISTING DIMENSIONS & CONDITIONS ON THE JOB SITE & SHALL IMMEDIATELY NOTIFY THE ENGINEER IN WRITING OF ANY DISCREPANCIES BEFORE PROCEEDING WITH THE WORK OR BE RESPONSIBLE FOR SAME.



PROJECT INFORMATION	
POLE OWNER	OWNER: EXTENET SYSTEMS CA, LLC ADDRESS: 2000 CROW CANYON PL., SUITE 210 SAN RAMON, CA 94583 PHONE: -
APPLICANT	COMPANY: EXTENET SYSTEMS (CALIFORNIA), LLC CONTACT: MATTHEW YERGOVICH ADDRESS: 2000 CROW CANYON PLACE, SUITE 210 SAN RAMON, CA 94583 PHONE: (415) 596-3474 E-MAIL: MYERGOVICH@EXTENETSYSTEMS.COM

ENGINEER	
COMPANY: BLACK & VEATCH ENGINEER: AARON EVANS PHONE: (952) 896-0751 E-MAIL: EVANS@BVB.COM	COMPANY: BLACK & VEATCH ENGINEER: AARON EVANS PHONE: (952) 896-0751 E-MAIL: EVANS@BVB.COM
AGENT	COMPANY: BLACK & VEATCH CONTACT: ANA GOMEZ ADDRESS: 2999 OAK ROAD, WALKUT CREEK, CA 94597 PHONE: (913) 458-9148 E-MAIL: GOMEZ@BARGO@BVB.COM
PROJECT DATA	LATITUDE: 37.76457 LONGITUDE: -122.187749 POLE #: 110123082 ELEVATION: NA ZONING JURISDICTION: CITY OF OAKLAND ZONING DISTRICT: RD-1 NEAREST A.P.N.: 39-3295-28 OCCUPANCY: U, UNMANNED CONSTRUCTION TYPE: POLE ATTACHMENTS TO A WOOD UTILITY FACILITY IS UNMANNED AND NOT FOR HUMAN HABITATION. THIS PROJECT IS EXEMPT.

CODE COMPLIANCE

ALL WORK AND MATERIALS SHALL BE PERFORMED AND INSTALLED IN ACCORDANCE WITH THE REQUIREMENTS OF THE FOLLOWING CODES AS ADOPTED BY THE LOCAL GOVERNING AUTHORITIES (AS APPLICABLE). NOTHING IN THESE PLANS IS TO BE CONSTRUED TO PERMIT WORK NOT CONTAINING TO THESE CODES.

- IBC - 2012
- INTERNATIONAL BUILDING REGULATIONS CODE - 2013
- CALIFORNIA GENERAL ORDER 95
- CALIFORNIA MECHANICAL CODE 2013
- CALIFORNIA PLUMBING CODE 2013
- CALIFORNIA ELECTRICAL CODE 2013
- CITY AND/OR COUNTY ORDINANCES
- 2012 INTERNATIONAL FIRE CODE
- BUILDING OFFICIALS AND CODE ADMINISTRATORS (BOCA)
- EFFECTIVE UNTIL JANUARY 1ST, 2017

PROJECT DESCRIPTION

THESE DRAWINGS DEPICT THE INSTALLATION OF A WIRELESS TELECOMMUNICATIONS NODE IN THE PUBLIC RIGHT OF WAY, HARDWARE AND ANCILLARY EQUIPMENT TO BE INSTALLED AS DESCRIBED HEREIN.

GENERAL PROJECT NOTES

- PRIOR TO SUBMITTING A BID, THE CONTRACTOR SHALL FAMILIARIZE HIMSELF/HIMSELF WITH THE SCOPE OF WORK AND ALL CONDITIONS AFFECTING THE NEW PROJECT.
- CONTRACTOR SHALL VERIFY ALL FIELD CONDITIONS AND AS INDICATED ON THESE CONSTRUCTION DOCUMENTS CAN BE ACCOMPLISHED AS SHOWN PRIOR TO COMMENCEMENT OF ANY WORK.
- ALL FIELD MODIFICATIONS BEFORE, DURING OR AFTER CONSTRUCTION SHALL BE PROVIDED IN WRITING BY AN EXTENET SYSTEMS REPRESENTATIVE.
- INSTALL ALL EQUIPMENT AND MATERIALS PER THE MANUFACTURER'S RECOMMENDATIONS, UNLESS INDICATED OTHERWISE.
- NOTIFY EXTENET SYSTEMS, IN WRITING, OF ANY MAJOR CONDITIONS AFFECTING THE CONSTRUCTION DOCUMENTS, INCLUDING ANY CHANGES TO THE CONTRACT DOCUMENTS, AS EARLY AS POSSIBLE, AND REQUESTING WRITTEN APPROVAL FROM AN EXTENET SYSTEMS REPRESENTATIVE, AND ADJUSTING THE BID ACCORDINGLY.
- CONTRACTORS SHALL BE SOLELY RESPONSIBLE FOR ALL CONSTRUCTION MEANS, METHODS, TECHNIQUES, SEQUENCES AND PROCEDURES OF THE WORK UNDER THE CONTRACT.
- CONTRACTOR SHALL PROTECT ALL EXISTING IMPROVEMENTS AND FINISHES THAT ARE TO REMAIN. CONTRACTOR SHALL REPAIR ANY DAMAGE TO EXISTING UTILITIES OR STRUCTURES TO THE SATISFACTION OF AN EXTENET SYSTEMS REPRESENTATIVE.
- CONTRACTOR PLANS TO ILLUSTRATE THE AS BUILT CONDITION OF THE SITE FOLLOWING THE FINAL INSPECTION BY EXTENET OR TUMBLE. THE CONTRACTOR SHALL PROVIDE EXTENET SYSTEMS WITH ONE COPY OF ALL RED-LINED DRAWINGS.
- VERIFY ALL FINAL EQUIPMENT WITH AN EXTENET SYSTEMS REPRESENTATIVE. THE CONTRACTOR SHALL BE RESPONSIBLE FOR INSTALLATION AND THEIR FINAL LOCATION ARE TO BE APPROVED BY EXTENET SYSTEMS. THE CONTRACTOR SHALL BE RESPONSIBLE FOR OBTAINING ALL NECESSARY PERMITS AND CLEARANCES REQUIRED BY OTHERS RELATED TO SAID INSTALLATIONS.

UNDERGROUND SERVICE ALERT

UTILITIES PROTECTION CENTER, INC.
811

48 hours before you dig

extenet reconnectivity
everywhere

INTERNAL REVIEW

CONSTRUCTION SIGNATURE _____ DATE _____

RF SIGNATURE _____ DATE _____

LEGAL ESTATE SIGNATURE _____ DATE _____

BLACK & VEATCH
BLACK & VEATCH CORPORATION
2999 OAK ROAD
SUITE 400
WALNUT CREEK, CA 94597

THESE DRAWINGS USE COPYWRITERS AND ARE THE PROPERTY OF BLACK & VEATCH. NO REPRODUCTION OR USE OF THE DRAWINGS IS PROHIBITED WITHOUT WRITTEN CONSENT BY BLACK & VEATCH.

PROJECT NO	DRAWN BY	CHECKED BY
192417.4441	DMS	GAC

REV	DATE	DESCRIPTION
B	09/27/16	ISSUED FOR REVIEW
A	09/13/16	ISSUED FOR REVIEW

EXTENET SYSTEMS (CA) LLC
2000 CROW CANYON PLACE
SUITE 210
SAN RAMON, CA 94583

SITE ADDRESS
ADJACENT TO (IN PROW)
2400 66TH AVENUE
OAKLAND, CA 94605

SHEET TITLE
TITLE SHEET

SHEET NUMBER
T-1

IT IS A VIOLATION OF LAW FOR ANY PERSON, UNLESS A LICENSED PROFESSIONAL ENGINEER, TO ALTER THIS DOCUMENT.

PRELIMINARY

GENERAL NOTES

1. THESE NOTES SHALL BE CONSIDERED A PART OF THE WRITTEN SPECIFICATIONS, CONTRACT AND CONSTRUCTION DOCUMENTS.
2. THE WORK SHALL INCLUDE FURNISHING MATERIALS, EQUIPMENT, APPURTENANCES, AND LABOR NECESSARY TO COMPLETE ALL INSTALLATIONS AS INDICATED ON THESE PLANS AND IN THE CONTRACT DOCUMENTS.
3. PRIOR TO THE SUBMISSION OF BIDS, THE CONTRACTOR(S) SHALL VISIT THE JOB SITE(S) AND BE RESPONSIBLE FOR OBTAINING ALL NECESSARY PERMITS AND APPROVALS. THE CONTRACTOR(S) SHALL BE RESPONSIBLE FOR OBTAINING ALL NECESSARY PERMITS AND APPROVALS FROM THE IMPLEMENTATION ENGINEER AND ARCHITECT/ENGINEER PRIOR TO BID SUBMITTAL.
4. THE CONTRACTOR SHALL RECEIVE WRITTEN AUTHORIZATION TO PROCEED ON ANY WORK NOT CLEARLY DEFINED OR IDENTIFIED IN THE CONTRACT AND CONSTRUCTION DOCUMENTS BEFORE STARTING ANY WORK.
5. ALL WORK SHALL BE INSTALLED AND MAINTAINED IN ACCORDANCE WITH ALL APPLICABLE CODES, REGULATIONS, AND ORDINANCES, INCLUDING APPLICABLE NATIONAL AND UTILITY COMPANY SPECIFICATIONS.
6. THE CONTRACTOR SHALL INSTALL ALL EQUIPMENT AND MATERIALS IN ACCORDANCE WITH MANUFACTURER'S INSTRUCTIONS AND ALL APPLICABLE CODES, REGULATIONS, AND ORDINANCES. THE CONTRACTOR SHALL OBTAIN ALL NECESSARY PERMITS AND APPROVALS FROM THE IMPLEMENTATION ENGINEER AND ARCHITECT/ENGINEER PRIOR TO PROCEEDING.
7. THE CONTRACTOR SHALL BE SOLELY RESPONSIBLE FOR ALL CONSTRUCTION MEANS, METHODS, TECHNIQUES, CONTRACT INCLUDING CONTRACT AND CONSTRUCTION WITH THE IMPLEMENTATION ENGINEER AND WITH THE AUTHORIZED REPRESENTATIVE OF ANY OUTSIDE POLE OR PROPERTY OWNER.
8. THE CONTRACTOR SHALL BE RESPONSIBLE FOR PROTECTING ALL EXISTING UTILITIES, INCLUDING BUT NOT LIMITED TO POWER LINES, TELEPHONE LINES, AND OTHER UTILITIES, AND SHALL BE RESPONSIBLE FOR THE PROTECTION OF THE WORK, REPAIR ANY DAMAGE THAT OCCURRED DURING CONSTRUCTION TO THE SATISFACTION OF THE IMPLEMENTATION ENGINEER AND ARCHITECT/ENGINEER.
9. CONTRACTOR IS TO KEEP THE GENERAL USER, DESIGN, WORKER, AND DESIGNER OF ALL UTILITIES, FURNISH, AND REMOVE EQUIPMENT NOT SPECIALLY AS REMAINING ON THE PROPERTY OF ALL UTILITIES, CLEAR CONSTRUCTION DAILY.
10. PLANS ARE INTENDED TO BE DIAGNOSTIC ONLY AND SHOULD NOT BE SCALED UNLESS OTHERWISE NOTED. THE CONTRACTOR SHALL OBTAIN ALL NECESSARY PERMITS AND APPROVALS FROM THE IMPLEMENTATION ENGINEER AND ARCHITECT/ENGINEER PRIOR TO PROCEEDING.
11. THE CONTRACTOR SHALL OBTAIN ALL NECESSARY PERMITS AND APPROVALS FROM THE IMPLEMENTATION ENGINEER AND ARCHITECT/ENGINEER PRIOR TO PROCEEDING.
12. THE CONTRACTOR SHALL NOTIFY UNDERGROUND SERVICE ALERT (800) 227-2600, AT LEAST TWO WORKING DAYS PRIOR TO THE START OF ANY EXCAVATION.

DEFINITIONS

1. "TYPICAL" OR "TYP" MEANS THAT THIS ITEM IS SUBSTANTIALLY THE SAME AS THE SIMILAR CONDITIONS "TYP" SHALL BE UNDERSTOOD TO MEAN "TYPICAL WHERE OCCURS" AND SHALL NOT BE CONSIDERED AS WITHOUT EXCEPTION OR CONSIDERATION OF SPECIFIC CONDITIONS.
2. "SIMILAR" MEANS COMPARABLE TO CHARACTERISTICS FOR THE CONDITION NOTED. VERIFY DIMENSIONS AND CONSTRUCTION ON PLAN.
3. "CONFORMANCE" MEANS CONFORMANCE WITH THE REFERENCED STANDARDS, BY EXISTING CONDITIONS, BY GENERALLY ACCEPTED CONSTRUCTION PRACTICES, OR BY OTHERWISE SPECIFIED CONDITIONS.
4. "AUGER" MEANS ACCURATELY LOCATE FINISH FACES OF MATERIALS IN THE SAME PLANE.
5. THE TERM "FIELD" OR "FIELD" MEANS ANY FIELD WITH ENGINEER AND ARCHITECT/ENGINEER APPROVAL. THE CONTRACTOR SHALL OBTAIN ALL NECESSARY PERMITS AND APPROVALS FROM THE IMPLEMENTATION ENGINEER AND ARCHITECT/ENGINEER PRIOR TO PROCEEDING.
6. WHERE THE WORDS "OR EQUAL" OR WORDS OF SIMILAR INTENT FOLLOW A MATERIAL SPECIFICATION, THEY SHALL MEAN THAT THE CONTRACTOR SHALL OBTAIN ALL NECESSARY PERMITS AND APPROVALS FROM THE IMPLEMENTATION ENGINEER AND ARCHITECT/ENGINEER PRIOR TO PROCEEDING.
7. FURNISH - SUPPLY ONLY. OTHERS TO INSTALL. INSTALL ITEMS FURNISHED BY OTHERS PROVIDE, FURNISH AND INSTALL.

FIELD WELDING NOTES:

1. WELDING TO BE PERFORMED BY AWS-CERTIFIED WELDER FOR THE TYPE OF AND POSITION INDICATED. ALL WORK MUST BE IN CONFORMANCE WITH LATEST EDITION OF AWS D1.1.
2. GRIND SURFACES TO BE WELDED WITH A SILICON CARBIDE WHEEL PRIOR TO WELDING TO REMOVE ALL OXIDE AND BURRS WHICH MAY OTHERWISE BE CONSUMED IN THE WELD METAL. APPLY ANTI-SPATTER COMPOUND AFTER GRINDING.
3. WELDING TECHNIQUE MUST MINIMIZE TEMPERATURE RISE ON THE INSIDE SURFACE OF THE POLE AND ALSO VOLATILE ANY REMAINING ZINC WITHIN THE BASE METAL WITH MINIMUM SPATTER. USE AN E70 (LOW HYDROGEN) ELECTRODE AND FOLLOW ALL MANUFACTURER'S INSTRUCTIONS FOR STORAGE AND USE OF ELECTRODES. WARE REMOVING ELECTRODES FROM MANUFACTURER'S PACKAGING UNTIL READY FOR IMMEDIATE USE.
4. WELDING MAY PRODUCE TOXIC FUMES. REFER TO ANSI STANDARD Z49.1 "SAFETY IN WELDING AND CUTTING" FOR PROPER PRECAUTIONS.
5. UPON COMPLETION OF WELDING, APPLY GALVA-STEEL ZINC COATING TO ALL UNPROTECTED SURFACES. APPLY NECESSARY, APPLY A FINAL COAT OF COMPATIBLE PAINT TO MATCH SURROUNDING SURFACES.

ANTENNA MOUNTING

1. DESIGN AND CONSTRUCTION OF ANTENNA SUPPORTS SHALL CONFORM TO CURRENT ANSI/TIA-222 OR IEEE-961 STANDARDS.
2. ALL STEEL MATERIALS SHALL BE GALVANIZED AFTER FABRICATION IN ACCORDANCE WITH ASTM A123 "ZINC COATING (HOT-DIP) ON IRON AND STEEL PRODUCTS UNLESS NOTED OTHERWISE."
3. ALL BOLTS, ANCHORS AND MISCELLANEOUS HARDWARE SHALL BE GALVANIZED IN ACCORDANCE WITH ASTM A153 "ZINC-COATING (HOT-DIP) ON IRON AND STEEL HARDWARE," UNLESS NOTED OTHERWISE.
4. DAMAGED GALVANIZED SURFACES SHALL BE REPAIRED BY COLD GALVANIZING IN ACCORDANCE WITH ASTM A780 "ZINC-COATING (HOT-DIP) ON IRON AND STEEL HARDWARE," UNLESS NOTED OTHERWISE.
5. ALL ANTENNA MOUNTS SHALL BE INSTALLED WITH LOCK NUTS, DOUBLE NUTS AND SHALL BE TORQUED TO MANUFACTURER'S RECOMMENDATIONS.
6. CONTRACTOR SHALL INSTALL ANTENNA PER MANUFACTURER'S RECOMMENDATION FOR INSTALLATION AND GROUNDING.
7. PRIOR TO SETTING ANTENNA MOUNTS AND DOWNLINES, ANTENNA CONTRACTOR SHALL CHECK THE ANTENNA MOUNTS AND DOWNLINES ARE CORRECTLY INSTALLED AND ORIENTED WITHIN +/- 5% AS DEFINED BY THE REFS. ANTENNA DOWNLINES SHALL BE WITHIN +/- 0.5% AS DEFINED BY THE REFS.

TORQUE REQUIREMENTS

1. ALL RF CONNECTIONS SHALL BE TIGHTENED BY A TORQUE WRENCH.
2. ALL RF CONNECTIONS, GROUNDING HARDWARE AND ANTENNA HARDWARE SHALL HAVE A TORQUE MARK INSTALLED IN A CONTINUOUS STRAIGHT LINE FROM BOTH SIDES OF THE CONNECTION.
3. A RF CONNECTION BOTH SIDES OF THE CONNECTOR.
4. GROUNDING AND ANTENNA HARDWARE ON THE NUT SIDE STARTING FROM THE THREADS TO THE SOLD SURFACE. EXAMPLE OF SOLD SURFACE: GROUND BAR, ANTENNA BRACKET METAL.
5. ALL 8M ANTENNA HARDWARE SHALL BE TIGHTENED TO 9 LB-FT (12 NM).
6. ALL 12M ANTENNA HARDWARE SHALL BE TIGHTENED TO 4.3 LB-FT (58 NM).
7. ALL GROUNDING HARDWARE SHALL BE TIGHTENED UNTIL THE LOCK WASHER COLLAPSES AND THE GROUNDING HARDWARE IS NO LONGER LOOSE.
8. ALL DIN TYPE CONNECTIONS SHALL BE TIGHTENED TO 18-22 LB-FT (24.4 - 29.8 NM).
9. ALL N TYPE CONNECTIONS SHALL BE TIGHTENED TO 15-20 LB-IN (1.7 - 2.3 NM).

ROW UTILITY POLE CONSTRUCTION NOTES

1. NO BOLT THROUGH TO PROTRUDE MORE THAN 1"-1/2" (38MM).
2. ALL HOLES LEFT IN POLE FROM REARRANGEMENT OF CLIMBERS.
3. ALL CLIMB STEPS NEXT TO CONDUIT SHALL HAVE EXTENDED STEPS.
4. CABLE NOT TO INTERFERE 15" (381MM) CLEAR SPACE OFF POLE FACE (12.00).
5. 90 SHORT SWEEPS UNDER ANTENNA ARM. ALL CABLES MUST ONLY TRANSITION ON THE INSIDE OR BOTTOM OF PANS (NO CABLE ON TOP OF PANS).
6. USE 90 CONNECTOR AT CABLE CONNECTION TO ANTENNAS.
7. PLACE 90S ON ARM WITH EXPOSURE 6" (152.4) FROM TRANSMIT ANTENNA, WHICH IS 24" (610) AWAY FROM CENTER OF POLE.
8. USE 1/2" (12.7) [0.13M] CABLE AT CONDUITS UNLESS OTHERWISE SPECIFIED.
9. FILL VOID AROUND CABLES ON ANTENNA OPENING WITH FOAM SEALANT TO PREVENT WATER INTRUSION.

NODE SITE POWER SHUT-DOWN PROCEDURES

1. FOR NON EMERGENCY/SCHEDULED POWER SHUT DOWN
 - A. CALL EXTENET SYSTEMS NOC (NETWORK OPERATIONS CENTER) (866)989-5327
 - B. 24 HOURS PRIOR TO SCHEDULED POWER SHUT OFF
 - C. PROVIDE THE FOLLOWING INFORMATION
 - NDC SITE NUMBER IDENTIFIED ON SITE NUMBERING STICKER
 - YOUR NAME AND REASON FOR POWER SHUTOFF
 - PROVIDE DURATION OF OUTAGE
 - D. FULL DISCONNECT HANDLE TO "OFF" POSITION
 - E. POWER SHUT OFF VERIFICATION WITH APPROVED POSE PROCEDURES
 - F. NOTIFY EXTENET NOC UPON COMPLETION OF WORK
2. EMERGENCY POWER SHUT OFF
 - A. CALL EXTENET SYSTEMS NOC (NETWORK OPERATIONS CENTER) (866)989-5327
 - B. PROVIDE THE FOLLOWING INFORMATION
 - NDC SITE NUMBER IDENTIFIED ON SITE NUMBERING STICKER
 - YOUR NAME AND REASON FOR POWER SHUTOFF
 - PROVIDE DURATION OF OUTAGE
 - C. FULL DISCONNECT HANDLE TO "OFF" POSITION
 - D. POWER SHUT OFF VERIFICATION WITH APPROVED POSE PROCEDURES
 - E. NOTIFY EXTENET NOC UPON COMPLETION OF WORK
 - F. REINSTALL LOCK ON POWER HANDLE

LEGEND

EXOTHERMIC CONNECTION
MECHANICAL CONNECTION
CHEMICAL ELECTROLYTIC GROUNDING SYSTEM
TEST CHEMICAL ELECTROLYTIC GROUNDING SYSTEM
EXOTHERMIC BAR WITH INSPECTION SLEEVE
GROUNDING BAR
GROUNDING ROD
TEST GROUND ROD WITH INSPECTION SLEEVE
CHAINLINK FENCE
WOOD/ROUGHT IRON FENCE
WALL STRUCTURE
LEASE AREA
PROPERTY LINE (PL)
SETBACKS
WATER LINE
UNDERGROUND POWER
UNDERGROUND TELCO
UNDERGROUND FIBER
OVERHEAD POWER
OVERHEAD TELCO
UNDERGROUND TELCO/POWER
ABOVE GROUND POWER
ABOVE GROUND TELCO
ABOVE GROUND TELCO/POWER
SECTION REFERENCE
DETAIL REFERENCE

extenet inc.
connectivity
SYSTEMS

INTERNAL REVIEW

CONSTRUCTION SIGNATURE _____ DATE _____
RF SIGNATURE _____ DATE _____
REAL ESTATE SIGNATURE _____ DATE _____

BLACK & VEATCH
BLACK & VEATCH CORPORATION
2935 OAK ROAD
SUITE 480
WALNUT CREEK, CA 94597

THESE DRAWINGS ARE CONSIDERED AND ARE THE PROPERTY OF BLACK & VEATCH. ANY REPRODUCTION OR USE OF THE DRAWINGS WITHOUT THE WRITTEN CONSENT OF BLACK & VEATCH IS PROHIBITED.

PROJECT NO. DRAWN BY CHECKED BY
192417.4441 DMS GAC

REV. DATE DESCRIPTION
B 09/27/16 ISSUED FOR REVIEW
A 09/27/16 ISSUED FOR REVIEW

IT IS A VIOLATION OF LAW FOR ANY PERSON, UNLESS A LICENSED PROFESSIONAL ENGINEER, TO ALTER THIS DOCUMENT.

EXTENET SYSTEMS (CA) LLC
2000 CROW CANYON PLACE
SAN RAMON, CA 94583

SITE ADDRESS
ADJACENT TO (IN PROW)
2400 66TH AVENUE
OAKLAND, CA 94605

SHEET TITLE
GENERAL NOTES
AND LEGEND

SHEET NUMBER
GN-1

PRELIMINARY

GENERAL NOTES AND LEGEND



INTERNAL REVIEW	DATE
CONSTRUCTION SIGNATURE	DATE
RF SIGNATURE	DATE
REAL ESTATE SIGNATURE	DATE

BLACK & VEATCH
 BLACK & VEATCH CORPORATION
 3500 RIVERFRONT DRIVE
 SUITE 1400
 WALNUT CREEK, CA 94597

THESE DRAWINGS ARE COPYRIGHTED AND ALL RIGHTS ARE RESERVED. ANY REPRODUCTION OR USE OF THE DRAWINGS WITHOUT THE WRITTEN CONSENT OF BLACK & VEATCH IS PROHIBITED.

PROJECT NO	192417.4441
DRAWN BY	DMS
CHECKED BY	GAC

REV	DATE	DESCRIPTION
B	09/27/14	ISSUED FOR REVIEW
A	09/10/14	ISSUED FOR PERMIT

PRELIMINARY

IT IS A VIOLATION OF LAW FOR ANY PERSON, UNLESS THEY ARE ACTING UNDER THE DIRECTION OF A LICENSED PROFESSIONAL ENGINEER, TO ALTER THIS DOCUMENT.

EXTENET SYSTEMS (CA) LLC
 2000 CROW CANTON PLACE
 SUITE 210
 SAN RAMON, CA 94583

SITE ADDRESS
 ADJACENT TO (IN PROW)
 2400 66TH AVENUE
 OAKLAND, CA 94605

SHEET TITLE
 OVERALL SITE PLAN

SHEET NUMBER
C-1

THIS DRAWING IS NOT A SITE SURVEY. THE PURPOSE OF THIS DRAWING IS TO DEVELOP A PRELIMINARY SITE PLAN FOR THE PROPOSED PROJECT AND TO SHOW THE RELATIONSHIP OF THE PROJECT TO ADJACENT PROPERTIES. P.L.O.W. MEASUREMENTS ARE APPROXIMATIONS.

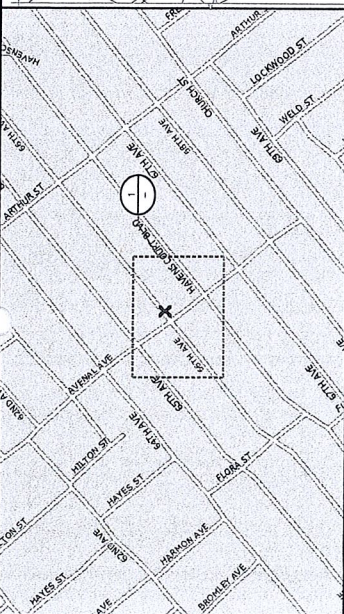
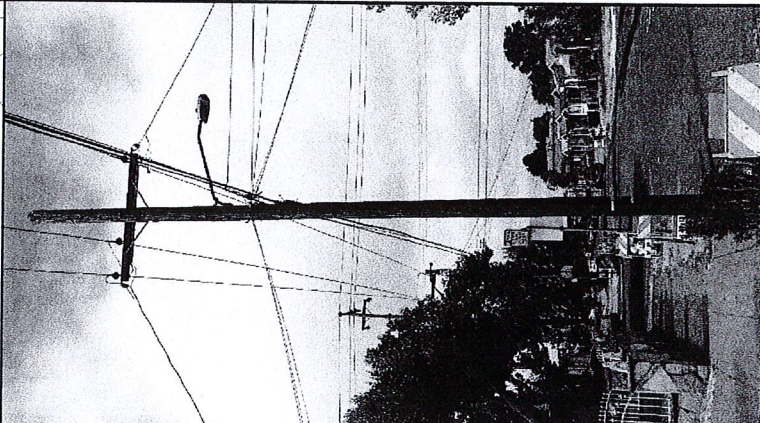
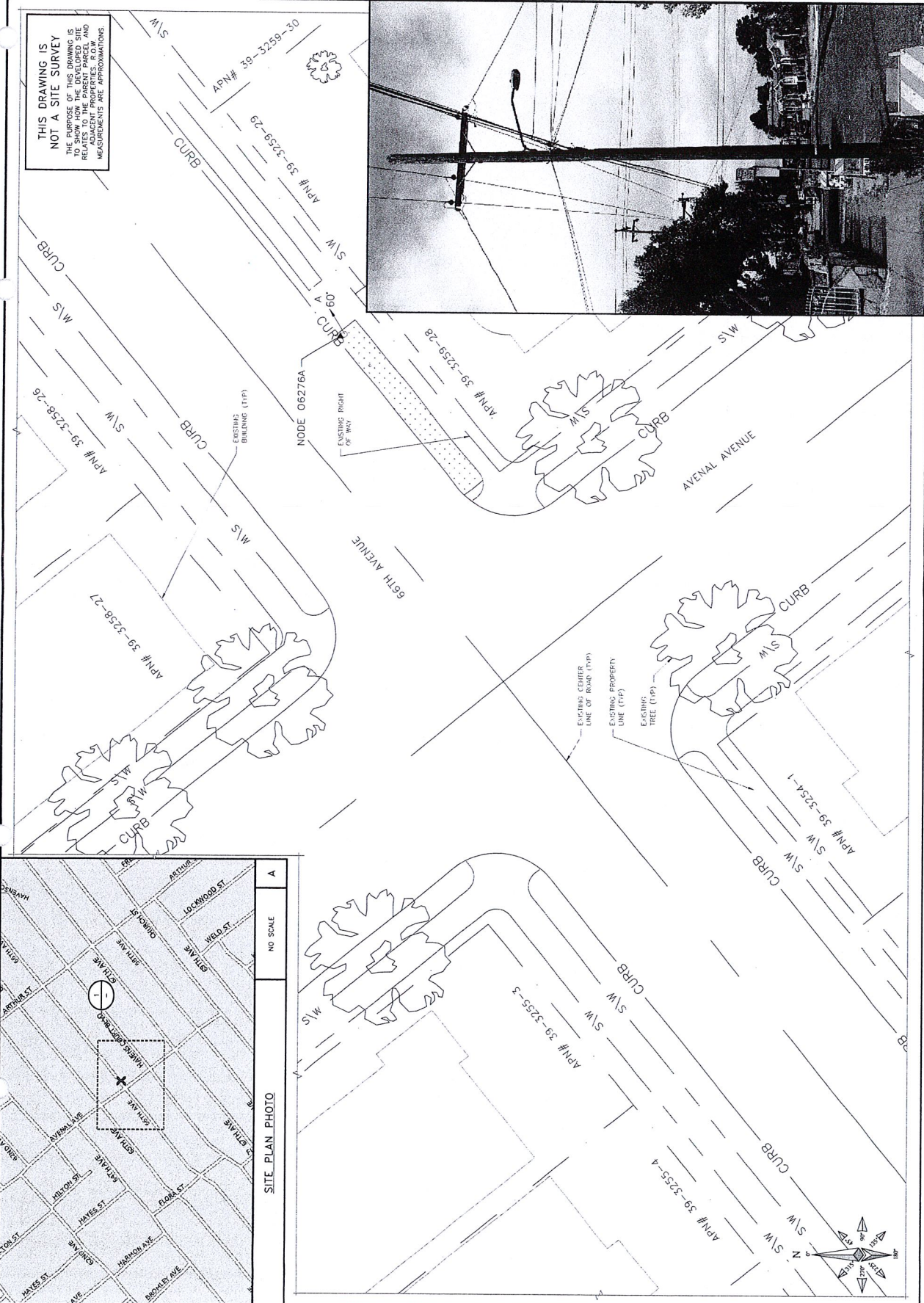

OVERALL SITE PLAN

THESE DRAWINGS ARE COPYRIGHTED AND ARE THE PROPERTY OF BLACK & VEATCH. ANY REPRODUCTION OR USE OF THE INFORMATION CONTAINED WITHIN SAID DRAWINGS WITHOUT THE WRITTEN CONSENT BY BLACK & VEATCH IS STRICTLY PROHIBITED.

PROJECT NO	DRAWN BY	CHECKED BY	DMS	GNC
192417.444.1				

REV	DATE	DESCRIPTION
B	09/27/16	ISSUED FOR REVIEW
A	09/13/16	ISSUED FOR REVIEW

PRELIMINARY

IT IS A VIOLATION OF LAW FOR ANY PERSON UNLESS THEY ARE ACTING UNDER THE DIRECTION OF A LICENSED PROFESSIONAL ENGINEER TO ALTER THIS DOCUMENT.

EXTENET SYSTEMS (CA) LLC
2000 CROW CANYON PLACE
SUITE 210
SAN RAMON, CA 94583

SITE ADDRESS
ADJACENT TO (IN PROW)
2400 66TH AVENUE
OAKLAND, CA 94605

SHEET TITLE
UTILITY POLE ELEVATIONS AND RISER DETAILS

SHEET NUMBER
C-2

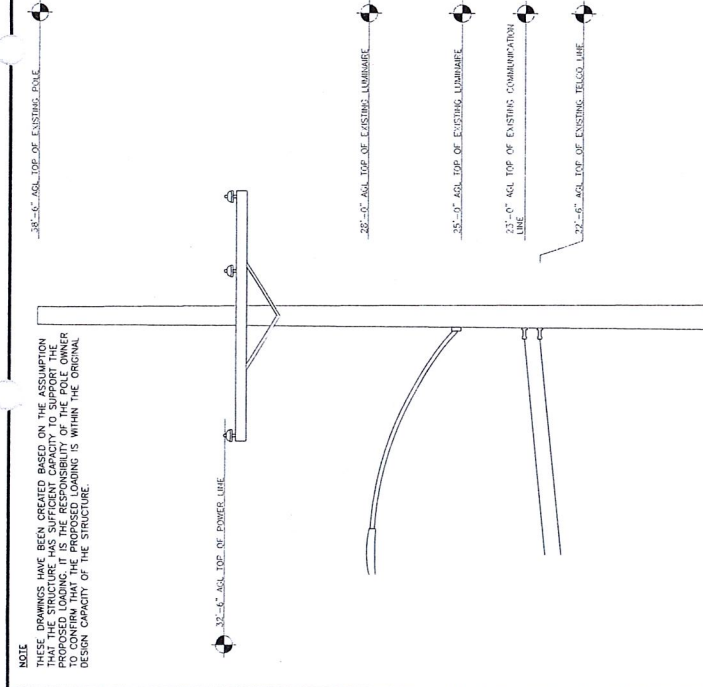
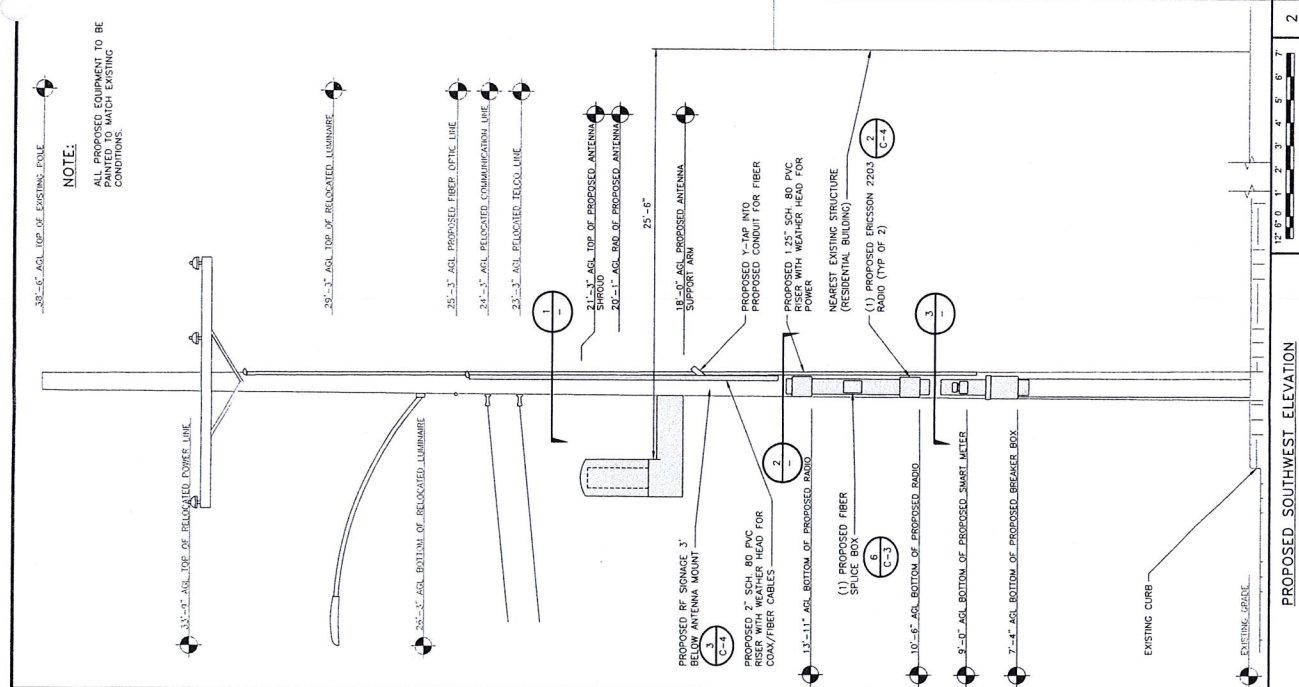
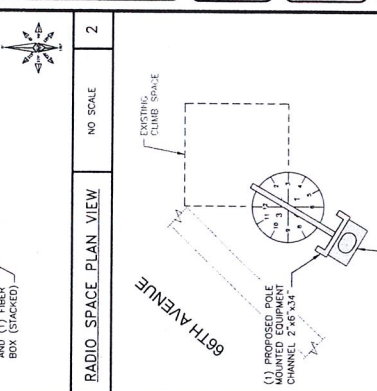
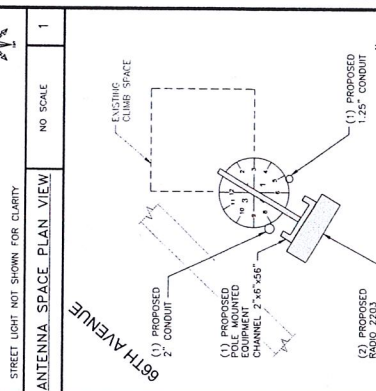
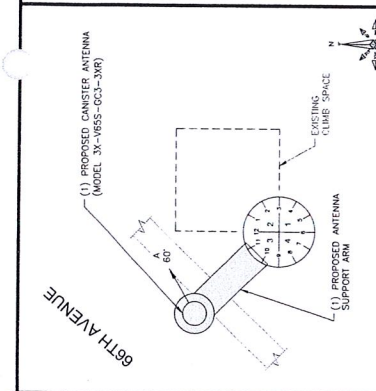

- CARRIER MAKE-READY**
- CONTRACTOR TO INSTALL (1)-7.9" x 2.15" CANISTER ANTENNA W/ ANGLARY ELECTRONICS AND HARDWARE ON PROPOSED ANTENNA
 - CONTRACTOR TO INSTALL (2) RADIOS w/ ANGLARY ELECTRONICS AND HARDWARE ON PROPOSED CHANNEL MOUNTS FOR COAX AND FIBER CABLES
 - CONTRACTOR TO INSTALL (1) BREAKER BOX/LOAD CENTER ON PROPOSED CHANNEL MOUNTS
 - CONTRACTOR TO INSTALL (1) POLE SMART METERS
 - CONTRACTOR TO INSTALL (1) 1.25" SCH. 80 PVC RISER WITH WEATHERHEAD FOR POWER
 - CONTRACTOR TO RELOCATE EXISTING TELCO LINE FROM 22'-6" TO 21'-3"
 - EXTENET APPROVED CONTRACTOR TO RELOCATE EXISTING COMMUNICATION LINE TO 24'-3"
 - EXTENET APPROVED CONTRACTOR TO RELOCATE EXISTING POWER LINE TO 25'-0"
 - EXTENET APPROVED CONTRACTOR TO RELOCATE EXISTING LUMINAIRE FROM 25'-0" TO 26'-3"

COMMSCOPE 3X-V655-GC3-3XR

PADLOCK COLOR: LIGHT GREY
 RADIOME MATERIAL: FIBERGLASS, UV RESISTANT
 DIAMETER: 7.9" (200mm)
 HEIGHT: 23.5" (596mm)
 TOTAL WEIGHT (WITHOUT BRACKETS): 7.2 Kg (15.9 LB)
 CONNECTOR INTERFACE: 4.1-9.5 DIN FEMALE
 RF CONNECTOR LOCATION: BOTTOM
 RF CONNECTOR QUANTITY: 6

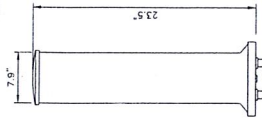

PROPOSED ANTENNA

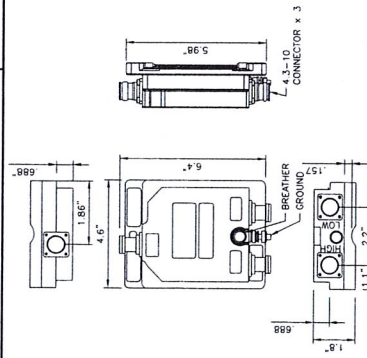

COMMSCOPE CBC 1923-4310/ E11F13P20

NW-CAL-SANFERNIC-TWO
 OPTION-4

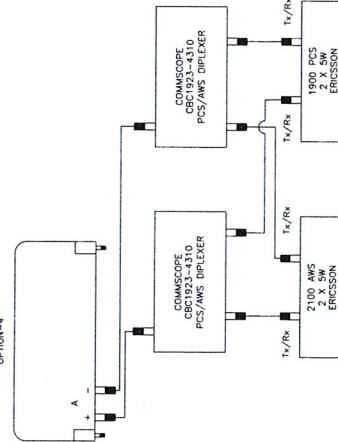

ANTENNA CONFIGURATION

NO SCALE

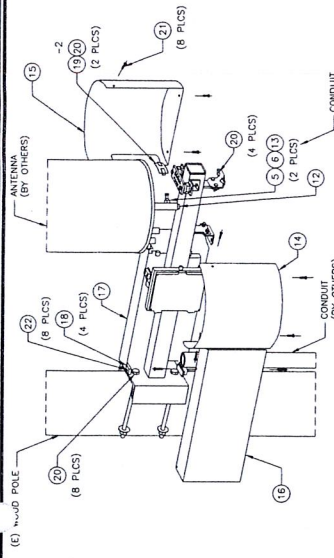

**SIDE ARM ANTENNA MOUNT
 2'-0" STANDOFF FOR WOOD POLE**

NO SCALE

**ISO VIEW
 STANDOFF ASSEMBLY**

(ANTENNA SHROUD NOT SHOWN FOR CLARITY)

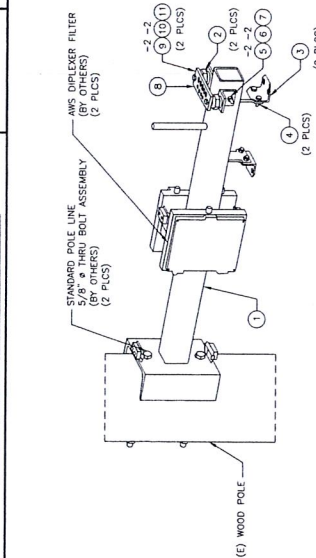

**ISO VIEW
 STANDOFF ASSEMBLY**

**SIDE ARM ANTENNA MOUNT
 2'-0" STANDOFF FOR WOOD POLE**

NO SCALE

MURRAY LW002GRU SPECIFICATION

DIMENSIONS
 LOAD CENTER DEPTH: 3.625"
 LOAD CENTER WIDTH: 5.2"
 LOAD CENTER HEIGHT: 6.25"
 WEIGHT: 4.55 LB
 LOAD CENTER TYPE: MAIN LUG
 MOUNTING TYPE: PLUG IN
 NUMBER OF PHASES: 1
 VOLTAGE (VOLTS): 120/240
 INDOOR/OUTDOOR: OUTDOOR
 ELECTRICAL PRODUCT TYPE: LOAD CENTER

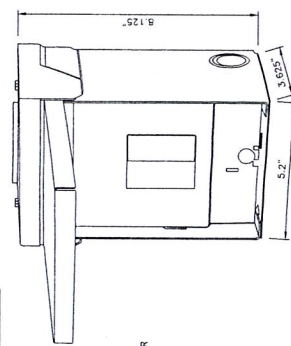

MURRAY LW002GRU

NO SCALE

ITEM #	PART #	DESCRIPTION	QTY	UNIT WT. (lbs)
1	WA-714	STANDOFF ARM ASSEMBLY PARTS / HWHR	1	4.3
2	SS-514	3" X 3/4" / 1/8" X 3/4" - 2" STANDOFF ARM W/ DUNNT	2	0.5
3	SS-516	2" X 3/4" / 1/8" X 3/4" - 2" ANGLE	2	0.4
4	15200	3/8" X 1/2" A307 FULLY THRD ROD / BUT / NUT / W. GALV.	4	0.1
5	41010	3/8" X 1/2" A307-4 HEX NUT, GALV.	2	0.01
6	51000	3/8" X 1/2" A307-4 HEX NUT, GALV.	2	0.01
7	80328	3/8" X 1/2" A307 THRD ROD, GALV.	1	0.19
8	PL-718	BUS BAR ASSEMBLY PARTS / HWHR	1	0.8
9	42010	1/4" X 2" X 1/8" COPPER BUS BAR	4	0.01
10	70217	3/8" X 1/2" A307 FULLY THRD S.S. BOLT	4	0.04
11	90860	3/8" STANDOFF INSULATOR (SS9840)	2	0.1
12	WA-698	ANTENNA / EQUIPMENT MOUNT PARTS / HWHR	1	2.2
13	16250P	3/8" X 1/2" A307 FULLY THRD BOLT, GALV.	2	0.1
14	41010	3/8" X 1/2" A307 LOCK WASHER, GALV.	2	0.01
15	51000	3/8" X 1/2" A307 HEX NUT, GALV.	2	0.02
16	WA-715L	SHROUD ASSEMBLY PARTS / HWHR	1	8
17	WA-715R	14GA X 1/2" X 1/8" X 1/4" 5/8" I.D. E.C. FORMED PLATE W/ DUNNT	1	8
18	PL-1264	14GA X 1/2" X 5/8" X 2" - 0 7/8" E.C. FORMED COVER	1	9.9
19	PL-1267	14GA X 1/2" X 5/8" X 2" - 0 15/16" E.C. FORMED COVER	4	0.3
20	14209-4	1/2" X 1/2" A307 PLATE	4	0.3
21	55500	1/4"-20 U-STYLE SPEED NUT, BLACK PHOSPHATE	2	0.1
22	70217	1/4" X 1/2" SS FLGD BUTT-NUT HD SCKT CAP SCRW	16	0.02
23	70218	1/4" X 1/2" SS FLGD BUTT-NUT HD SCKT CAP SCRW	18	0.02
24	70218	1/4" X 1/2" SS FLGD BUTT-NUT HD SCKT CAP SCRW	18	0.02

TOTAL GALV. WT. = 89lbs

ANTENNA SHROUD PARTS TABLE

NO SCALE

F1-4868-FSS FUSION SPLICE ENCLOSURE

DEPTH: 2 1/8" (D)
 HEIGHT: 6 3/4" (H)
 WIDTH: 4 3/4" (W)

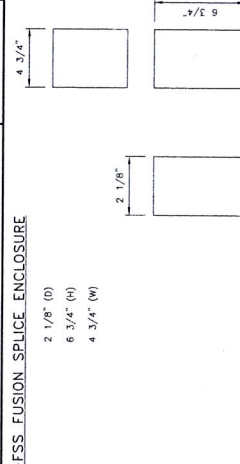

FIBER SPLICE BOX

NO SCALE

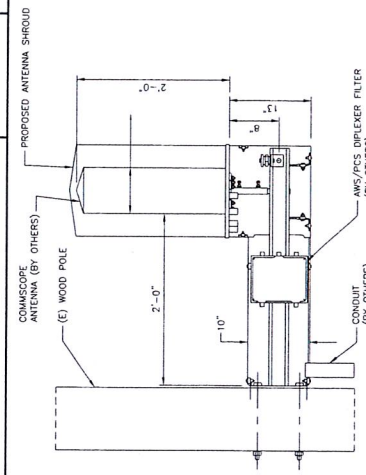

**SIDE ARM ANTENNA MOUNT
 2'-0" STANDOFF FOR WOOD POLE**

NO SCALE



INTERNAL REVIEW DATE
 CONSTRUCTION SIGNATURE DATE
 RF SIGNATURE DATE
 REAL ESTATE SIGNATURE DATE



BLACK & VEATCH
 BLACK & VEATCH CORPORATION
 2999 RIVINGTON ROAD
 SUITE 400
 WALNUT CREEK, CA 94597

THESE DRAWINGS ARE COPYRIGHTED AND ARE THE PROPERTY OF BLACK & VEATCH. NO PART OF THESE DRAWINGS OR THE INFORMATION CONTAINED HEREIN IS TO BE REPRODUCED OR TRANSMITTED IN ANY FORM OR BY ANY MEANS WITHOUT THE WRITTEN CONSENT OF BLACK & VEATCH.

PROJECT NO	192417.4441	DMS	GAC
ISSUED FOR REVIEW	8/27/16		
ISSUED FOR REVIEW	8/13/16		
REV	DATE	DESCRIPTION	

PRELIMINARY

IT IS A VIOLATION OF LAW FOR ANY PERSON UNLESS THEY ARE ACTING UNDER THE DIRECTION OF A LICENSED PROFESSIONAL ENGINEER TO ALTER THIS DOCUMENT.

EXTINET SYSTEMS (CA) LLC
 2000 CROW CANYON PLACE
 SUITE 210
 SAN RAMON, CA 94583

SITE ADDRESS
 ADJACENT TO (IN PROW)
 2400 66TH AVENUE
 OAKLAND, CA 94605

SHEET TITLE
EQUIPMENT DETAILS

SHEET NUMBER

C-3



INTERNAL REVIEW _____ DATE _____
 CONSTRUCTION SIGNATURE _____ DATE _____
 RF SIGNATURE _____ DATE _____
 REAL ESTATE SIGNATURE _____ DATE _____

BLACK & VEATCH
 BLACK & VEATCH CORPORATION
 2500 CROW CANTON PLACE
 SUITE 480
 WALNUT CREEK, CA 94597

THESE DRAWINGS ARE COPYRIGHTED AND
 CONTROLLED BY BLACK & VEATCH. NO
 PART OF THESE DRAWINGS MAY BE REPRODUCED
 OR TRANSMITTED IN ANY FORM OR BY ANY
 MEANS, ELECTRONIC OR MECHANICAL, FOR
 CLIENT. ANY REPRODUCTION OR USE OF THE
 DRAWINGS WITHOUT THE WRITTEN CONSENT
 OF BLACK & VEATCH IS PROHIBITED.

PROJECT NO. 182417.4441
 DRAWN BY: DMS
 CHECKED BY: DAC

REV	DATE	DESCRIPTION
B	09/27/16	ISSUED FOR REVIEW
A	09/23/16	ISSUED FOR REVIEW

PRELIMINARY

IT IS A VIOLATION OF LAW FOR ANY PERSON
 UNLESS THEY ARE ACTING UNDER THE DIRECTION
 OF A REGISTERED PROFESSIONAL ENGINEER
 TO ALTER THIS DOCUMENT.

EXENET SYSTEMS (CA) LLC
 2000 CROW CANTON PLACE
 SUITE 210
 SAN RAMON, CA 94583

SITE ADDRESS
 ADJACENT TO (IN PROW)
 2400 66TH AVENUE
 OAKLAND, CA 94605

SHEET TITLE
 EQUIPMENT DETAILS

SHEET NUMBER
C-4

NOT USED

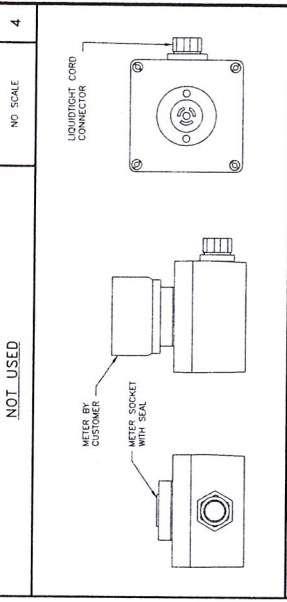

PROPOSED METER ADAPTER

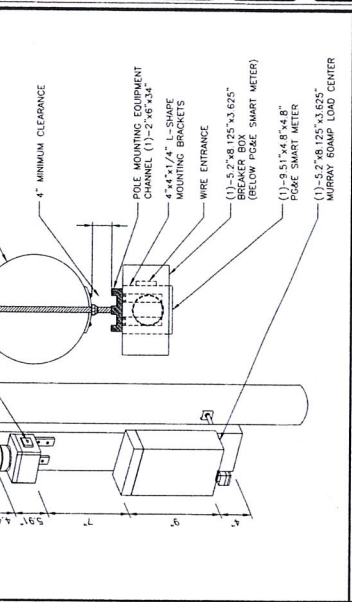
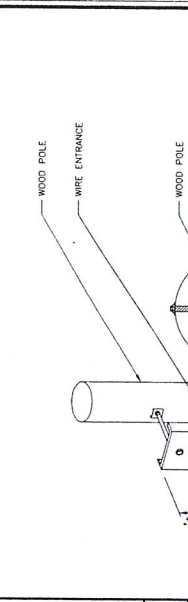

SMART METER/BREAKER BOX DETAIL

NOT USED

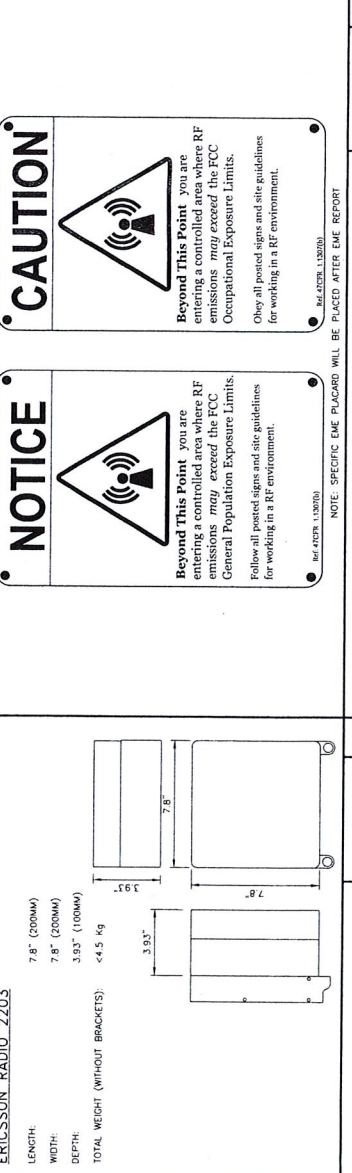

RADIO_SPECIFICATION_DETAIL

Attachment A

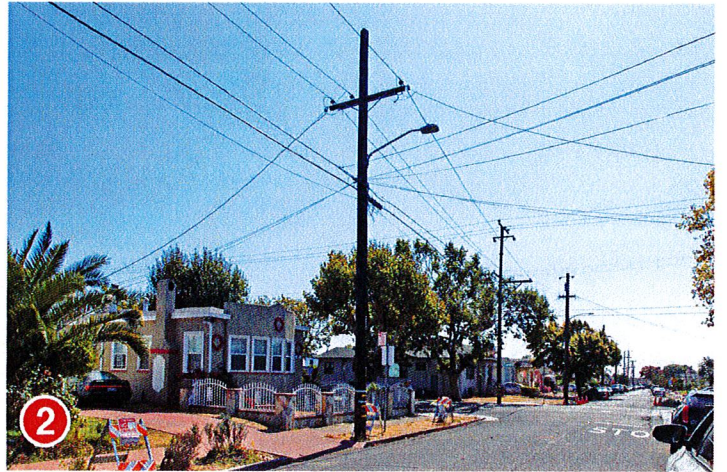
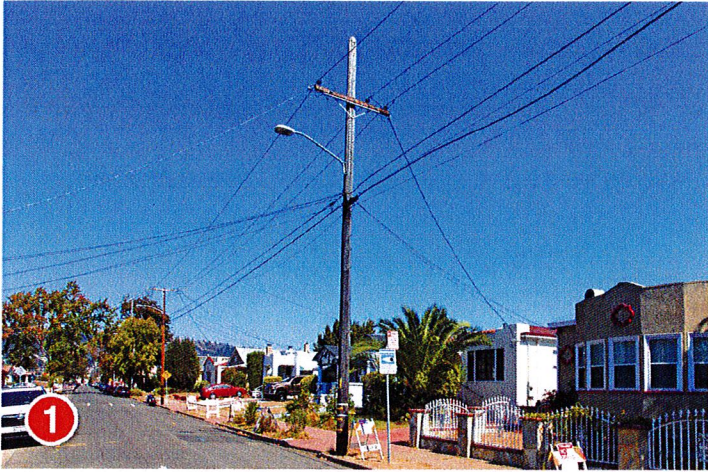





Existing

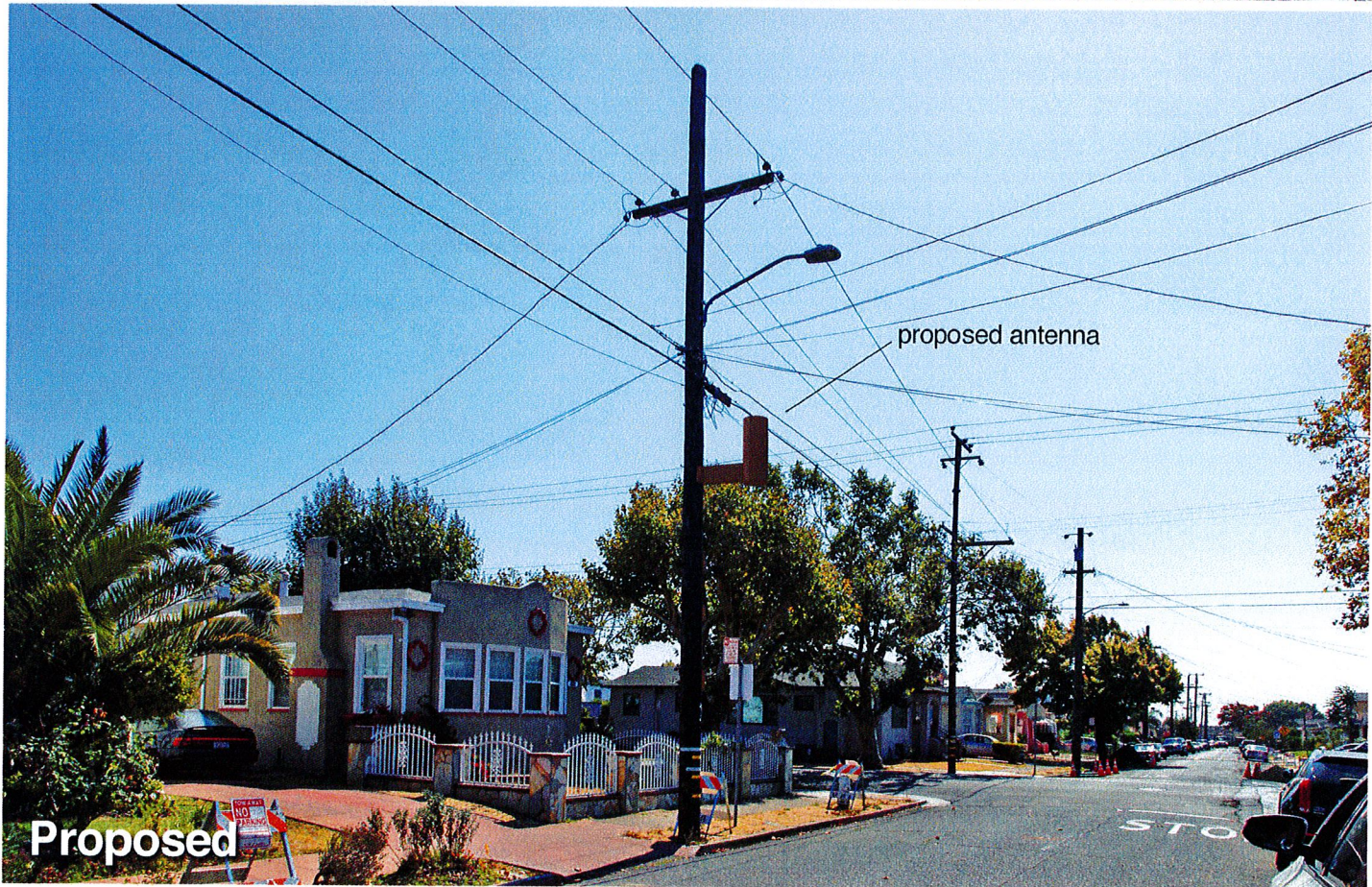

proposed antenna

Proposed



Attachment B

**EXTENET OAKLAND
NODE 06276A
ALTERNATIVE SITE ANALYSIS**

MAP OF ALTERNATIVE POLES EVALUATED FOR NODE 06276A

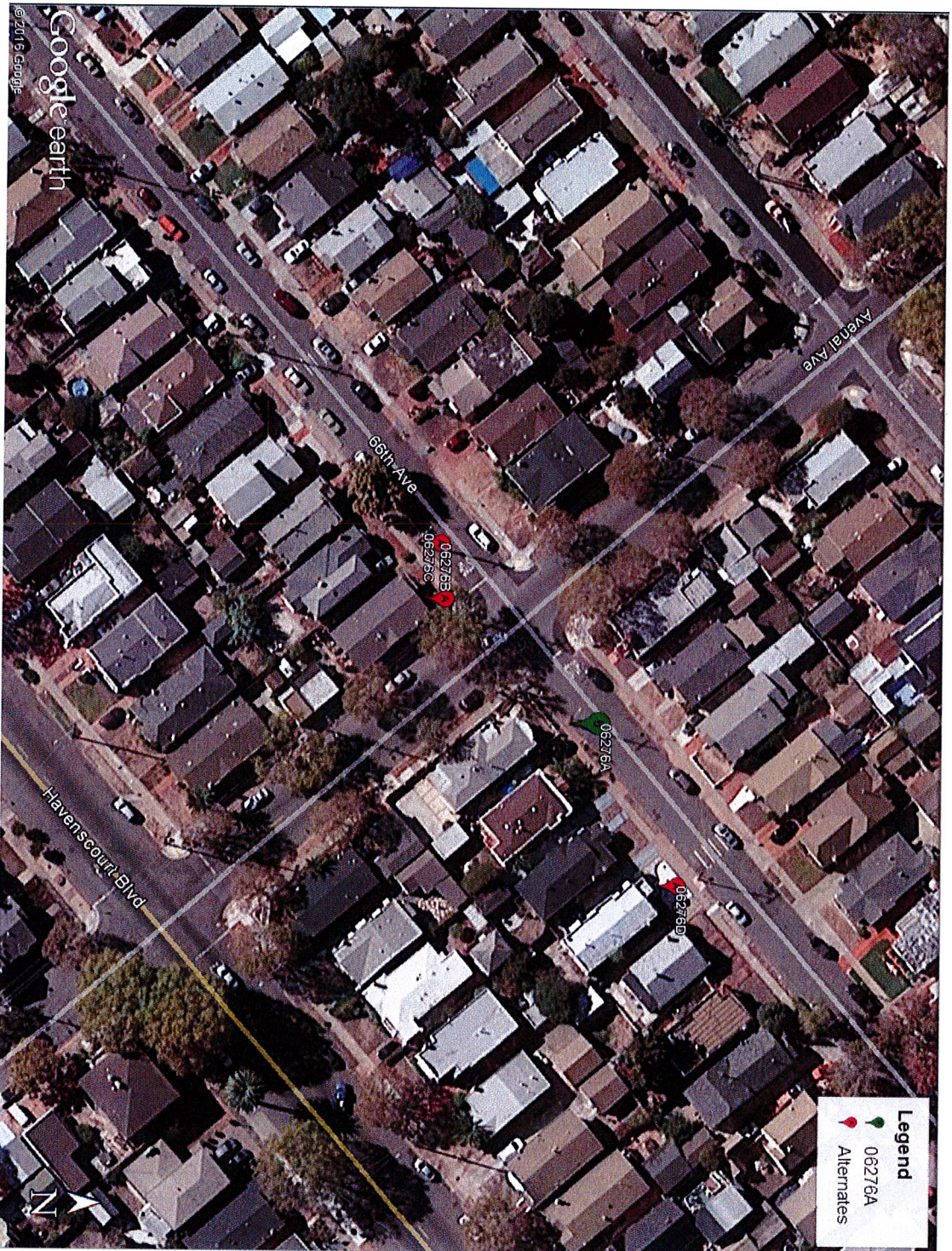

- The above maps depict Extenet's proposed Node 06276A in relation to other poles in the area that were evaluated as possibly being viable alternative candidates.
- The following is an analysis of each of those 3 alternative locations.

PROPAGATION MAP OF NODES 06276A

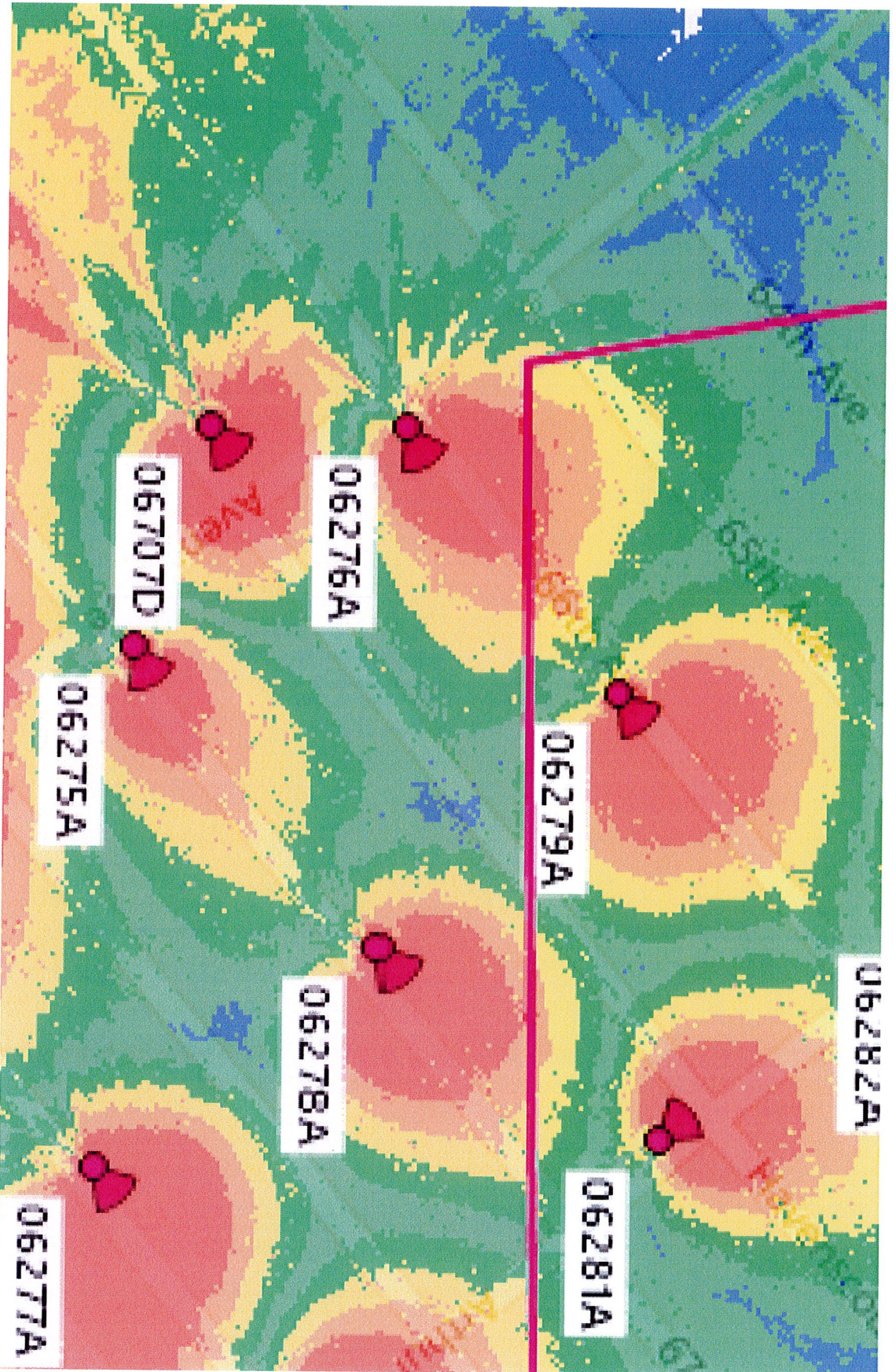

This propagation map depicts the ExteNet proposed Node 06276A in relation to surrounding proposed ExteNet small cell nodes.

06276A - PROPOSED LOCATION



- The location for ExteneNet's proposed Node 06276A is a joint utility pole located adjacent to PROW at 2400 66th Avenue (37.766457, -122.187749).
- ExteneNet's objective is to provide T-Mobile 4G wireless coverage and capacity to the Oakland area.
- ExteneNet evaluated this site and nearby alternatives to verify that the selected site is the least intrusive means to close T-Mobile's significant service coverage gap.

ALTERNATIVE NODE 06276B



- Node 06276B is a joint utility pole located in front of 2344 66th Avenue (37.766225, -122.188108).
- This pole is not a viable alternative candidate because cross lines and cross arm prevent adequate climbing space on the pole pursuant to CPUC General Order 95, thus prohibiting a wireless facility from being installed at this location.
- This pole is not a viable alternative candidate because the existing transformer on the pole would need to be relocated to an uncertain destination in order to facilitate our proposed wireless installation.
- This pole is not a viable alternative because the minimum antenna height needed at this pole would violate CPUC General Order-94 Regulation safety clearances. This configuration does not allow ExtNet the proper 2' of separation from the communication lines.
- This pole is not a viable alternative candidate because this pole is located too close to primary Node 06707D.

ALTERNATIVE NODE 06276C



- Node 06276C is a joint utility pole at 2344 66th Oakland (on Corner side) (37.766230, -122.187999).
- This pole is not a viable alternative because the signal would be blocked by trees.
- This pole is not a viable alternative candidate because this pole is located too close to primary Node 06707D.

ALTERNATIVE NODE 06276D



- Node 06276D is a joint utility pole near 2418 66th Avenue (37.766588, -122.187426).
- This pole is not a viable alternative candidate because cross lines prevent adequate climbing space on the pole pursuant to CPUC General Order 95, thus prohibiting a wireless facility from being installed at this location.
- This pole is not a viable alternative candidate because this pole is located too close to primary Node 06279A.

ALTERNATIVE SITE ANALYSIS CONCLUSION

Based on ExteneNet's analysis of alternative sites, the currently proposed Node 06276A is the least intrusive location from which to fill the surrounding significant wireless coverage gaps.

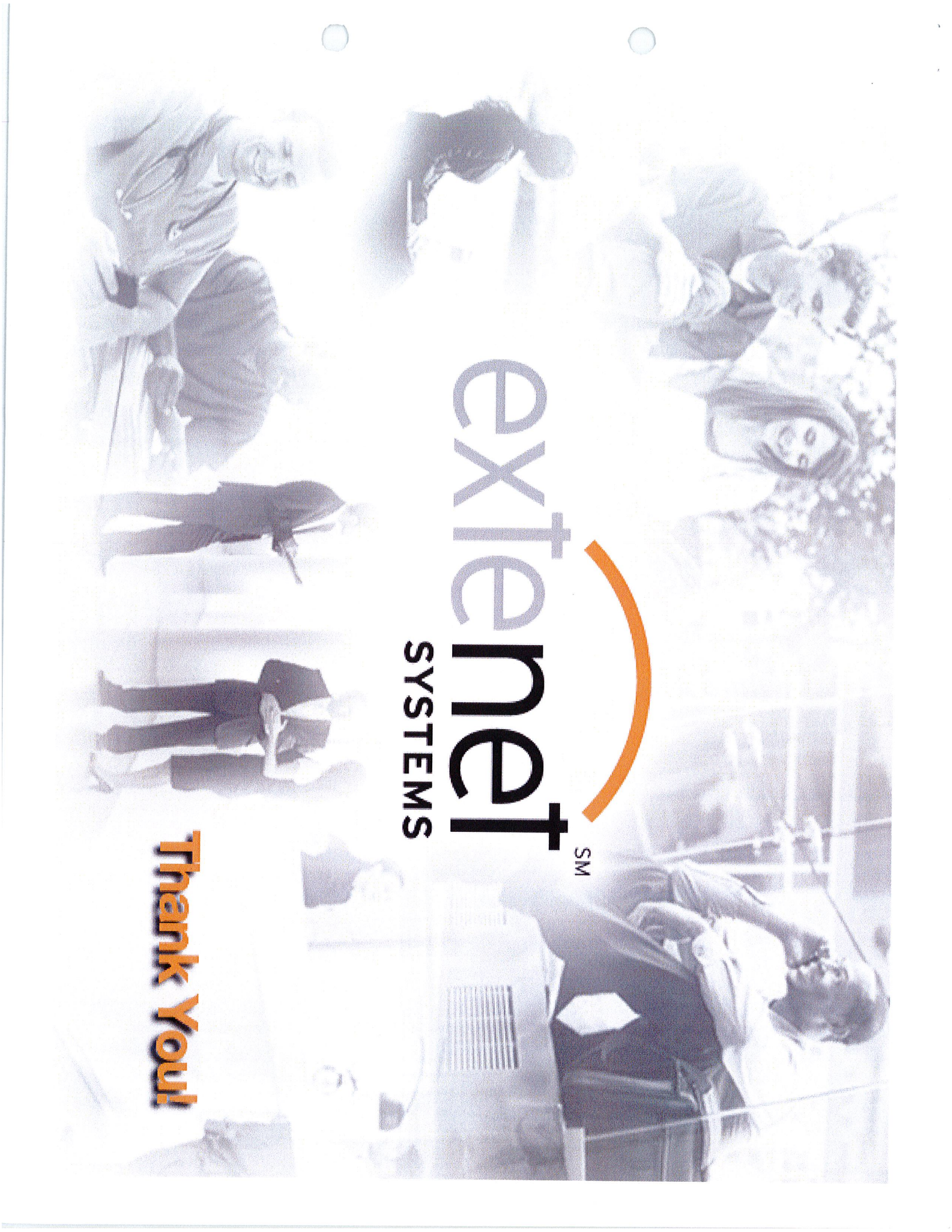

extenet



SM

SYSTEMS

Thank You!



Attachment B

October 19, 2016

City Planner
Planning Department
City of Oakland
250 Frank Ogawa Plaza, 2nd Floor
Oakland, CA 94612

Re: Proposed ExteNet Small Cell Node Installation
Applicant: ExteNet Systems (California) LLC
Nearest Site Address: Public Right of Way near 2400 66th Avenue
Site ID: NW-CA-SANFRANMC Node 06276A
Latitude/Longitude: 37.766457, -122.187749

Dear City Planner,

On behalf of ExteNet Systems (California) LLC, this letter and attached materials are to apply for a design review permit to install a small cell node in the public right-of-way near 2400 66th Avenue (“Node 06276A”).¹ The following is an explanation of the existing site, a project description of the designed facility, the project purpose and justifications in support of this proposal.

A. Project Description.

The proposed location for our facility currently consists of an approximate 38 foot 6 inch tall wood utility pole in the public right-of-way on the east side of 66th Avenue just northeast of the intersection with Avenal Avenue, at about 2400 66th Avenue. Power lines are on the pole at about 32 feet above.

ExteNet proposes to utilize existing pole measuring 38 feet 6 inches above ground and to affix one canister antenna within an antenna shroud on a proposed antenna support. The antenna, measuring 23.5 inches long and 7.9 inches in diameter, will be placed on an antenna support arm attached at 18 feet. Two proposed diplexers measuring 6.4 inches long, 4.6 inches wide and 1.8 inches deep will be placed within the side arm antenna mount. Two MRRUs measuring 7.9 inches tall, 7.9 inches wide and 3.9 inches deep will be placed on the pole at 10 feet 6 inches and 13 feet 11 inches. A miniature emergency shut-off safety switch and electricity meter will be placed on the pole at about eight feet above ground. All equipment will be painted brown to match the utility pole. Our proposal is depicted in the attached design drawings and photographic simulations.

This is an unmanned facility that will operate at all times (24 hours per day, seven days per week) and will be serviced about once per year. Our proposal will greatly benefit the area by improving wireless telecommunications service as detailed below.

B. Project Purpose.

¹ ExteNet expressly reserves all rights concerning the city’s jurisdiction to assert zoning regulation over the placement of wireless facilities in the public rights-of-way.

The purpose of this project is to provide T-Mobile third and fourth generation (3G and 4G) wireless voice and data coverage to the surrounding area where there is currently a significant gap in service coverage. These wireless services include mobile telephone, wireless broadband, emergency 911, data transfers, electronic mail, Internet, web browsing, wireless applications, wireless mapping and video streaming. The proposed node is part of a larger small cell providing coverage to areas of Oakland that are otherwise very difficult or impossible to cover using traditional macro wireless telecommunications facilities due to the local topography and mature vegetation. The attached radio frequency propagation maps depict T-Mobile's larger small cell project. Further radio frequency details are set forth in the attached Radio Frequency Statement, including propagation maps depicting existing and proposed coverage in the vicinity of Node 06276A.

A small cell network consists of a series of radio access nodes connected to small telecommunications antennas, typically mounted on existing wooden utility poles within the public rights-of-way, to distribute wireless telecommunications signals. Small cell networks provide telecommunications transmission infrastructure for use by wireless services providers. These facilities allow service providers such as T-Mobile to establish or expand their network coverage and capacity. The nodes are linked by fiber optic cable that carry the signal stemming from a central equipment hub to a node antenna. Although the signal propagated from a node antenna spans over a shorter range than a conventional tower system, small cell can be an effective tool to close service coverage gaps.

C. Project Justification, Alternative Site and Design Analysis.

Node 06276A is an integral part of the overall small cell project, and it is located in a difficult coverage area near Havenscourt Boulevard. The coverage area consists of a primarily residential neighborhood off of 66th Avenue, Avenal Avenue, 65th Avenue, Arthur Street, Havenscourt Boulevard, and surrounding areas. Node 06276A will cover transient traffic along the roadways and provide in-building service to the surrounding residences as depicted in the propagation maps, which are exhibits to the attached Radio Frequency Statement.

Based on ExteNet's analysis of alternative sites the currently proposed Node 06276A is the least intrusive means to close T-Mobile's significant service coverage gap in the area. Node 06276A best uses existing utility infrastructure, adding small equipment without disturbing the character of the neighborhoods served. Deploying a small cell node at an existing pole location minimizes any visual impact by utilizing an inconspicuous spot. By installing antennas and equipment at this existing pole location, T-Mobile does not need to propose any new infrastructure in this coverage area.

The small cell node RF emissions are also much lower than the typical macro site, they are appropriate for the area, and they are fully compliant with the FCC's requirements for limiting human exposure to radio frequency energy. The attached radio frequency engineering analysis provided by Hammett & Edison, Inc., Consulting Engineers, confirms that the proposed equipment will operate well within (and actually far below) all applicable FCC public exposure limits. The facility will also comply with California Public Utility Commission (CPUC) General Orders 95 (concerning overhead line design, construction and maintenance) and 170 (CEQA review) that govern utility use in the public right-of-way.

This proposed redesign is a viable design developed according to our discussions with the Planning Department. As discussed with City Planning, Node 06276A is the least intrusive option. Also the proposed location is a good coverage option because it sits at a spot from which point T-Mobile can adequately propagate its wireless signal.

ExteNet considered alternative sites on other utility poles in this area but none of these sites is as desirable from construction, coverage or aesthetics perspectives. The proposed location is approximately equidistant from other small cell nodes that ExteNet plans to place in surrounding hard-to-reach areas, so that service coverage can be evenly distributed. The proposed facility is not in the path of any protected view sheds. The other utility poles in the area are more conspicuous than the proposed pole. In addition to the utility pole proposed to host Node 06276A, ExteNet considered alternative sites set forth in the attached Alternative Site Analysis.

Alternative designs were considered including placing equipment inside of a ground-mounted cabinet. However, the pole-mounted equipment would better suit the area because it would blend in with the pole. We also evaluated whether equipment could be undergrounded but unfortunately this is not possible because there is insufficient right-of-way space for the necessary equipment access and the equipment would be compromised from saturation by rainwater. The antennas cannot be undergrounded because they rely on a line-of-site in order to properly transmit a signal.

Drawings, propagation maps, photographic simulations, and a radio-frequency engineering analysis are included with this packet.

As this application seeks authority to install a wireless telecommunication facility, the FCC's Shot Clock Order² requires the city to issue its final decision on ExteNet's application within 150 days. We respectfully request expedited review and approval of this application. Feel free to contact me if you have any questions. Thank you.

Thank you.

Best Regards,
EXTENET SYSTEMS

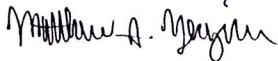

Matthew S. Yergovich

² See Petition for Declaratory Ruling to Clarify Provisions of Section 332(c)(7)(B), WT Docket No. 08-165, Declaratory Ruling, 24 F.C.C.R. 13994 (2009).



November 18, 2016

City Planner
Planning Department
City of Oakland
250 Frank H. Ogawa Plaza, 2nd Floor
Oakland, CA 94612

Re: GO 95 Required Two Feet Clearance Between Antenna and Pole
Applicant: ExteNet Systems (California) LLC
Nearest Site Address: Public Right of Way near 2400 66th Avenue
Site ID: NW-CA-SANFRNMC-TMO Node 06276A
Latitude/Longitude: 37.766457, -122.187749

Dear City Planner,

This letter is in response to discussions with City of Oakland Planning Department seeking clarification on the proposed antenna placement on the utility pole.

Wireless facility attachments to utility poles must comply with CPUC General Order 95 design, safety and clearance standards. Specifically, Rule 94.4(E) states: *Antennas shall maintain a 2 ft horizontal clearance from centerline of pole when affixed between supply and communication lines or below communication lines.* This rule precludes ExteNet from placing the antennas flush mounted to the utility pole when there is a power source attached to the pole. ExteNet minimized the clearance as much as possible by placing the antenna shroud just over two feet from the centerline of the utility pole.

Feel free to contact me if you have any questions. Thank you.

Thank you.

Best Regards,

A handwritten signature in black ink that reads "Ana Gomez/BV for ExteNet".

Ana Gomez
ExteNet Permitting Contractor

Statement of Hammett & Edison, Inc., Consulting Engineers

The firm of Hammett & Edison, Inc., Consulting Engineers, has been retained on behalf of ExteNet Systems CA, LLC, a wireless telecommunications carrier, to evaluate the addition of Node No. 06276A to be added to the ExteNet distributed antenna system (“DAS”) in Oakland, California, for compliance with appropriate guidelines limiting human exposure to radio frequency (“RF”) electromagnetic fields.

Executive Summary

ExteNet proposes to install a directional panel antenna on a utility pole sited in the public right-of-way at 2400 66th Avenue in Oakland. The proposed operation will comply with the FCC guidelines limiting public exposure to RF energy.

Prevailing Exposure Standards

The U.S. Congress requires that the Federal Communications Commission (“FCC”) evaluate its actions for possible significant impact on the environment. A summary of the FCC’s exposure limits is shown in Figure 1. These limits apply for continuous exposures and are intended to provide a prudent margin of safety for all persons, regardless of age, gender, size, or health. The most restrictive FCC limit for exposures of unlimited duration to radio frequency energy for several personal wireless services are as follows:

Wireless Service	Frequency Band	Occupational Limit	Public Limit
Microwave (Point-to-Point)	5,000–80,000 MHz	5.00 mW/cm ²	1.00 mW/cm ²
BRS (Broadband Radio)	2,600	5.00	1.00
AWS (Advanced Wireless)	2,100	5.00	1.00
PCS (Personal Communication)	1,950	5.00	1.00
Cellular	870	2.90	0.58
SMR (Specialized Mobile Radio)	855	2.85	0.57
700 MHz	700	2.35	0.47
[most restrictive frequency range]	30–300	1.00	0.20

Power line frequencies (60 Hz) are well below the applicable range of these standards, and there is considered to be no compounding effect from simultaneous exposure to power line and radio frequency fields.

General Facility Requirements

Base stations typically consist of two distinct parts: the electronic transceivers (also called “radios” or “channels”) that are connected to the traditional wired telephone lines, and the passive antennas that send the wireless signals created by the radios out to be received by individual subscriber units. The transceivers are often located at ground level and are connected to the antennas by coaxial cables.

**ExteNet Systems CA, LLC • Proposed DAS Node (Site No. 06276A)
2400 66th Avenue • Oakland, California**

A small antenna for reception of GPS signals is also required, mounted with a clear view of the sky. Because of the short wavelength of the frequencies assigned by the FCC for wireless services, the antennas require line-of-sight paths for their signals to propagate well and so are installed at some height above ground. The antennas are designed to concentrate their energy toward the horizon, with very little energy wasted toward the sky or the ground. This means that it is generally not possible for exposure conditions to approach the maximum permissible exposure limits without being physically very near the antennas.

Computer Modeling Method

The FCC provides direction for determining compliance in its Office of Engineering and Technology Bulletin No. 65, "Evaluating Compliance with FCC-Specified Guidelines for Human Exposure to Radio Frequency Radiation," dated August 1997. Figure 2 attached describes the calculation methodologies, reflecting the facts that a directional antenna's radiation pattern is not fully formed at locations very close by (the "near-field" effect) and that at greater distances the power level from an energy source decreases with the square of the distance from it (the "inverse square law"). The conservative nature of this method for evaluating exposure conditions has been verified by numerous field tests.

Site and Facility Description

Based upon information provided by ExteNet, including drawings by Black & Veatch Corporation, dated September 27, 2016, it is proposed to install one CommScope Model 3X-V65S-GC3-3XR, 2-foot tall, tri-directional cylindrical antenna, with one direction activated, on a cross-arm to be added to a utility pole sited in the public right-of-way in front of the residence located at 2400 66th Avenue in Oakland. The antenna would employ no downtilt, would be mounted at an effective height of about 20 feet above ground, and its principal direction would be oriented toward 60°T. T-Mobile proposes to operate from this facility with a maximum effective radiated power in any direction of 214 watts, representing simultaneous operation 107 watts for AWS and 107 watts for PCS service. There are reported no other wireless telecommunications base stations at this site or nearby.

Study Results

For a person anywhere at ground, the maximum RF exposure level due to the proposed T-Mobile operation is calculated to be 0.0046 mW/cm², which is 0.46% of the applicable public exposure limit. The maximum calculated level at the second-floor elevation of any nearby building is 2.0% of the public exposure limit. It should be noted that these results include several "worst-case" assumptions and therefore are expected to overstate actual power density levels from the proposed operation.

Recommended Mitigation Measures

Due to its mounting location and height, the ExteNet antenna would not be accessible to the general public, and so no mitigation measures are necessary to comply with the FCC public exposure guidelines. To prevent occupational exposures in excess of the FCC guidelines, it is recommended that appropriate RF safety training be provided to all authorized personnel who have access to the antenna, including employees and contractors of the utility companies. No access within 2 feet directly in front of the antenna itself, such as might occur during certain activities, should be allowed while the base station is in operation, unless other measures can be demonstrated to ensure that occupational protection requirements are met. Posting explanatory signs* on the pole at or below the antenna, such that the signs would be readily visible from any angle of approach to persons who might need to work within that distance, would be sufficient to meet FCC-adopted guidelines.

Conclusion

Based on the information and analysis above, it is the undersigned's professional opinion that operation of the node proposed by ExteNet Systems CA, LLC, at 2400 66th Avenue in Oakland, California, will comply with the prevailing standards for limiting public exposure to radio frequency energy and, therefore, will not for this reason cause a significant impact on the environment. The highest calculated level in publicly accessible areas is much less than the prevailing standards allow for exposures of unlimited duration. This finding is consistent with measurements of actual exposure conditions taken at other operating base stations. Training personnel and posting signs is recommended to establish compliance with occupational exposure limitations.

Authorship

The undersigned author of this statement is a qualified Professional Engineer, holding California Registration No. E-18063, which expires on June 30, 2017. This work has been carried out under his direction, and all statements are true and correct of his own knowledge except, where noted, when data has been supplied by others, which data he believes to be correct.

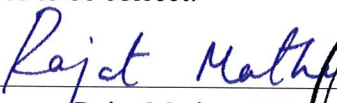
Rajat Mathur, P.E.
707/996-5200



October 10, 2016

* Signs should comply with OET-65 color, symbol, and content recommendations. Contact information should be provided (*e.g.*, a telephone number) to arrange for access to restricted areas. The selection of language(s) is not an engineering matter, and guidance from the landlord, local zoning or health authority, or appropriate professionals may be required. Signage may also need to comply with the requirements of California Public Utilities Commission General Order No. 95.



FCC Radio Frequency Protection Guide

The U.S. Congress required (1996 Telecom Act) the Federal Communications Commission (“FCC”) to adopt a nationwide human exposure standard to ensure that its licensees do not, cumulatively, have a significant impact on the environment. The FCC adopted the limits from Report No. 86, “Biological Effects and Exposure Criteria for Radiofrequency Electromagnetic Fields,” published in 1986 by the Congressionally chartered National Council on Radiation Protection and Measurements (“NCRP”). Separate limits apply for occupational and public exposure conditions, with the latter limits generally five times more restrictive. The more recent standard, developed by the Institute of Electrical and Electronics Engineers and approved as American National Standard ANSI/IEEE C95.1-2006, “Safety Levels with Respect to Human Exposure to Radio Frequency Electromagnetic Fields, 3 kHz to 300 GHz,” includes similar limits. These limits apply for continuous exposures from all sources and are intended to provide a prudent margin of safety for all persons, regardless of age, gender, size, or health.

As shown in the table and chart below, separate limits apply for occupational and public exposure conditions, with the latter limits (in *italics* and/or dashed) up to five times more restrictive:

Frequency Applicable Range (MHz)	Electromagnetic Fields (f is frequency of emission in MHz)					
	Electric Field Strength (V/m)		Magnetic Field Strength (A/m)		Equivalent Far-Field Power Density (mW/cm ²)	
0.3 – 1.34	614	<i>614</i>	1.63	<i>1.63</i>	100	<i>100</i>
1.34 – 3.0	614	<i>823.8/f</i>	1.63	<i>2.19/f</i>	100	<i>180/f²</i>
3.0 – 30	1842/f	<i>823.8/f</i>	4.89/f	<i>2.19/f</i>	900/f ²	<i>180/f²</i>
30 – 300	61.4	<i>27.5</i>	0.163	<i>0.0729</i>	1.0	<i>0.2</i>
300 – 1,500	3.54√f	<i>1.59√f</i>	√f/106	<i>√f/238</i>	f/300	<i>f/1500</i>
1,500 – 100,000	137	<i>61.4</i>	0.364	<i>0.163</i>	5.0	<i>1.0</i>

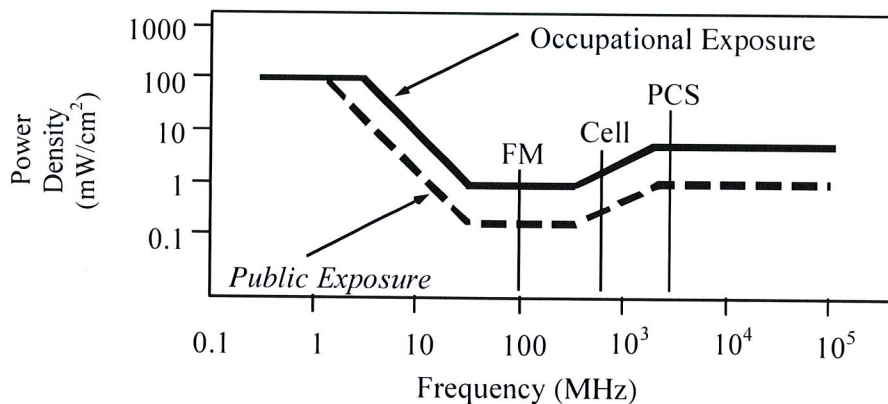

Higher levels are allowed for short periods of time, such that total exposure levels averaged over six or thirty minutes, for occupational or public settings, respectively, do not exceed the limits, and higher levels also are allowed for exposures to small areas, such that the spatially averaged levels do not exceed the limits. However, neither of these allowances is incorporated in the conservative calculation formulas in the FCC Office of Engineering and Technology Bulletin No. 65 (August 1997) for projecting field levels. Hammett & Edison has built those formulas into a proprietary program that calculates, at each location on an arbitrary rectangular grid, the total expected power density from any number of individual radio sources. The program allows for the description of buildings and uneven terrain, if required to obtain more accurate projections.



RFR.CALC™ Calculation Methodology

Assessment by Calculation of Compliance with FCC Exposure Guidelines

The U.S. Congress required (1996 Telecom Act) the Federal Communications Commission (“FCC”) to adopt a nationwide human exposure standard to ensure that its licensees do not, cumulatively, have a significant impact on the environment. The maximum permissible exposure limits adopted by the FCC (see Figure 1) apply for continuous exposures from all sources and are intended to provide a prudent margin of safety for all persons, regardless of age, gender, size, or health. Higher levels are allowed for short periods of time, such that total exposure levels averaged over six or thirty minutes, for occupational or public settings, respectively, do not exceed the limits.

Near Field.

Prediction methods have been developed for the near field zone of panel (directional) and whip (omnidirectional) antennas, typical at wireless telecommunications base stations, as well as dish (aperture) antennas, typically used for microwave links. The antenna patterns are not fully formed in the near field at these antennas, and the FCC Office of Engineering and Technology Bulletin No. 65 (August 1997) gives suitable formulas for calculating power density within such zones.

For a panel or whip antenna, power density $S = \frac{180}{\theta_{BW}} \times \frac{0.1 \times P_{net}}{\pi \times D \times h}$, in mW/cm²,

and for an aperture antenna, maximum power density $S_{max} = \frac{0.1 \times 16 \times \eta \times P_{net}}{\pi \times h^2}$, in mW/cm²,

where θ_{BW} = half-power beamwidth of the antenna, in degrees, and

P_{net} = net power input to the antenna, in watts,

D = distance from antenna, in meters,

h = aperture height of the antenna, in meters, and

η = aperture efficiency (unitless, typically 0.5-0.8).

The factor of 0.1 in the numerators converts to the desired units of power density.

Far Field.

OET-65 gives this formula for calculating power density in the far field of an individual RF source:

power density $S = \frac{2.56 \times 1.64 \times 100 \times RFF^2 \times ERP}{4 \times \pi \times D^2}$, in mW/cm²,

where ERP = total ERP (all polarizations), in kilowatts,

RFF = relative field factor at the direction to the actual point of calculation, and

D = distance from the center of radiation to the point of calculation, in meters.

The factor of 2.56 accounts for the increase in power density due to ground reflection, assuming a reflection coefficient of 1.6 (1.6 x 1.6 = 2.56). The factor of 1.64 is the gain of a half-wave dipole relative to an isotropic radiator. The factor of 100 in the numerator converts to the desired units of power density. This formula has been built into a proprietary program that calculates, at each location on an arbitrary rectangular grid, the total expected power density from any number of individual radiation sources. The program also allows for the description of uneven terrain in the vicinity, to obtain more accurate projections.

