

Location:	Utility pole in sidewalk adjacent to 1700 Seminary Avenue (see map on reverse)
Assessor's Parcel Number:	Adjacent to: 038 -3215-001-00
Proposal:	To establish a telecommunications facility, to enhance existing services, by attaching an antenna and equipment to an existing wooden utility pole located in the public right-of-way (sidewalk).
Applicant / Phone Number:	Ana Gomez/Black & Veatch & Extenet (for: T-Mobile) (913) 458-9148
Owner:	Joint Pole Authority (JPA) including PG&E
Planning Permits Required:	Regular Design Review with additional findings for Macro Telecommunications Facility
General Plan:	Mixed Housing Type Residential
Zoning:	RM-4 Mixed Housing Type Residential Zone
Environmental Determination:	Exempt, Section 15301 of the State CEQA Guidelines: Existing Facilities; Exempt, Section 15302: Replacement or Reconstruction; Exempt, Section 15303: New Construction of Small Structures; Section 15183: Projects Consistent with a Community Plan, General Plan or Zoning
Historic Status:	Non-historic property
City Council District:	6
Date Filed:	November 4, 2016
Action to be Taken:	Approve with conditions
Finality of Decision:	<i>Appealable to City Council within 10 days</i>
For Further Information:	Contact case planner Aubrey Rose, AICP at (510) 238-2071 or arose@oaklandnet.com

SUMMARY

The applicant requests Planning Commission approval of a Regular Design Review with additional findings to establish a Macro Telecommunications Facility ("small cell site"). The purpose is to enhance existing services. The project involves attaching an antenna and equipment to a wooden utility pole located on a sidewalk in the public right-of-way (sidewalk).

Staff recommends approval, subject to conditions, as described in this report.

CITY OF OAKLAND PLANNING COMMISSION

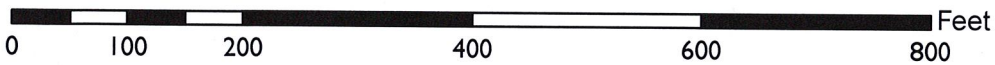

Case File: PLN16339

Applicant: Ana Gomez/Black & Veatch & Extenet (for: T-Mobile)

Address: Utility pole in sidewalk adjacent to: 1700 Seminary Avenue

Zone: RM-4

BACKGROUND

For several years in the City of Oakland, telecommunications carriers have proposed facility installation within the public right-of-way, instead of private property. These facilities typically consist of antennas and associated equipment attached to utility poles or street light poles. Poles are often replaced with replicas for technical purposes. The main purpose is to enhance existing service, given increasing technological demands for bandwidth, through new technology and locational advantages. The City exercises zoning jurisdiction over such projects in response to a 2009 State Supreme Court case decision (*Sprint v. Palos Verdes Estates*). Pursuant to the Planning Code, utility or joint pole authority (JPA) sites are classified by staff as “Macro Facilities,” and street light pole sites (lamps, not traffic signals) as “Monopole Facilities.” For JPA poles, only Design Review approval may be required, as opposed to Design Review and a Conditional Use Permit, for example. For non-JPA pole sites, such as City light poles, projects also require review by the City’s Public Works Agency (PWA) and Real Estate Division, and involve other considerations such as impacts to historical poles. The PWA may also review projects involving street lights. In either case, the practice has been to refer all such projects to the Planning Commission for decision when located in or near a residential zone.

Several projects for new DAS (distributed antenna services) facilities have come before the Planning Commission for a decision and have been installed throughout the Oakland Hills. Some applications have been denied due to view obstructions or propinquity to residences. Improved practices for the processing of all types of sites incorporating Planning Commission direction have been developed as a result. Conditions of approval typically attach requirements such as painting and texturing of approved components to more closely match utility poles in appearance. Approvals do not apply to any replacement project should the poles be removed for any reason. As with sites located on private property, the Federal Government precludes cities from denying an application on the basis of emissions concerns if a satisfactory emissions report is submitted. More recent Federal changes have streamlined the process to service existing facilities.

Currently, telecommunications carriers are in the process of attempting to deploy “small cell sites.” These projects also involve attachment of antennas and equipment at public right-of-way facilities such as poles or lights for further enhancement of services. However, components are now somewhat smaller in size than in the past. Also, sites tend to be located in flatland neighborhoods and Downtown where view obstructions are less likely to be an issue. Good design and placement is given full consideration nonetheless, especially with the greater presence of historic structures in Downtown. Additionally, given the sheer multitude of applications, and, out of consideration for Federal requirements for permit processing timelines, staff may develop alternatives to traditional staffing and agendizing.

TELECOMMUNICATIONS BACKGROUND**Limitations on Local Government Zoning Authority under the Telecommunications Act of 1996**

Section 704 of the Telecommunications Act of 1996 (TCA) provides federal standards for the siting of “Personal Wireless Services Facilities.” “Personal Wireless Services” include all commercial mobile services (including personal communications services (PCS), cellular radio mobile services, and paging); unlicensed wireless services; and common carrier wireless exchange access services. Under Section 704, local zoning authority over personal wireless services is preserved such that the FCC is prevented from preempting local land use decisions; however, local government zoning decisions are still restricted by several provisions of federal law. Specifically:

- Under Section 253 of the TCA, no state or local regulation or other legal requirement can prohibit or have the effect of prohibiting the ability of any entity to provide any interstate or intrastate telecommunications service.

- Further, Section 704 of the TCA imposes limitations on what local and state governments can do. Section 704 prohibits any state and local government action which unreasonably discriminates among personal wireless providers. Local governments must ensure that its wireless ordinance does not contain requirements in the form of regulatory terms or fees which may have the “effect” of prohibiting the placement, construction, or modification of personal wireless services.
- Section 704 also preempts any local zoning regulation purporting to regulate the placement, construction and modification of personal wireless service facilities on the basis, either directly or indirectly, on the environmental effects of radio frequency emissions (RF) of such facilities, which otherwise comply with Federal Communication Commission (FCC) standards in this regard. (See 47 U.S.C. Section 332(c)(7)(B)(iv) (1996)). This means that local authorities may not regulate the siting or construction of personal wireless facilities based on RF standards that are more stringent than those promulgated by the FCC.
- Section 704 mandates that local governments act upon personal wireless service facility siting applications to place, construct, or modify a facility within a reasonable time (See 47 U.S.C.332(c)(7)(B)(ii) and FCC Shot Clock ruling setting forth “reasonable time” standards for applications deemed complete).
- Section 704 also mandates that the FCC provide technical support to local governments in order to encourage them to make property, rights-of-way, and easements under their jurisdiction available for the placement of new spectrum-based telecommunications services. This proceeding is currently at the comment stage.

For more information on the FCC’s jurisdiction in this area, contact Steve Markendorff, Chief of the Broadband Branch, Commercial Wireless Division, Wireless Telecommunications Bureau, at (202) 418-0640 or e-mail "smarkend@fcc.gov".

SITE DESCRIPTION

The project site consists of a wooden utility pole (51’-8” in height) located in the public right-of-way (sidewalk, towards the curb) on Seminary Avenue towards the corner of East 17th Street. The pole hosts power lines on three horizontal posts (46, 50, and 51-feet above grade) and contains some graffiti a few feet above the ground. It fronts a two-story mixed use building consisting of apartments over a market (approximately 33-feet in height), separated by 9’-6” to the façade and situated toward the right-hand set of two window groups at the upper story. Between the pole and corner is a city light pole. The neighborhood consists of primarily one-story as well as two-story homes, duplexes, apartments, civic uses such as churches, and some businesses.

PROJECT DESCRIPTION

The proposal is to establish a Macro Telecommunications Facility (“small cell site”). The project would involve attaching an antenna and equipment to a 51-foot tall existing wooden utility pole. One antenna would be installed to project over the sidewalk at 18-feet in height. Various equipment would be installed projecting over the sidewalk between 10’-6” and 13’-11” in height.

GENERAL PLAN ANALYSIS

The site is located in a Mixed Housing Type Residential area under the General Plan’s Land Use and Transportation Element (LUTE). The intent of the Mixed Housing Type Residential area is: *“To create, maintain, and enhance residential areas typically located near the City’s major arterials and characterized by mix of single family homes, townhouses, small multi-unit buildings, and neighborhood businesses where appropriate.”* The proposed facility would be adjacent to an apartment’s primary

window and staff therefore recommends modifications, as described in this report. Given residential and other customers increasing reliance upon cellular service for phone and internet, the proposal for a macro telecommunications facility, as conditioned, conforms to this intent.

ZONING ANALYSIS

The site is located within the RM-4 Mixed Housing Type Residential Zone. The intent of the RM-4 Zone is: *"to create, maintain, and enhance residential areas characterized by a mix of single family homes, duplexes, townhouses, small multi-unit buildings, and neighborhood businesses where appropriate."* Macro telecommunications facilities on JPA poles require a Regular Design Review with additional findings when located in residential zones. New wireless telecommunications facilities may also be subject to a Site Alternatives Analysis, Site Design Alternatives Analysis, and a satisfactory radio-frequency (RF) emissions report. Staff analyzes the proposal in consideration of these requirements in the 'Key Issues and Impacts' section of this report. The proposed facility would be adjacent to an apartment's primary window and staff therefore recommends modifications, as described in this report. Given residential and other customers increasing reliance upon cellular service for phone and internet, the proposal for a macro telecommunications facility, as conditioned, conforms to this intent.

ENVIRONMENTAL DETERMINATION

The California Environmental Quality Act (CEQA) Guidelines categorically exempts specific types of projects from environmental review. Section 15301 exempts projects involving 'Existing Facilities;' Section 15302 exempts projects involving 'Replacement or Reconstruction;' and, Section 15303 exempts projects involving 'Construction of Small Structures.' The proposal fits all of these descriptions. The project is also subject to Section 15183 for 'Projects consistent with a community plan, general plan or zoning.' The project is therefore exempt from further Environmental Review.

KEY ISSUES AND IMPACTS

The proposal to establish a macro telecommunications facility is subject to the following Planning Code development standards, which are followed by staff's analysis in relation to this application:

17.128.070 Macro Telecommunications Facilities.

A. General Development Standards for Macro Telecommunications Facilities.

1. The Macro Facilities shall be located on existing buildings, poles or other existing support structures, or shall be post mounted.

The facility involves attachment to the an existing utility pole hosting power lines.

2. The equipment shelter or cabinet must be concealed from public view or made compatible with the architecture of the surrounding structures or placed underground. The shelter or cabinet must be regularly maintained.

Recommended conditions of approval require painting and texturing the antenna matte silver and all components matte brown, per Planning Commission direction, to match the appearance of the wooden utility pole and power line posts.

3. Macro Facilities may exceed the height limitation specified for all zones but may not exceed fifteen (15) feet above the roof line or parapet. Placement of an antenna on a nonconforming structure shall not be considered to be an expansion of the nonconforming structure.

This standard is inapplicable because the proposal does not involve attachment to a roofed structure. Nonetheless, the facility would not exceed the height of the host facility or maximum height permitted in the zoning district.

4. Ground post mounted Macro Facilities must not exceed seventeen (17) feet to the top of the antenna.

This standard is inapplicable because the proposal does not involve ground post mounting.

5. The applicant shall submit written documentation demonstrating that the emissions from the proposed project are within the limits set by the Federal Communications Commission.

This standard is met by the proposal; a satisfactory emissions report has been submitted and is attached to this report (Attachment F).

17.128.110 Site location preferences.

New wireless facilities shall generally be located on the following properties or facilities in order of preference:

- A. Co-located on an existing structure or facility with existing wireless antennas.**
- B. City-owned properties or other public or quasi-public facilities.**
- C. Existing commercial or industrial structures in Nonresidential Zones (excluding all HBX Zones and the D-CE-3 and D-CE-4 Zones).**
- D. Existing commercial or industrial structures in Residential Zones, HBX Zones, or the DCE-3 or D-CE-4 Zones.**
- E. Other Nonresidential uses in Residential Zones, HBX Zones, or the D-CE-3 or D-CE-4 Zones.**
- F. Residential uses in Nonresidential Zones (excluding all HBX Zones and the D-CE-3 and D-CE-4 Zones).**
- G. Residential uses in Residential Zones, HBX Zones, or the D-CE-3 or D-CE-4 Zones.**

Facilities locating on an A, B or C ranked preference do not require a site alternatives analysis. Facilities proposing to locate on a D through G ranked preference, inclusive, must submit a site alternatives analysis as part of the required application materials. A site alternatives analysis shall, at a minimum, consist of:

- a. The identification of all A, B and C ranked preference sites within one thousand (1,000) feet of the proposed location. If more than three (3) sites in each preference order exist, the three such closest to the proposed location shall be required.**
- b. Written evidence indicating why each such identified alternative cannot be used. Such evidence shall be in sufficient detail that independent verification, at the applicant's expense, could be obtained if required by the City of Oakland Zoning Manager. Evidence should indicate if the reason an alternative was rejected was technical (e.g. incorrect height, interference from existing RF sources, inability to cover required area) or for other concerns (e.g. refusal to lease, inability to provide utilities).**

A site alternatives analysis is not required because the proposal conforms to 'B' as it would be located on a quasi-public facility (utility pole with power lines). Nonetheless, the applicant has submitted an analysis which is attached to this report (Attachment E).

17.128.120 Site design preferences.

New wireless facilities shall generally be designed in the following order of preference:

- A. Building or structure mounted antennas completely concealed from view.**
- B. Building or structure mounted antennas set back from roof edge, not visible from public right-of way.**
- C. Building or structure mounted antennas below roof line (facade mount, pole mount) visible from public right-of-way, painted to match existing structure.**
- D. Building or structure mounted antennas above roof line visible from public right-of-way.**
- E. Monopoles.**

F. Towers.

Facilities designed to meet an A or B ranked preference do not require a site design alternatives analysis. Facilities designed to meet a C through F ranked preference, inclusive, must submit a site design alternatives analysis as part of the required application materials. A site design alternatives analysis shall, at a minimum, consist of: a. Written evidence indicating why each such higher preference design alternative cannot be used. Such evidence shall be in sufficient detail that independent verification could be obtained if required by the City of Oakland Zoning Manager. Evidence should indicate if the reason an alternative was rejected was technical (e.g. incorrect height, interference from existing RF sources, inability to cover required area) or for other concerns (e.g. inability to provide utilities, construction or structural impediments).

The proposal most closely conforms to 'D' (structured mounted antennas visible from public right-of-way), and the applicant has submitted a satisfactory site design alternatives analysis (Attachment E).

17.128.130 Radio frequency emissions standards.

The applicant for all wireless facilities, including requests for modifications to existing facilities, shall submit the following verifications:

- a. With the initial application, a RF emissions report, prepared by a licensed professional engineer or other expert, indicating that the proposed site will operate within the current acceptable thresholds as established by the Federal government or any such agency who may be subsequently authorized to establish such standards.
- b. Prior to commencement of construction, a RF emissions report indicating the baseline RF emissions condition at the proposed site.
- c. Prior to final building permit sign off, an RF emissions report indicating that the site is actually operating within the acceptable thresholds as established by the Federal government or any such agency who may be subsequently authorized to establish such standards.

A satisfactory report is attached to this report (Attachment F).

Analysis

The proposed site design would not be situated on historic pole or structure; however, it would be adjacent to a primary living space (apartment window) and could create an obstruction. Staff as therefore requested and the applicant has agreed to the following, as conditioned: the antenna is to be repositioned higher on the pole to the extent technologically possible (approximately 3-feet), and, pivoted 180-degrees to project over the street rather than the sidewalk, so that the existing pole obstructs the apartment's view of the antenna. (Please note, Photo-simulations under Attachment D are updated to reflect this modification; Plans under Attachment C are not.) Staff has also generally requested for these applications that the applicant provide a "slimmer" design consisting of tucking the antenna in closer to the pole. The applicant responded that this was not feasible due to the technological requirements by the Public Utilities Commission (Attachment G). Staff, therefore, finds the proposal, as conditioned, to provide an essential service with a less-intrusive possible design. Draft conditions of approval stipulate the relocation of the antenna position specific to this site, as well as the general requirement that the components be painted and textured to match the wooden utility pole in appearance for camouflaging, and graffiti removal.

In conclusion, staff recommends approval subject to recommended Conditions of Approval.

RECOMMENDATIONS:

1. Affirm staff's environmental determination.
2. Approve the Regular Design Review subject to the attached Findings and Conditions of Approval.

Prepared by:

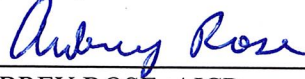

AUBREY ROSE, AICP
Planner III

Reviewed by:

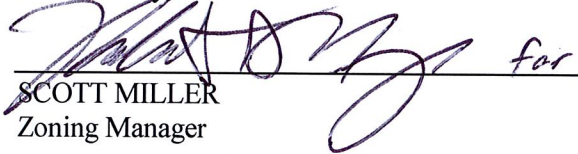

for
SCOTT MILLER
Zoning Manager

Approved for forwarding to the
City Planning Commission:

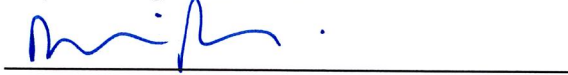

DARIN RANELLETTI, Interim Director
Planning and Building Department

ATTACHMENTS:

- A. Findings
- B. Conditions of Approval
- C. Plans (not updated)
- D. Applicant's Photo-Simulations (updated)
- E. Site Alternatives Analysis/Site Design Alternatives Analysis dated October 14, 2016
- F. RF Emissions Report by Hammett & Edison, Inc. dated October 5, 2016
- G. CPUC Compliance Letter dated October 14, 2016
- H. Applicant-proof of public notification posting

ATTACHMENT A: FINDINGS

This proposal meets the required findings under Regular Design Review Criteria for Nonresidential Facilities (OMC Sec. 17.136.050(B)) and Telecommunications Regulations/Design Review Criteria for Macro Telecommunications Facilities (OMC Sec. 17.128.070(B)), as set forth below. Required findings are shown in **bold type**; explanations as to why these findings can be made are in normal type.

REGULAR DESIGN REVIEW CRITERIA FOR NONRESIDENTIAL FACILITIES (OMC SEC. 17.136.050(B))

1. That the proposal will help achieve or maintain a group of facilities which are well related to one another and which, when taken together, will result in a well-composed design, with consideration given to site, landscape, bulk, height, arrangement, texture, materials, colors, and appurtenances; the relation of these factors to other facilities in the vicinity; and the relation of the proposal to the total setting as seen from key points in the surrounding area. Only elements of design which have some significant relationship to outside appearance shall be considered, except as otherwise provided in Section 17.136.060;

The attachment of a small antenna and equipment to a non-historic utility pole, as conditioned, will be a less intrusive design. Conditions include painting and texturizing to match the pole and power line posts in appearance for camouflaging; raising antenna height; and pivot antenna position 180-degrees to project over street rather than sidewalk. The proposal, as conditioned, would not create a view obstruction or be directly adjacent to a primary living space and will enhance essential services in an urbanized neighborhood with no ground mounting.

2. That the proposed design will be of a quality and character which harmonizes with, and serves to protect the value of, private and public investments in the area;

The attachment of a small antenna and equipment to a non-historic utility pole, as conditioned, will be a less intrusive design. Conditions include painting and texturizing to match the pole and power line posts in appearance for camouflaging; raising antenna height; and pivot antenna position 180-degrees to project over street rather than sidewalk. The proposal, as conditioned, would not create a view obstruction or be directly adjacent to a primary living space and will enhance essential services in an urbanized neighborhood with no ground mounting.

3. That the proposed design conforms in all significant respects with the Oakland General Plan and with any applicable design review guidelines or criteria, district plan, or development control map which have been adopted by the Planning Commission or City Council.

The site is located in a Detached Unit Residential area under the General Plan's Land Use and Transportation Element (LUTE). The intent of the Hillside Residential area is: *"To create, maintain, and enhance residential areas characterized by detached, single unit structures."* Given residential customers' increasing reliance upon cellular service for phone and wi-fi, the proposal for a macro telecommunications facility, as conditioned, conforms to this intent.

TELECOMMUNICATIONS REGULATIONS/DESIGN REVIEW CRITERIA FOR MACRO TELECOMMUNICATIONS FACILITIES (OMC SEC. 17.128.070(B))

1. Antennas should be painted and/or textured to match the existing structure.

The antenna will be painted and textured matte silver to match the power line posts in appearance for camouflaging, will be the least intrusive design, as required by conditions of approval.

2. Antennas mounted on architecturally significant structures or significant architectural detail of the building should be covered by appropriate casings which are manufactured to match existing architectural features found on the building.

This finding is inapplicable because the antenna will not be mounted onto an architecturally significant structure but to an existing wooden utility pole.

3. Where feasible, antennas can be placed directly above, below or incorporated with vertical design elements of a building to help in camouflaging.

The antenna will be positioned facing the building and below posts hosting power lines.

4. Equipment shelters or cabinets shall be screened from the public view by using landscaping, or materials and colors consistent with surrounding backdrop or placed underground or inside existing facilities or behind screening fences.

Conditions of approval require painting and texturing matte brown to match the pole in appearance for camouflaging.

5. Equipment shelters or cabinets shall be consistent with the general character of the area.

Equipment will be attached to the utility pole with an unobtrusive design.

6. For antennas attached to the roof, maintain a 1:1 ratio (example: ten (10) feet high antenna requires ten (10) feet setback from facade) for equipment setback; screen the antennas to match existing air conditioning units, stairs, or elevator towers; avoid placing roof mounted antennas in direct line with significant view corridors.

This finding is inapplicable because the antenna would be attached to a pole and not to a roofed structure.

7. That all reasonable means of reducing public access to the antennas and equipment has been made, including, but not limited to, placement in or on buildings or structures, fencing, anti-climbing measures and anti-tampering devices.

The minimal clearance to the facility will be 7'-4".

Attachment B: Conditions of Approval

1. Approved Use

The project shall be constructed and operated in accordance with the authorized use as described in the approved application materials, **staff report** and the approved plans **dated September 22, 2016 and submitted November 4, 2016**, as amended by the following conditions of approval and mitigation measures, if applicable (“Conditions of Approval” or “Conditions”).

2. Effective Date, Expiration, Extensions and Extinguishment

This Approval shall become effective immediately, unless the Approval is appealable, in which case the Approval shall become effective in ten calendar days unless an appeal is filed. Unless a different termination date is prescribed, this Approval shall expire **two calendar years** from the Approval date, or from the date of the final decision in the event of an appeal, unless within such period all necessary permits for construction or alteration have been issued, or the authorized activities have commenced in the case of a permit not involving construction or alteration. Upon written request and payment of appropriate fees submitted no later than the expiration date of this Approval, the Director of City Planning or designee may grant a one-year extension of this date, with additional extensions subject to approval by the approving body. Expiration of any necessary building permit or other construction-related permit for this project may invalidate this Approval if said Approval has also expired. If litigation is filed challenging this Approval, or its implementation, then the time period stated above for obtaining necessary permits for construction or alteration and/or commencement of authorized activities is automatically extended for the duration of the litigation.

3. Compliance with Other Requirements

The project applicant shall comply with all other applicable federal, state, regional, and local laws/codes, requirements, regulations, and guidelines, including but not limited to those imposed by the City’s Bureau of Building, Fire Marshal, and Public Works Department. Compliance with other applicable requirements may require changes to the approved use and/or plans. These changes shall be processed in accordance with the procedures contained in Condition #4.

4. Minor and Major Changes

- a. Minor changes to the approved project, plans, Conditions, facilities, or use may be approved administratively by the Director of City Planning.
- b. Major changes to the approved project, plans, Conditions, facilities, or use shall be reviewed by the Director of City Planning to determine whether such changes require submittal and approval of a revision to the Approval by the original approving body or a new independent permit/approval. Major revisions shall be reviewed in accordance with the procedures required for the original permit/approval. A new independent permit/approval shall be reviewed in accordance with the procedures required for the new permit/approval.

5. Compliance with Conditions of Approval

- a. The project applicant and property owner, including successors, (collectively referred to hereafter as the “project applicant” or “applicant”) shall be responsible for compliance with all the Conditions of Approval and any recommendations contained in any submitted and approved technical report at his/her sole cost and expense, subject to review and approval by the City of Oakland.
- b. The City of Oakland reserves the right at any time during construction to require certification by a licensed professional at the project applicant’s expense that the as-built project

conforms to all applicable requirements, including but not limited to, approved maximum heights and minimum setbacks. Failure to construct the project in accordance with the Approval may result in remedial reconstruction, permit revocation, permit modification, stop work, permit suspension, or other corrective action.

- c. Violation of any term, Condition, or project description relating to the Approval is unlawful, prohibited, and a violation of the Oakland Municipal Code. The City of Oakland reserves the right to initiate civil and/or criminal enforcement and/or abatement proceedings, or after notice and public hearing, to revoke the Approval or alter these Conditions if it is found that there is violation of any of the Conditions or the provisions of the Planning Code or Municipal Code, or the project operates as or causes a public nuisance. This provision is not intended to, nor does it, limit in any manner whatsoever the ability of the City to take appropriate enforcement actions. The project applicant shall be responsible for paying fees in accordance with the City's Master Fee Schedule for inspections conducted by the City or a City-designated third-party to investigate alleged violations of the Approval or Conditions.

6. Signed Copy of the Approval/Conditions

A copy of the Approval letter and Conditions shall be signed by the project applicant, attached to each set of permit plans submitted to the appropriate City agency for the project, and made available for review at the project job site at all times.

7. Blight/Nuisances

The project site shall be kept in a blight/nuisance-free condition. Any existing blight or nuisance shall be abated within 60 days of approval, unless an earlier date is specified elsewhere.

8. Indemnification

- a. To the maximum extent permitted by law, the project applicant shall defend (with counsel acceptable to the City), indemnify, and hold harmless the City of Oakland, the Oakland City Council, the Oakland Redevelopment Successor Agency, the Oakland City Planning Commission, and their respective agents, officers, employees, and volunteers (hereafter collectively called "City") from any liability, damages, claim, judgment, loss (direct or indirect), action, causes of action, or proceeding (including legal costs, attorneys' fees, expert witness or consultant fees, City Attorney or staff time, expenses or costs) (collectively called "Action") against the City to attack, set aside, void or annul this Approval or implementation of this Approval. The City may elect, in its sole discretion, to participate in the defense of said Action and the project applicant shall reimburse the City for its reasonable legal costs and attorneys' fees.
- b. Within ten (10) calendar days of the filing of any Action as specified in subsection (a) above, the project applicant shall execute a Joint Defense Letter of Agreement with the City, acceptable to the Office of the City Attorney, which memorializes the above obligations. These obligations and the Joint Defense Letter of Agreement shall survive termination, extinguishment, or invalidation of the Approval. Failure to timely execute the Letter of Agreement does not relieve the project applicant of any of the obligations contained in this Condition or other requirements or Conditions of Approval that may be imposed by the City.

9. Severability

The Approval would not have been granted but for the applicability and validity of each and every one of the specified Conditions, and if one or more of such Conditions is found to be invalid by a

court of competent jurisdiction this Approval would not have been granted without requiring other valid Conditions consistent with achieving the same purpose and intent of such Approval.

10. Special Inspector/Inspections, Independent Technical Review, Project Coordination and Monitoring

The project applicant may be required to cover the full costs of independent third-party technical review and City monitoring and inspection, including without limitation, special inspector(s)/inspection(s) during times of extensive or specialized plan-check review or construction, and inspections of potential violations of the Conditions of Approval. The project applicant shall establish a deposit with the Bureau of Building, if directed by the Building Official, Director of City Planning, or designee, prior to the issuance of a construction-related permit and on an ongoing as-needed basis.

11. Public Improvements

The project applicant shall obtain all necessary permits/approvals, such as encroachment permits, obstruction permits, curb/gutter/sidewalk permits, and public improvement (“p-job”) permits from the City for work in the public right-of-way, including but not limited to, streets, curbs, gutters, sidewalks, utilities, and fire hydrants. Prior to any work in the public right-of-way, the applicant shall submit plans for review and approval by the Bureau of Planning, the Bureau of Building, and other City departments as required. Public improvements shall be designed and installed to the satisfaction of the City.

12. Regulatory Permits and Authorizations from Other Agencies

Requirement: The project applicant shall obtain all necessary regulatory permits and authorizations from applicable resource/regulatory agencies including, but not limited to, the Regional Water Quality Control Board, Bay Area Air Quality Management District, Bay Conservation and Development Commission, California Department of Fish and Wildlife, U. S. Fish and Wildlife Service, and Army Corps of Engineers and shall comply with all requirements and conditions of the permits/authorizations. The project applicant shall submit evidence of the approved permits/authorizations to the City, along with evidence demonstrating compliance with any regulatory permit/authorization conditions of approval.

When Required: Prior to activity requiring permit/authorization from regulatory agency

Initial Approval: Approval by applicable regulatory agency with jurisdiction; evidence of approval submitted to Bureau of Planning

Monitoring/Inspection: Applicable regulatory agency with jurisdiction

13. Graffiti Control

Requirement:

- a. During construction and operation of the project, the project applicant shall incorporate best management practices reasonably related to the control of graffiti and/or the mitigation of the impacts of graffiti. Such best management practices may include, without limitation:

Installation and maintenance of landscaping to discourage defacement of and/or protect likely graffiti-attracting surfaces.

Installation and maintenance of lighting to protect likely graffiti-attracting surfaces.

Use of paint with anti-graffiti coating.

Incorporation of architectural or design elements or features to discourage graffiti defacement in accordance with the principles of Crime Prevention Through Environmental Design (CPTED).

Other practices approved by the City to deter, protect, or reduce the potential for graffiti defacement.

- b. The project applicant shall remove graffiti by appropriate means within seventy-two (72) hours. Appropriate means include the following:
 - i. Removal through scrubbing, washing, sanding, and/or scraping (or similar method) without damaging the surface and without discharging wash water or cleaning detergents into the City storm drain system.
 - ii. Covering with new paint to match the color of the surrounding surface.
 - iii. Replacing with new surfacing (with City permits if required).

When Required: Ongoing

Initial Approval: N/A

Monitoring/Inspection: Bureau of Building

14. Construction-Related Air Pollution Controls (Dust and Equipment Emissions)

Requirement: The project applicant shall implement all of the following applicable air pollution control measures during construction of the project:

- a. Water all exposed surfaces of active construction areas at least twice daily. Watering should be sufficient to prevent airborne dust from leaving the site. Increased watering frequency may be necessary whenever wind speeds exceed 15 miles per hour. Reclaimed water should be used whenever feasible.
- b. Cover all trucks hauling soil, sand, and other loose materials or require all trucks to maintain at least two feet of freeboard (i.e., the minimum required space between the top of the load and the top of the trailer).
- c. All visible mud or dirt track-out onto adjacent public roads shall be removed using wet power vacuum street sweepers at least once per day. The use of dry power sweeping is prohibited.
- d. Pave all roadways, driveways, sidewalks, etc. within one month of site grading or as soon as feasible. In addition, building pads should be laid within one month of grading or as soon as feasible unless seeding or soil binders are used.
- e. Enclose, cover, water twice daily, or apply (non-toxic) soil stabilizers to exposed stockpiles (dirt, sand, etc.).
- f. Limit vehicle speeds on unpaved roads to 15 miles per hour.
- g. Idling times on all diesel-fueled commercial vehicles over 10,000 lbs. shall be minimized either by shutting equipment off when not in use or reducing the maximum idling time to five minutes (as required by the California airborne toxics control measure Title 13, Section 2485, of the California Code of Regulations). Clear signage to this effect shall be provided for construction workers at all access points.
- h. Idling times on all diesel-fueled off-road vehicles over 25 horsepower shall be minimized either by shutting equipment off when not in use or reducing the maximum idling time to five minutes and fleet operators must develop a written policy as required by Title 23, Section 2449, of the California Code of Regulations ("California Air Resources Board Off-Road Diesel Regulations").
- i. All construction equipment shall be maintained and properly tuned in accordance with the manufacturer's specifications. All equipment shall be checked by a certified mechanic and determined to be running in proper condition prior to operation.

- j. Portable equipment shall be powered by electricity if available. If electricity is not available, propane or natural gas shall be used if feasible. Diesel engines shall only be used if electricity is not available and it is not feasible to use propane or natural gas.

15. Archaeological and Paleontological Resources – Discovery During Construction

Requirement: Pursuant to CEQA Guidelines section 15064.5(f), in the event that any historic or prehistoric subsurface cultural resources are discovered during ground disturbing activities, all work within 50 feet of the resources shall be halted and the project applicant shall notify the City and consult with a qualified archaeologist or paleontologist, as applicable, to assess the significance of the find. In the case of discovery of paleontological resources, the assessment shall be done in accordance with the Society of Vertebrate Paleontology standards. If any find is determined to be significant, appropriate avoidance measures recommended by the consultant and approved by the City must be followed unless avoidance is determined unnecessary or infeasible by the City. Feasibility of avoidance shall be determined with consideration of factors such as the nature of the find, project design, costs, and other considerations. If avoidance is unnecessary or infeasible, other appropriate measures (e.g., data recovery, excavation) shall be instituted. Work may proceed on other parts of the project site while measures for the cultural resources are implemented.

In the event of data recovery of archaeological resources, the project applicant shall submit an Archaeological Research Design and Treatment Plan (ARDTP) prepared by a qualified archaeologist for review and approval by the City. The ARDTP is required to identify how the proposed data recovery program would preserve the significant information the archaeological resource is expected to contain. The ARDTP shall identify the scientific/historic research questions applicable to the expected resource, the data classes the resource is expected to possess, and how the expected data classes would address the applicable research questions. The ARDTP shall include the analysis and specify the curation and storage methods. Data recovery, in general, shall be limited to the portions of the archaeological resource that could be impacted by the proposed project. Destructive data recovery methods shall not be applied to portions of the archaeological resources if nondestructive methods are practicable. Because the intent of the ARDTP is to save as much of the archaeological resource as possible, including moving the resource, if feasible, preparation and implementation of the ARDTP would reduce the potential adverse impact to less than significant. The project applicant shall implement the ARDTP at his/her expense.

In the event of excavation of paleontological resources, the project applicant shall submit an excavation plan prepared by a qualified paleontologist to the City for review and approval. All significant cultural materials recovered shall be subject to scientific analysis, professional museum curation, and/or a report prepared by a qualified paleontologist, as appropriate, according to current professional standards and at the expense of the project applicant.

When Required: During construction

Initial Approval: N/A

Monitoring/Inspection: Bureau of Building

16. Human Remains – Discovery During Construction

Requirement: Pursuant to CEQA Guidelines section 15064.5(e)(1), in the event that human skeletal remains are uncovered at the project site during construction activities, all work shall immediately halt and the project applicant shall notify the City and the Alameda County Coroner. If the County Coroner determines that an investigation of the cause of death is required or that the remains are Native American, all work shall cease within 50 feet of the remains until appropriate arrangements are made. In the event that the remains are Native American, the City shall contact the California Native American Heritage Commission (NAHC), pursuant to subdivision (c) of section 7050.5 of

the California Health and Safety Code. If the agencies determine that avoidance is not feasible, then an alternative plan shall be prepared with specific steps and timeframe required to resume construction activities. Monitoring, data recovery, determination of significance, and avoidance measures (if applicable) shall be completed expeditiously and at the expense of the project applicant.

When Required: During construction

Initial Approval: N/A

Monitoring/Inspection: Bureau of Building

17. Construction-Related Permit(s)

Requirement: The project applicant shall obtain all required construction-related permits/approvals from the City. The project shall comply with all standards, requirements and conditions contained in construction-related codes, including but not limited to the Oakland Building Code and the Oakland Grading Regulations, to ensure structural integrity and safe construction.

When Required: Prior to approval of construction-related permit

Initial Approval: Bureau of Building

Monitoring/Inspection: Bureau of Building

18. Hazardous Materials Related to Construction

Requirement: The project applicant shall ensure that Best Management Practices (BMPs) are implemented by the contractor during construction to minimize potential negative effects on groundwater, soils, and human health. These shall include, at a minimum, the following:

- a. Follow manufacture's recommendations for use, storage, and disposal of chemical products used in construction;
- b. Avoid overtopping construction equipment fuel gas tanks;
- c. During routine maintenance of construction equipment, properly contain and remove grease and oils;
- d. Properly dispose of discarded containers of fuels and other chemicals;
- e. Implement lead-safe work practices and comply with all local, regional, state, and federal requirements concerning lead (for more information refer to the Alameda County Lead Poisoning Prevention Program); and
- f. If soil, groundwater, or other environmental medium with suspected contamination is encountered unexpectedly during construction activities (e.g., identified by odor or visual staining, or if any underground storage tanks, abandoned drums or other hazardous materials or wastes are encountered), the project applicant shall cease work in the vicinity of the suspect material, the area shall be secured as necessary, and the applicant shall take all appropriate measures to protect human health and the environment. Appropriate measures shall include notifying the City and applicable regulatory agency(ies) and implementation of the actions described in the City's Standard Conditions of Approval, as necessary, to identify the nature and extent of contamination. Work shall not resume in the area(s) affected until the measures have been implemented under the oversight of the City or regulatory agency, as appropriate.

When Required: During construction

Initial Approval: N/A

Monitoring/Inspection: Bureau of Building

19. Construction Days/Hours

Requirement: The project applicant shall comply with the following restrictions concerning construction days and hours:

- a. Construction activities are limited to between 7:00 a.m. and 7:00 p.m. Monday through Friday, except that pier drilling and/or other extreme noise generating activities greater than 90 dBA shall be limited to between 8:00 a.m. and 4:00 p.m.
- b. Construction activities are limited to between 9:00 a.m. and 5:00 p.m. on Saturday. In residential zones and within 300 feet of a residential zone, construction activities are allowed from 9:00 a.m. to 5:00 p.m. only within the interior of the building with the doors and windows closed. No pier drilling or other extreme noise generating activities greater than 90 dBA are allowed on Saturday.
- c. No construction is allowed on Sunday or federal holidays.

Construction activities include, but are not limited to, truck idling, moving equipment (including trucks, elevators, etc.) or materials, deliveries, and construction meetings held on-site in a non-enclosed area.

Any construction activity proposed outside of the above days and hours for special activities (such as concrete pouring which may require more continuous amounts of time) shall be evaluated on a case-by-case basis by the City, with criteria including the urgency/emergency nature of the work, the proximity of residential or other sensitive uses, and a consideration of nearby residents'/occupants' preferences. The project applicant shall notify property owners and occupants located within 300 feet at least 14 calendar days prior to construction activity proposed outside of the above days/hours. When submitting a request to the City to allow construction activity outside of the above days/hours, the project applicant shall submit information concerning the type and duration of proposed construction activity and the draft public notice for City review and approval prior to distribution of the public notice.

When Required: During construction

Initial Approval: N/A

Monitoring/Inspection: Bureau of Building

20. Construction Noise

Requirement: The project applicant shall implement noise reduction measures to reduce noise impacts due to construction. Noise reduction measures include, but are not limited to, the following:

- a. Equipment and trucks used for project construction shall utilize the best available noise control techniques (e.g., improved mufflers, equipment redesign, use of intake silencers, ducts, engine enclosures and acoustically-attenuating shields or shrouds) wherever feasible.
- b. Except as provided herein, impact tools (e.g., jack hammers, pavement breakers, and rock drills) used for project construction shall be hydraulically or electrically powered to avoid noise associated with compressed air exhaust from pneumatically powered tools. However, where use of pneumatic tools is unavoidable, an exhaust muffler on the compressed air exhaust shall be used; this muffler can lower noise levels from the exhaust by up to about 10 dBA. External jackets on the tools themselves shall be used, if such jackets are commercially available, and this could achieve a reduction of 5 dBA. Quieter procedures shall be used, such as drills rather than impact equipment, whenever such procedures are available and consistent with construction procedures.
- c. Applicant shall use temporary power poles instead of generators where feasible.

- d. Stationary noise sources shall be located as far from adjacent properties as possible, and they shall be muffled and enclosed within temporary sheds, incorporate insulation barriers, or use other measures as determined by the City to provide equivalent noise reduction.
- e. The noisiest phases of construction shall be limited to less than 10 days at a time. Exceptions may be allowed if the City determines an extension is necessary and all available noise reduction controls are implemented.

When Required: During construction

Initial Approval: N/A

Monitoring/Inspection: Bureau of Building

21. Extreme Construction Noise

a. **Construction Noise Management Plan Required**

Requirement: Prior to any extreme noise generating construction activities (e.g., pier drilling, pile driving and other activities generating greater than 90dBA), the project applicant shall submit a Construction Noise Management Plan prepared by a qualified acoustical consultant for City review and approval that contains a set of site-specific noise attenuation measures to further reduce construction impacts associated with extreme noise generating activities. The project applicant shall implement the approved Plan during construction. Potential attenuation measures include, but are not limited to, the following:

- i. Erect temporary plywood noise barriers around the construction site, particularly along on sites adjacent to residential buildings;
- ii. Implement “quiet” pile driving technology (such as pre-drilling of piles, the use of more than one pile driver to shorten the total pile driving duration), where feasible, in consideration of geotechnical and structural requirements and conditions;
- iii. Utilize noise control blankets on the building structure as the building is erected to reduce noise emission from the site;
- iv. Evaluate the feasibility of noise control at the receivers by temporarily improving the noise reduction capability of adjacent buildings by the use of sound blankets for example and implement such measure if such measures are feasible and would noticeably reduce noise impacts; and
- v. Monitor the effectiveness of noise attenuation measures by taking noise measurements.

When Required: Prior to approval of construction-related permit

Initial Approval: Bureau of Building

Monitoring/Inspection: Bureau of Building

b. **Public Notification Required**

Requirement: The project applicant shall notify property owners and occupants located within 300 feet of the construction activities at least 14 calendar days prior to commencing extreme noise generating activities. Prior to providing the notice, the project applicant shall submit to the City for review and approval the proposed type and duration of extreme noise generating activities and the proposed public notice. The public notice shall provide the estimated start and end dates of the extreme noise generating activities and describe noise attenuation measures to be implemented.

When Required: During construction

Initial Approval: Bureau of Building

Monitoring/Inspection: Bureau of Building

22. Operational Noise

Requirement: Noise levels from the project site after completion of the project (i.e., during project operation) shall comply with the performance standards of chapter 17.120 of the Oakland Planning Code and chapter 8.18 of the Oakland Municipal Code. If noise levels exceed these standards, the activity causing the noise shall be abated until appropriate noise reduction measures have been installed and compliance verified by the City.

When Required: Ongoing

Initial Approval: N/A

Monitoring/Inspection: Bureau of Building

23. Construction Activity in the Public Right-of-Way**a. Obstruction Permit Required**

Requirement: The project applicant shall obtain an obstruction permit from the City prior to placing any temporary construction-related obstruction in the public right-of-way, including City streets and sidewalks.

When Required: Prior to approval of construction-related permit

Initial Approval: Bureau of Building

Monitoring/Inspection: Bureau of Building

b. Traffic Control Plan Required

Requirement: In the event of obstructions to vehicle or bicycle travel lanes, the project applicant shall submit a Traffic Control Plan to the City for review and approval prior to obtaining an obstruction permit. The project applicant shall submit evidence of City approval of the Traffic Control Plan with the application for an obstruction permit. The Traffic Control Plan shall contain a set of comprehensive traffic control measures for auto, transit, bicycle, and pedestrian detours, including detour signs if required, lane closure procedures, signs, cones for drivers, and designated construction access routes. The project applicant shall implement the approved Plan during construction.

When Required: Prior to approval of construction-related permit

Initial Approval: Public Works Department, Transportation Services Division

Monitoring/Inspection: Bureau of Building

c. Repair of City Streets

Requirement: The project applicant shall repair any damage to the public right-of way, including streets and sidewalks caused by project construction at his/her expense within one week of the occurrence of the damage (or excessive wear), unless further damage/excessive wear may continue; in such case, repair shall occur prior to approval of the final inspection of the construction-related permit. All damage that is a threat to public health or safety shall be repaired immediately.

When Required: Prior to building permit final

Initial Approval: N/A

Monitoring/Inspection: Bureau of Building

24. Construction and Demolition Waste Reduction and Recycling

Requirement: The project applicant shall comply with the City of Oakland Construction and Demolition Waste Reduction and Recycling Ordinance (chapter 15.34 of the Oakland Municipal Code) by submitting a Construction and Demolition Waste Reduction and Recycling Plan (WRRP) for City review and approval, and shall implement the approved WRRP. Projects subject to these

requirements include all new construction, renovations/alterations/modifications with construction values of \$50,000 or more (except R-3 type construction), and all demolition (including soft demolition) except demolition of type R-3 construction. The WRRP must specify the methods by which the project will divert construction and demolition debris waste from landfill disposal in accordance with current City requirements. The WRRP may be submitted electronically at www.greenhalosystems.com or manually at the City's Green Building Resource Center. Current standards, FAQs, and forms are available on the City's website and in the Green Building Resource Center.

When Required: Prior to approval of construction-related permit

Initial Approval: Public Works Department, Environmental Services Division

Monitoring/Inspection: Public Works Department, Environmental Services Division

25. Underground Utilities

Requirement: The project applicant shall place underground all new utilities serving the project and under the control of the project applicant and the City, including all new gas, electric, cable, and telephone facilities, fire alarm conduits, street light wiring, and other wiring, conduits, and similar facilities. The new facilities shall be placed underground along the project's street frontage and from the project structures to the point of service. Utilities under the control of other agencies, such as PG&E, shall be placed underground if feasible. All utilities shall be installed in accordance with standard specifications of the serving utilities.

When Required: During construction

Initial Approval: N/A

Monitoring/Inspection: Bureau of Building

PROJECT-SPECIFIC CONDITIONS

26. Public Works Review

Requirement: The plans shall receive a satisfactory review from the Public Works Agency, incorporating any required modifications.

When Required: Prior to submitting a building permit application

Initial Approval: N/A

Monitoring/Inspection: N/A

27. Emissions Report

Requirement: A RF emissions report shall be submitted to the Planning Bureau indicating that the site is actually operating within the acceptable thresholds as established by the Federal government or any such agency who may be subsequently authorized to establish such standards.

Requirement: Prior to a final inspection

When Required: Prior to submitting a building permit application

Initial Approval: N/A

Monitoring/Inspection: N/A

28. Camouflage

Requirement: The antenna shall be painted, texturized, and maintained matte silver, and the equipment and any other accessory items including cables matte brown, to better camouflage the facility to the utility pole and attached power line posts.

When Required: Prior to a final inspection

Initial Approval: N/A

Monitoring/Inspection: Bureau of Building

29. Operational

Requirement: Noise levels from the activity, property, or any mechanical equipment on site shall comply with the performance standards of Section 17.120 of the Oakland Planning Code and Section 8.18 of the Oakland Municipal Code. If noise levels exceed these standards, the activity causing the noise shall be abated until appropriate noise reduction measures have been installed and compliance verified by the Planning and Zoning Division and Building Services.

When Required: Ongoing

Initial Approval: N/A

Monitoring/Inspection: Bureau of Building

30. Possible District Undergrounding PG&E Pole

Requirement: Should the PG &E utility pole be permanently removed for purposes of district undergrounding or otherwise, the telecommunications facility can only be re-established by applying for and receiving approval of a new application to the Oakland Planning Bureau as required by the regulations.

When Required: Ongoing

Initial Approval: N/A

Monitoring/Inspection: N/A

31. Antenna Repositioning

Requirement: Plans shall be modified prior to submitting for a Building Permit to depict the antenna shall be located higher to the extent technologically possible (approximately 3-feet), and, pivoted 180-degrees to project over the street rather than the sidewalk.

When Required: Prior to a submitting for a building permit & final inspection

Initial Approval: Bureau of Planning

Monitoring/Inspection: Bureau of Building

NW-CA-SANFRNMC 06089B

ADJACENT TO (IN PROX)
1700 SEMINARY AVENUE
OAKLAND, CA 94621

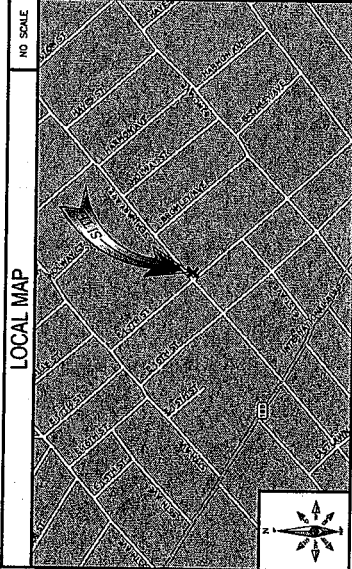

LOCAL MAP

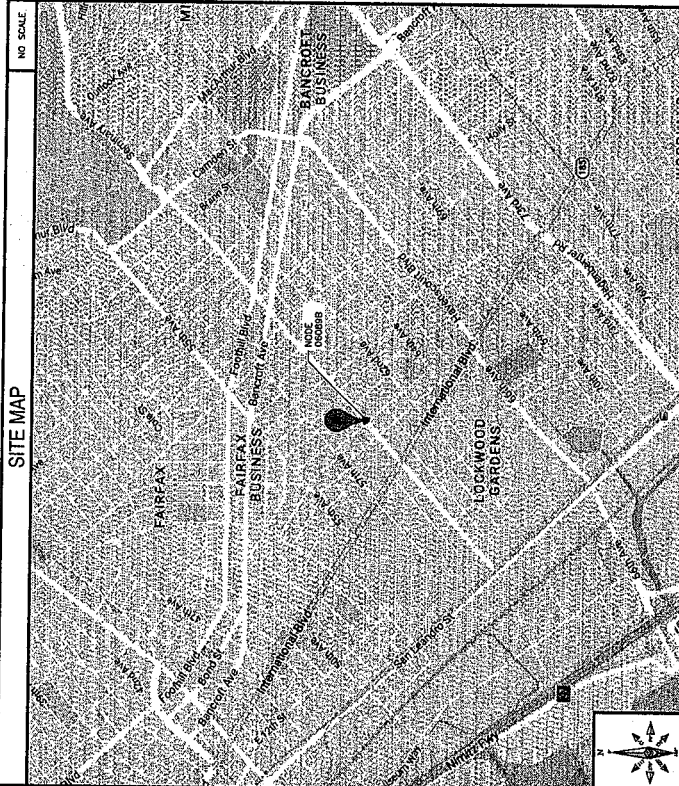

SITE MAP

CODE COMPLIANCE

ALL WORK AND MATERIALS SHALL BE RECORDED AND INSTALLED IN ACCORDANCE WITH THE CURRENT EDITIONS OF THE FOLLOWING CODES AS ADOPTED BY THE LOCAL GOVERNMENT (UNLESS OTHERWISE SPECIFIED). NOTHING IN THESE PLANS IS TO BE CONSIDERED TO PERMIT WORK NOT CONFORMING TO THESE CODES:

- 1: IRC - 2012
- 2: CALIFORNIA BUILDING STANDARDS CODE - 2013
- 3: CALIFORNIA GENERAL ORDER 95
- 4: CALIFORNIA ELECTRICAL CODE 2013
- 5: CALIFORNIA PLUMBING CODE 2013
- 6: CALIFORNIA ELECTRICAL CODE 2013
- 7: CALIFORNIA MECHANICAL CODE 2013
- 8: 2012 INTERNATIONAL FIRE CODE
- 9: BUILDING OFFICIALS AND CODE ADMINISTRATORS (BOCA) - EFFECTIVE UNTIL JANUARY 1ST, 2017

PROJECT DESCRIPTION

THESE REMAINS REPRESENT THE INSTALLATION OF A WIRELESS TELECOMMUNICATIONS TOWER IN THE PUBLIC RIGHT OF WAY. HARDWARE AND ACCESSORY EQUIPMENT TO BE INSTALLED AS DESCRIBED HEREIN.

GENERAL PROJECT NOTES

1. PRIOR TO SUBMITTING A BID, THE CONTRACTOR SHALL FAMILIARIZE HIMSELF WITH THE SCOPE OF WORK AND ALL CONDITIONS AFFECTING THE NEW PROJECT.
2. CONTRACTOR SHALL VERIFY ALL FIELD CONDITIONS AND ACCURACY OF THESE DATA AND CONFIRM THAT WORK AS INDICATED ON THESE PLANS IS TO BE COMPLETED WITHOUT DELAY AS SHOWN PRIOR TO COMMENCEMENT OF ANY WORK.
3. ALL CONDITIONS BEFORE, DURING OR AFTER CONSTRUCTION SHALL BE APPROVED IN WRITING BY AN EXTERNET SYSTEMS REPRESENTATIVE.
4. INSTALL ALL EQUIPMENT AND MATERIALS PER THE MANUFACTURER'S RECOMMENDATIONS, UNLESS INDICATED OTHERWISE.
5. NOTIFY EXTERNET SYSTEMS, IN WRITING, OF ANY MAJOR CONDITIONS THAT MAY AFFECT THE PROJECT DURING CONSTRUCTION AND DESIGN INTENT. THE CONTRACTOR SHALL BE RESPONSIBLE FOR OBTAINING CLARIFICATIONS FROM AN EXTERNET SYSTEMS REPRESENTATIVE, AND ADJUSTING THE BID ACCORDINGLY.
6. CONTRACTOR SHALL BE SOLELY RESPONSIBLE FOR ALL CONSTRUCTION MEANS, METHODS, TECHNIQUES, SEQUENCES AND PROCEDURES OF THE WORK UNDER THE CONTRACT.
7. CONTRACTOR SHALL PROTECT ALL EXISTING IMPROVEMENTS AND UTILITIES. THE CONTRACTOR SHALL BE RESPONSIBLE FOR DAMAGE THAT MAY OCCUR DURING THE CONSTRUCTION TO THE SATISFACTION OF AN EXTERNET SYSTEMS REPRESENTATIVE.
8. CONTRACTOR PLANS TO ILLUSTRATE THE AS-BUILT CONDITION OF EXISTING UTILITIES. THE CONTRACTOR SHALL PROVIDE EXTERNET SYSTEMS WITH ONE COPY OF ALL RED-LINED DRAWINGS.
9. VERIFY ALL FINAL EQUIPMENT WITH AN EXTERNET SYSTEMS REPRESENTATIVE. ALL EQUIPMENT LAYOUT, SPECS, PERFORMANCE REQUIREMENTS, AND CONSTRUCTION SHALL BE APPROVED BY EXTERNET SYSTEMS. THE CONTRACTOR SHALL BE RESPONSIBLE FOR OBTAINING CLARIFICATIONS FROM AN EXTERNET SYSTEMS REPRESENTATIVE. ALL WORK SHALL BE COMPLETED WITHIN THE TIME FRAME REQUIRED BY ORDERS RELATED TO 340 INSTALLATIONS.



UNDERGROUND SERVICE ALERT
UTILITIES PROTECTION CENTER, INC.
811
48 STATES SERVICE 700 876



INTERNAL REVIEW	DATE
CONSTRUCTION SIGNATURE	DATE
RF SIGNATURE	DATE
FINAL REVIEW SIGNATURE	DATE

BLACK & VEATCH
BLACK & VEATCH CORPORATION
2959 DAK ROAD
SUITE 500
WALNUT CREEK, CA 94597

THESE DRAWINGS ARE COMPUTERIZED AND ARE THE PROPERTY OF BLACK & VEATCH. NO PART OF THESE DRAWINGS IS TO BE REPRODUCED OR TRANSMITTED IN ANY FORM OR BY ANY MEANS, ELECTRONIC OR MECHANICAL, WITHOUT WRITTEN CONSENT BY BLACK & VEATCH.

PROJECT NO.	DRAWN BY	CHECKED BY
1924174291	DMS	CAC

NO.	DATE	DESCRIPTION
1	06/27/16	ISSUED FOR PERMITS
2	07/27/16	ISSUED FOR PERMITS

PRELIMINARY

THIS DRAWING IS FOR INFORMATION ONLY. IT DOES NOT CONSTITUTE A CONTRACT. THE CONTRACTOR SHALL BE RESPONSIBLE FOR OBTAINING ALL NECESSARY PERMITS AND APPROVALS FROM THE LOCAL GOVERNMENT.

EXTERNET SYSTEMS (CA) LLC
2000 CROW CANYON PLACE
SUITE 210
SAN RAMON, CA 94583

SITE ADDRESS
ADJACENT TO (IN PROX)
1700 SEMINARY AVENUE
OAKLAND, CA 94621

SHEET TITLE
TITLE SHEET

SHEET NUMBER
T-1

PROJECT INFORMATION

<p>OWNER EXTERNET SYSTEMS CA, LLC ADDRESS: 2000 CROW CANYON PL., SUITE 210 SAN RAMON, CA 94583 PHONE:</p>	<p>POLE OWNER EXTERNET SYSTEMS CA, LLC ADDRESS: 2000 CROW CANYON PL., SUITE 210 SAN RAMON, CA 94583 PHONE:</p>	<p>APPLICANT COMPANY: EXTERNET SYSTEMS (CALIFORNIA), LLC CONTACT: MATTHEW YERGOVICH ADDRESS: 2000 CROW CANYON PL., SUITE 210 SAN RAMON, CA 94583 PHONE: (415) 598-3474 E-MAIL: MYERGOVICH@EXTERNETSYSTEMS.COM</p>	<p>PROJECT DATA LATITUDE: 37.7681 LONGITUDE: -122.197322 POLE #: X0000X ELEVATION: NA CITY OF OAKLAND ZONING DISTRICT: RM-4 NEAREST A.P.N.: 38-3215-1 OCCUPANCY: U. UNMANNED CONSTRUCTION TYPE: ATTACHMENTS TO A METAL/STEEL LIGHT POLE TITLE 24 REQUIREMENTS: FACILITY IS UNMANNED AND NOT FOR HUMAN HABITATION. THIS PROJECT IS SUBJECT</p>
<p>AGENT COMPANY: BLACK & VEATCH CONTACT: ANA GOMEZ ADDRESS: 2959 DAK ROAD, SUITE 500 WALNUT CREEK, CA 94597 PHONE: (913) 458-9148 E-MAIL: GOMEZANAC@BV.COM</p>	<p>ENGINEER COMPANY: BLACK & VEATCH ENGINEER: AMYON EVANS PHONE: (925) 898-0751 E-MAIL: EVANSAM@BV.COM</p>		

SHEET INDEX

SHEET NO.	SHEET TITLE
T-1	TITLE SHEET
GM-1	GENERAL NOTES AND LEGEND
C-1	OVERALL SITE PLAN
C-2	UTILITY POLE ELEVATIONS AND RISER DETAILS
	EQUIPMENT DETAILS

*X17" PLOT, DRAWINGS WILL BE HALF SCALE

OR SHALL VERIFY ALL PLANS & EXISTING DIMENSIONS & CONDITIONS ON SITE. SHALL IMMEDIATELY NOTIFY THE ENGINEER IN WRITING OF ANY DISCREPANCIES OR OMISSIONS. THE CONTRACTOR SHALL BE RESPONSIBLE FOR SAME.

extenei reconnectivity everywhere
SYSTEMS

INTERNAL REVIEW

CONSTRUCTION SIGNATURE _____ DATE _____
 RF SIGNATURE _____ DATE _____
 DEPT. LEAD SIGNATURE _____ DATE _____

BLACK & VEATCH

BLACK & VEATCH CORPORATION
 2895 OAK BOND, SUITE 400
 WALNUT CREEK, CA 94597

THESE DRAWINGS ARE UNREVISED AND ARE THE PROPERTY OF BLACK & VEATCH. NO PART OF THESE DRAWINGS IS TO BE REPRODUCED OR TRANSMITTED IN ANY FORM OR BY ANY MEANS, ELECTRONIC OR MECHANICAL, INCLUDING PHOTOCOPYING, RECORDING, OR BY ANY INFORMATION CONTAINED WITHIN THIS DRAWING IS PROHIBITED WITHOUT WRITTEN CONSENT BY BLACK & VEATCH.

PROJECT NO. DRAWN BY CHECKED BY

192417.4291	DMS	CAC
-------------	-----	-----

REV	DATE	DESCRIPTION
B	09/22/18	ISSUED FOR RFP
A	09/27/18	ISSUED FOR RFP

PRELIMINARY

IT IS A VIOLATION OF LAW FOR ANY PERSON, FIRM OR CORPORATION TO REPRODUCE, TRANSMIT, OR IN ANY MANNER TO ALTER THIS DOCUMENT.

EXTENET SYSTEMS (CA) LLC
 2000 CROW CANYON PLACE
 SUITE 210
 SAN RAMON, CA 94583

SITE ADDRESS
 ADJACENT TO (IN PROX)
 1700 SEMINARY AVENUE
 OAKLAND, CA 94621

SHEET TITLE
OVERALL SITE PLAN

SHEET NUMBER
C-1

THIS DRAWING IS NOT A SITE SURVEY. THE DRAWING IS TO SHOW HOW THE DEVELOPER RELATES TO THE PARENT PARCEL AND MEASUREMENTS ARE APPROXIMATIONS.

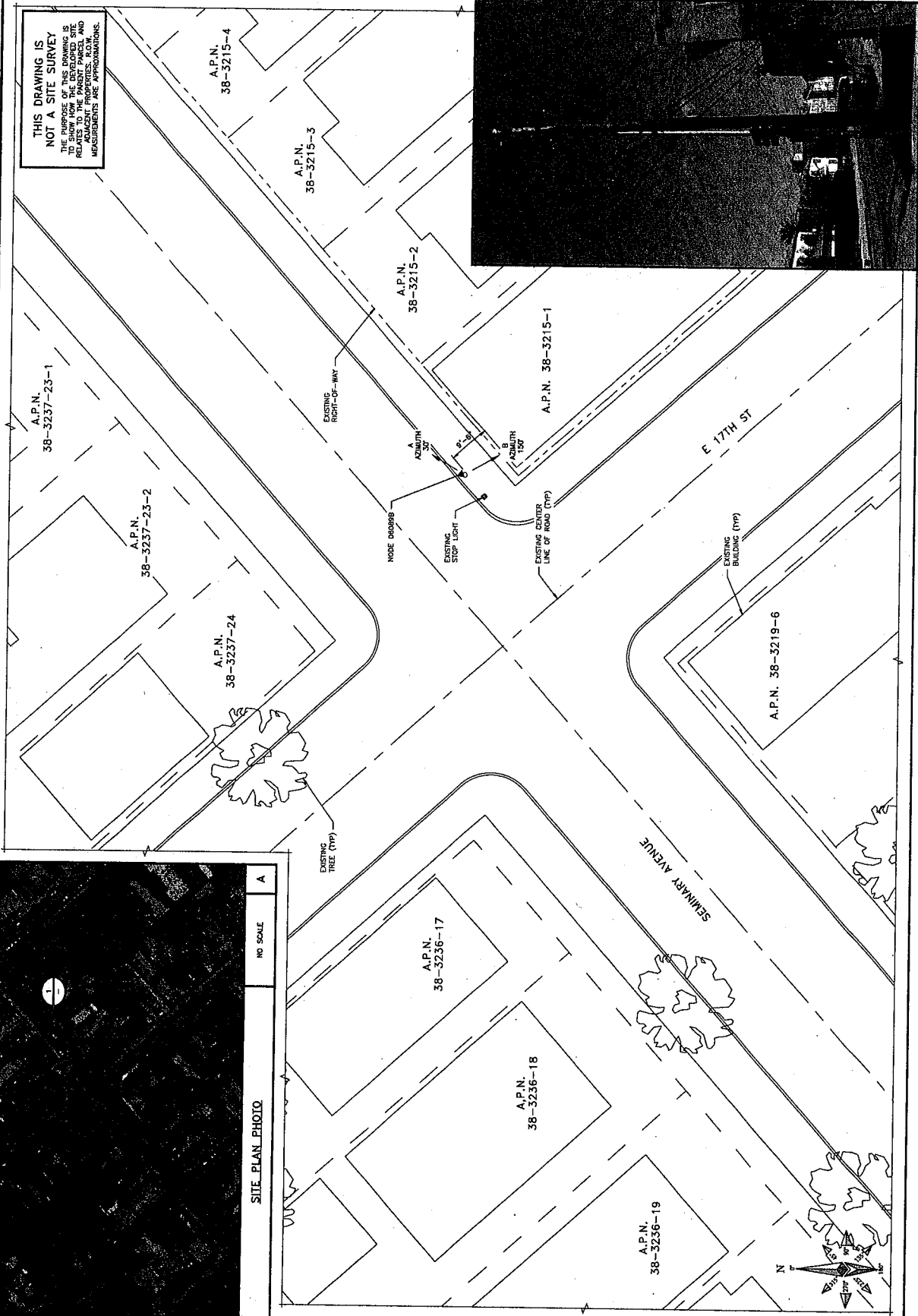

OVERALL SITE PLAN



INTERNAL REVIEW	DATE
CONSTRUCTION SIGNATURE	DATE
RF SIGNATURE	DATE
REAL ESTATE SIGNATURE	DATE

BLACK & VEATCH
 BLACK & VEATCH CORPORATION
 2959 DIX ROAD
 WALNUT CREEK, CA 94597

THESE DRAWINGS ARE COPYRIGHTED AND ARE THE PROPERTY OF BLACK & VEATCH. ANY REPRODUCTION OR USE OF THE INFORMATION CONTAINED WITHIN SAID DRAWINGS WITHOUT THE WRITTEN CONSENT OF BLACK & VEATCH.

PROJECT NO.	DMS	DAC
192417.4291		
DATE	REVISION	
06/22/14	1	06/22/14
06/10/14	2	06/10/14

PRELIMINARY

IF A MODIFICATION OF ANY KIND IS REQUIRED, THE CLIENT MUST BE NOTIFIED IN WRITING AND THE DRAWING MUST BE REVISED AND RE-APPROVED TO ALTER THIS DOCUMENT.

EXTENET SYSTEMS (CA) LLC
 2000 CROW CANYON PLACE
 SUITE 210
 SAN RAMON, CA 94583

SHEET TITLE
 UTILITY POLE ELEVATIONS
 AND RISER DETAILS

SHEET NUMBER
C-2

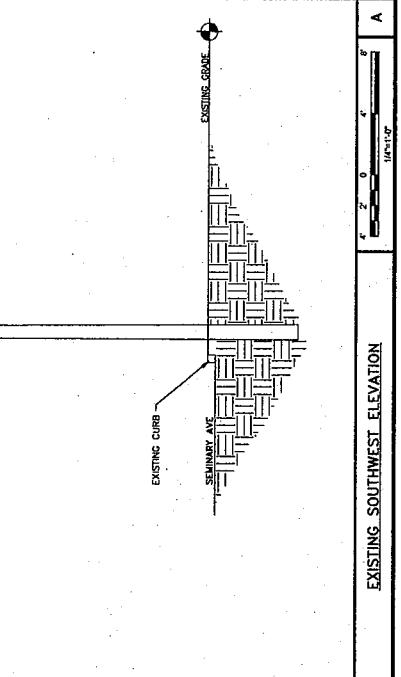
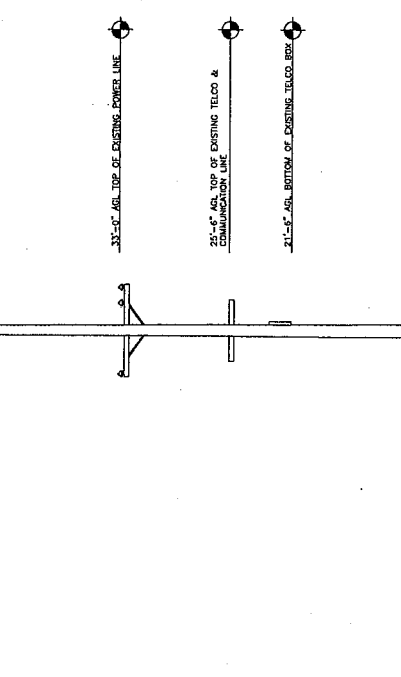
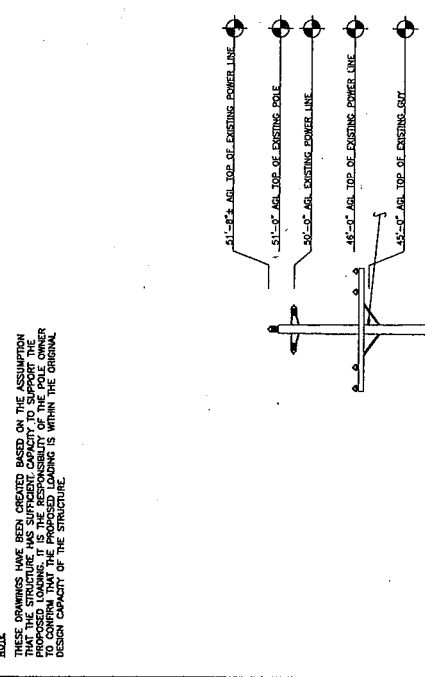
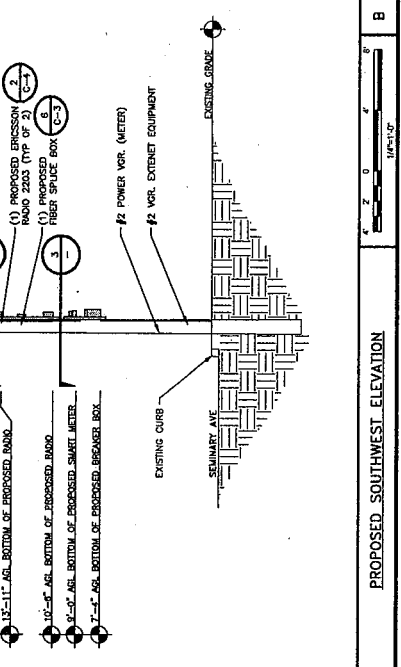
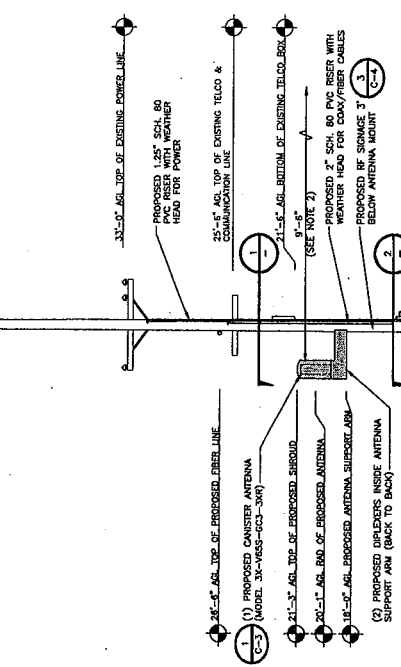
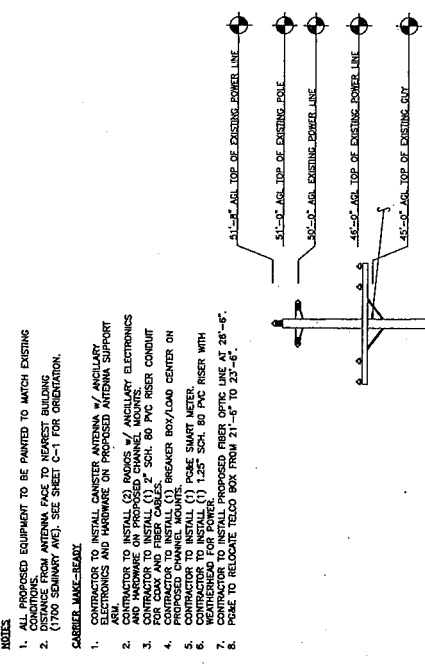
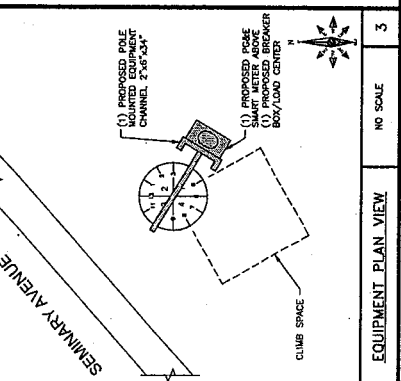
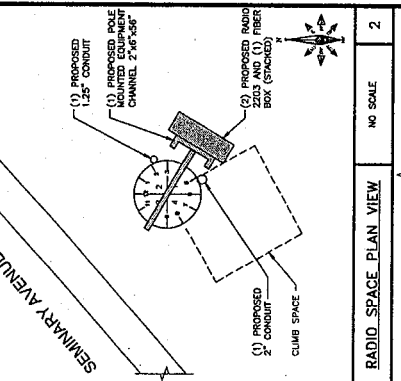
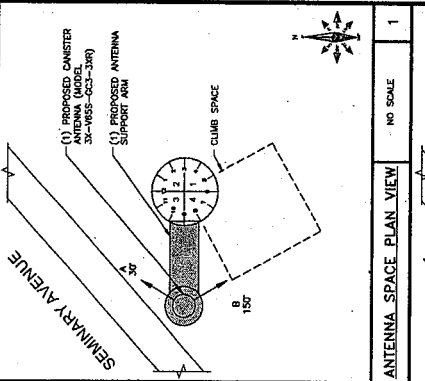

- INDEX**
- PROPOSED EQUIPMENT TO BE PAINTED TO MATCH EXISTING CONDITIONS.
 - DISTANCE FROM ANTENNA FACE TO NEAREST BUILDING (1700 SEMINARY AVE). SEE SHEET C-1 FOR ORIENTATION.
 - CARRIER MAKE-BEANS
 - CONTRACTOR TO INSTALL CANISTER ANTENNA w/ ANCILLARY ELECTRONICS AND HARDWARE ON PROPOSED ANTENNA SUPPORT AND HARDWARE ON PROPOSED CHANNEL MOUNT.
 - CONTRACTOR TO INSTALL (2) RADIOS w/ ANCILLARY ELECTRONICS AND HARDWARE ON PROPOSED CHANNEL MOUNT.
 - FOR COAX AND RISER CABLES: 3" SCH. 80 PVC RISER CONDUIT ON PROPOSED CHANNEL MOUNT.
 - CONTRACTOR TO INSTALL (1) BREAKER BOX/LOAD CENTER ON PROPOSED CHANNEL MOUNT.
 - CONTRACTOR TO INSTALL (1) POLE SMART METER.
 - CONTRACTOR TO INSTALL (1) 1.25" SCH. 80 PVC RISER WITH PROPOSED SMART METER.
 - CONTRACTOR TO INSTALL PROPOSED FIBER OPTIC LINE AT 26'-6".
 - POLE TO RELOCATE TELCO BOX FROM 21'-8" TO 23'-6".

NOTES:
 THESE DRAWINGS HAVE BEEN CREATED BASED ON THE ASSUMPTION THAT THE STRUCTURE HAS SUFFICIENT CAPACITY TO SUPPORT THE WEIGHT OF THE ANTENNA. THE CONTRACTOR IS RESPONSIBLE FOR VERIFYING THE DESIGN CAPACITY OF THE STRUCTURE.

PROPOSED ANTENNA

FRAME COLOR: LIGHT GREY
 FRAME MATERIAL: FIBERGLASS, UV RESISTANT
 DIAMETER: 7.8" (200mm)
 HEIGHT: 23.5" (596mm)
 TOTAL WEIGHT (WITHOUT BRACKETS): 7.2 kg (15.9 LB)
 CONNECTOR INTERFACE: 4.1-9.5 DIN FEMALE
 RF CONNECTOR LOCATION: BOTTOM
 RF CONNECTOR QUANTITY: 6

PROPOSED ANTENNA

NO SCALE

ANTENNA SHROUD PARTS TABLE

E1-4868-FSS FUSION SPLICE ENCLOSURE

DEPTH: 2 1/8" (0)
 HEIGHT: 6 3/4" (0)
 WIDTH: 4 3/4" (0)

ITEM #	PART #	DESCRIPTION	QTY	UNIT WT. (LBS)
1	WA-714	STANDOFF ARM ASSEMBLY PARTS / HOUR	1	4.5
2	SS-514	3/16" X 1/8" X 3/8" STANDOFF ARM W/ MOUNT	2	0.5
3	SS-514	2" X 2 1/4" X 3/8" ANGLE	1	0.4
4	SS-514	2" X 2 1/4" X 3/8" ANGLE	4	0.1
5	11320	3/8" X 1/2" FULLY THROD BOLT / MOUNT GALV.	2	0.01
6	11010	11010 1/2" X 1/2" HEX NUT, GALV.	2	0.01
7	80255	3/8" X 1/2" HEX NUT, GALV.	2	0.01
8	80255	3/8" X 1/2" HEX NUT, GALV.	1	0.19
9	PL-716	BUS BAR ASSEMBLY PARTS / HOUR	1	0.8
10	45710	3/8" X 1/2" LOCK WASHER, GALV.	4	0.01
11	71017	3/8" X 1/2" FULLY THROD S.S. BOLT	4	0.04
12	80255	3/8" X 1/2" FULLY THROD S.S. BOLT	2	0.1
13	16259	3/8" X 1/2" FULLY THROD BOLT, GALV.	1	2.2
14	41010	3/8" X 1/2" LOCK WASHER, GALV.	2	0.01
15	51000	3/8" X 1/2" HEX NUT, GALV.	2	0.02
16	WA-716	ANTENNA / EQUIPMENT MOUNT PARTS / HOUR	1	2.2
17	WA-716	1/2" X 1/2" X 1/2" U.S. E.C. FORMED PLATE W/ MOUNT	1	0
18	WA-716	1/2" X 1/2" X 1/2" U.S. E.C. FORMED PLATE W/ MOUNT	1	0
19	PL-1324	1/2" X 1/2" X 1/2" U.S. E.C. FORMED PLATE W/ MOUNT	1	9.9
20	PL-1324	1/2" X 1/2" X 1/2" U.S. E.C. FORMED PLATE W/ MOUNT	1	9.9
21	PL-1324	1/2" X 1/2" X 1/2" U.S. E.C. FORMED PLATE W/ MOUNT	1	0.3
22	142824-4	1/2" X 1/2" X 1/2" U.S. E.C. FORMED PLATE	2	0.1
23	45620	1/2" X 1/2" X 1/2" U.S. E.C. FORMED PLATE	16	0.02
24	70217	1/4" X 1/2" SS FLAT BUTTON-HD SCRT CAP SCRW	18	0.003
25	70218	1/4" X 1/2" SS FLAT BUTTON-HD SCRT CAP SCRW	18	0.003
TOTAL GALV. WT. = BRHS				

ANTENNA SHROUD PARTS TABLE

NO SCALE

4 3/4"

2 1/8"

6 3/4"

4 3/4"

ANTENNA SHROUD PARTS TABLE

NO SCALE

2 1/8"

6 3/4"

4 3/4"

ANTENNA SHROUD PARTS TABLE

NO SCALE

2 1/8"

6 3/4"

4 3/4"

ANTENNA SHROUD PARTS TABLE

NO SCALE

2 1/8"

6 3/4"

4 3/4"

PROPOSED ANTENNA

NO SCALE

ANTENNA SHROUD PARTS TABLE

NO SCALE

ANTENNA SHROUD PARTS TABLE

NO SCALE

ANTENNA SHROUD PARTS TABLE

NO SCALE

ANTENNA SHROUD PARTS TABLE

NO SCALE

ANTENNA SHROUD PARTS TABLE

NO SCALE

ANTENNA SHROUD PARTS TABLE

NO SCALE

ANTENNA SHROUD PARTS TABLE

NO SCALE

PROPOSED ANTENNA

NO SCALE

ANTENNA SHROUD PARTS TABLE

NO SCALE

ANTENNA SHROUD PARTS TABLE

NO SCALE

ANTENNA SHROUD PARTS TABLE

NO SCALE

ANTENNA SHROUD PARTS TABLE

NO SCALE

ANTENNA SHROUD PARTS TABLE

NO SCALE

ANTENNA SHROUD PARTS TABLE

NO SCALE

ANTENNA SHROUD PARTS TABLE

NO SCALE

PROPOSED ANTENNA

NO SCALE

ANTENNA SHROUD PARTS TABLE

NO SCALE

ANTENNA SHROUD PARTS TABLE

NO SCALE

ANTENNA SHROUD PARTS TABLE

NO SCALE

ANTENNA SHROUD PARTS TABLE

NO SCALE

ANTENNA SHROUD PARTS TABLE

NO SCALE

ANTENNA SHROUD PARTS TABLE

NO SCALE

ANTENNA SHROUD PARTS TABLE

NO SCALE

PROPOSED ANTENNA

NO SCALE

ANTENNA SHROUD PARTS TABLE

NO SCALE

ANTENNA SHROUD PARTS TABLE

NO SCALE

ANTENNA SHROUD PARTS TABLE

NO SCALE

ANTENNA SHROUD PARTS TABLE

NO SCALE

ANTENNA SHROUD PARTS TABLE

NO SCALE

ANTENNA SHROUD PARTS TABLE

NO SCALE

ANTENNA SHROUD PARTS TABLE

NO SCALE

PROPOSED ANTENNA

NO SCALE

ANTENNA SHROUD PARTS TABLE

NO SCALE

ANTENNA SHROUD PARTS TABLE

NO SCALE

ANTENNA SHROUD PARTS TABLE

NO SCALE

ANTENNA SHROUD PARTS TABLE

NO SCALE

ANTENNA SHROUD PARTS TABLE

NO SCALE

ANTENNA SHROUD PARTS TABLE

NO SCALE

ANTENNA SHROUD PARTS TABLE

NO SCALE

PROPOSED ANTENNA

NO SCALE

ANTENNA SHROUD PARTS TABLE

NO SCALE

ANTENNA SHROUD PARTS TABLE

NO SCALE

ANTENNA SHROUD PARTS TABLE

NO SCALE

ANTENNA SHROUD PARTS TABLE

NO SCALE

ANTENNA SHROUD PARTS TABLE

NO SCALE

ANTENNA SHROUD PARTS TABLE

NO SCALE

ANTENNA SHROUD PARTS TABLE

NO SCALE

PROPOSED ANTENNA

NO SCALE

ANTENNA SHROUD PARTS TABLE

NO SCALE

ANTENNA SHROUD PARTS TABLE

NO SCALE

ANTENNA SHROUD PARTS TABLE

NO SCALE

ANTENNA SHROUD PARTS TABLE

NO SCALE

ANTENNA SHROUD PARTS TABLE

NO SCALE

ANTENNA SHROUD PARTS TABLE

NO SCALE

ANTENNA SHROUD PARTS TABLE

NO SCALE

PROPOSED ANTENNA

NO SCALE

ANTENNA SHROUD PARTS TABLE

NO SCALE

ANTENNA SHROUD PARTS TABLE

NO SCALE

ANTENNA SHROUD PARTS TABLE

NO SCALE

ANTENNA SHROUD PARTS TABLE

NO SCALE

ANTENNA SHROUD PARTS TABLE

NO SCALE

ANTENNA SHROUD PARTS TABLE

NO SCALE

ANTENNA SHROUD PARTS TABLE

NO SCALE

PROPOSED ANTENNA

NO SCALE

ANTENNA SHROUD PARTS TABLE

NO SCALE

ANTENNA SHROUD PARTS TABLE

NO SCALE

ANTENNA SHROUD PARTS TABLE

NO SCALE

ANTENNA SHROUD PARTS TABLE

NO SCALE

ANTENNA SHROUD PARTS TABLE

NO SCALE

ANTENNA SHROUD PARTS TABLE

NO SCALE

ANTENNA SHROUD PARTS TABLE

NO SCALE



INTERNAL REVIEW
 CONSTRUCTION SIGNATURE _____ DATE _____
 RF SIGNATURE _____ DATE _____
 REAL ESTATE SIGNATURE _____ DATE _____

BLACK & VEATCH
 BLACK & VEATCH CORPORATION
 2895 OAK ROAD
 WALNUT CREEK, CA 94597

THESE DRAWINGS ARE COPYRIGHTED AND ARE THE PROPERTY OF BLACK & VEATCH. ANY REPRODUCTION OR USE OF THE INFORMATION CONTAINED HEREIN WITHOUT WRITTEN CONSENT BY BLACK & VEATCH.

PROJECT NO. DRAWN BY CHECKED BY
 192417-4291 DNS GAC
 08/22/18 ISSUED FOR RFP
 09/19/18 ISSUED FOR RFP
 REV. DATE DESCRIPTION

PRELIMINARY
 IT IS A VIOLATION OF LAW FOR ANY PERSON, UNLESS THEY ARE AWARE UNDER THE DIRECTION OF A PE, TO ALTER THIS DOCUMENT.

EXTENET SYSTEMS (CA) LLC
 2000 CROFT CANTON PLACE
 SUITE 210
 SAN RAMON, CA 94583

SITE ADDRESS
 ADJACENT TO (IN PROW)
 1700 SEMINARY AVENUE
 OAKLAND, CA 94621

SHEET TITLE
 EQUIPMENT DETAILS

SHEET NUMBER
C-4

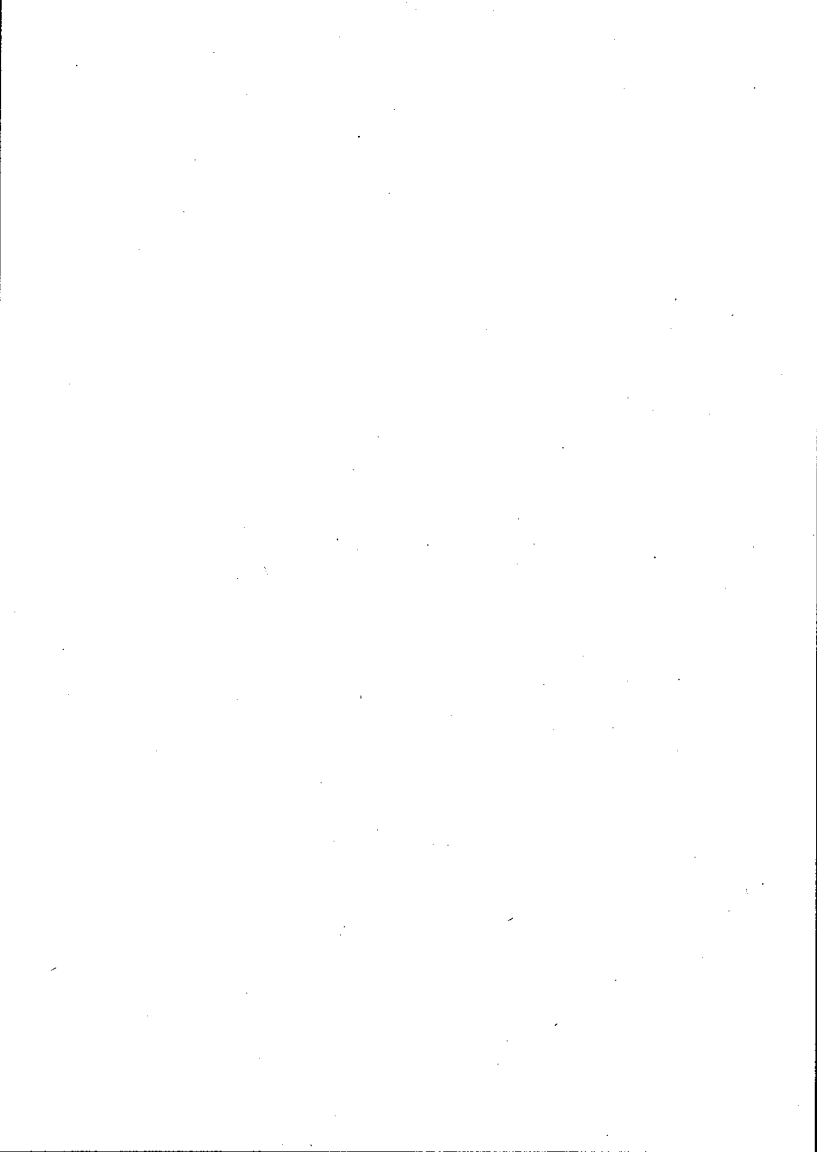
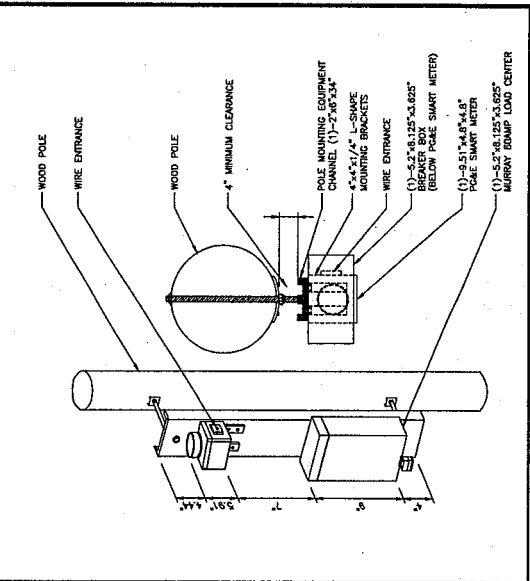
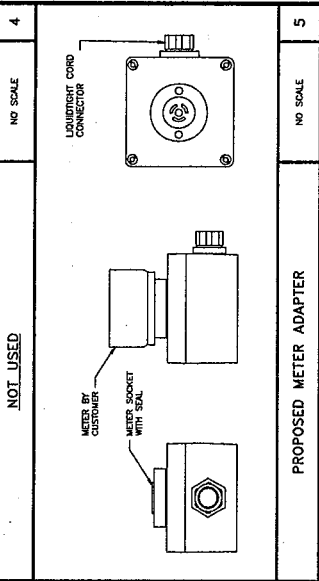
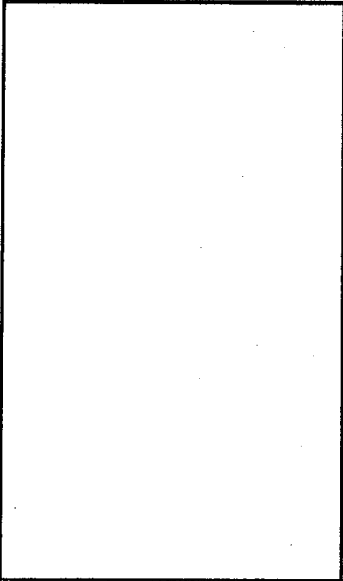

NO SCALE

CAUTION

Beyond This Point you are entering a controlled area where RF emissions may exceed the FCC Occupational Exposure Limits. Obey all posted signs and site guidelines for working in a RF environment.

84-1028-1.130703
 84-1028-1.130703

NO SCALE

NOTICE

Beyond This Point you are entering a controlled area where RF emissions may exceed the FCC General Population Exposure Limits. Follow all posted signs and site guidelines for working in a RF environment.

84-1028-1.130703
 84-1028-1.130703

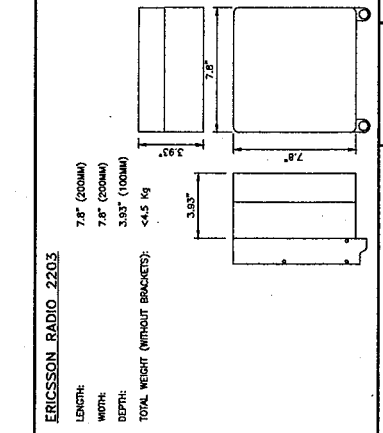

SMART_METER/BREAKER_BOX_DETAIL

RF_SIGNAGE_DETAIL

RADIO_SPECIFICATION_DETAIL

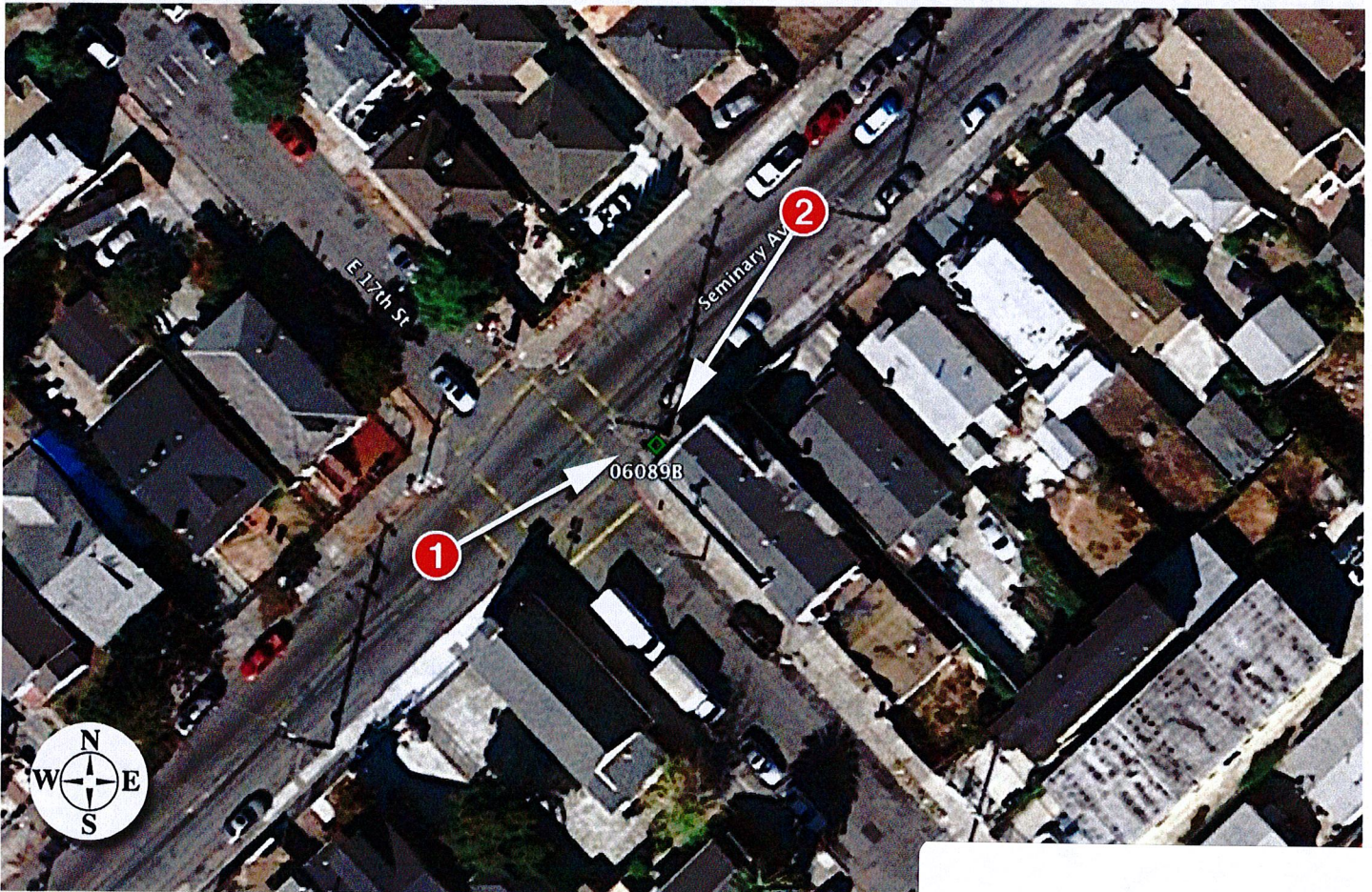

ATTACHMENT D



Existing



Proposed



Existing



Proposed



October 14, 2016

City Planner
Planning Department
City of Oakland
250 Frank Ogawa Plaza, 2nd Floor
Oakland, CA 94612

Re: Proposed ExteNet Small Cell Node Installation
Applicant: ExteneNet Systems (California) LLC
Nearest Site Address: Public Right of Way near 1700 Seminary Avenue
Site ID: NW-CA-SANFRANMC Node 06089B
Latitude/Longitude: 37.766608, -122.197322

Dear City Planner,

On behalf of ExteneNet Systems (California) LLC, this letter and attached materials are to apply for a design review permit to install a small cell node in the public right-of-way near 1700 Seminary Avenue (“Node 06089B”).¹ The following is an explanation of the existing site, a project description of the designed facility, the project purpose and justifications in support of this proposal.

A. Project Description.

The proposed location for our facility currently consists of an approximate 51 foot tall wood utility pole in the public right-of-way on the east side of Seminary Avenue just south of the intersection with Holway Street, at about 1700 Seminary Avenue. Power lines are on the pole at about 46 feet, 50 feet and 51 feet above ground.

ExteneNet proposes to utilize existing pole measuring 51 feet above ground and to affix one canister antenna within an antenna shroud on a proposed antenna support. The antenna, measuring 23.5 inches long and 7.9 inches in diameter will be placed on an antenna support arm attached at 18 feet. Two proposed diplexers measuring 6.4 inches long, 4.6 inches wide and 1.8 inches deep will be placed within the side arm antenna mount. Two MRRUs measuring 7.9 inches tall, 7.9 inches wide and 3.9 inches deep will be placed on the pole at 10 feet 6 inches and 13 feet 11 inches. A miniature emergency shut-off safety switch and electricity meter will be placed on the pole at about eight feet above ground. All equipment will be painted brown to match the utility pole. Our proposal is depicted in the attached design drawings and photographic simulations.

This is an unmanned facility that will operate at all times (24 hours per day, seven days per week) and will be serviced about once per year. Our proposal will greatly benefit the area by improving wireless telecommunications service as detailed below.

B. Project Purpose.

¹ ExteneNet expressly reserves all rights concerning the city’s jurisdiction to assert zoning regulation over the placement of wireless facilities in the public rights-of-way.

The purpose of this project is to provide T-Mobile third and fourth generation (3G and 4G) wireless voice and data coverage to the surrounding area where there is currently a significant gap in service coverage. These wireless services include mobile telephone, wireless broadband, emergency 911, data transfers, electronic mail, Internet, web browsing, wireless applications, wireless mapping and video streaming. The proposed node is part of a larger small cell providing coverage to areas of Oakland that are otherwise very difficult or impossible to cover using traditional macro wireless telecommunications facilities due to the local topography and mature vegetation. The attached radio frequency propagation maps depict T-Mobile's larger small cell project. Further radio frequency details are set forth in the attached Radio Frequency Statement, including propagation maps depicting existing and proposed coverage in the vicinity of Node 06089B.

A small cell network consists of a series of radio access nodes connected to small telecommunications antennas, typically mounted on existing wooden utility poles within the public rights-of-way, to distribute wireless telecommunications signals. Small cell networks provide telecommunications transmission infrastructure for use by wireless services providers. These facilities allow service providers such as T-Mobile to establish or expand their network coverage and capacity. The nodes are linked by fiber optic cable that carry the signal stemming from a central equipment hub to a node antenna. Although the signal propagated from a node antenna spans over a shorter range than a conventional tower system, small cell can be an effective tool to close service coverage gaps.

C. Project Justification, Alternative Site and Design Analysis.

Node 06089B is an integral part of the overall small cell project, and it is located in a difficult coverage area near Harmon Avenue. The coverage area consists of a primarily residential neighborhood off of Seminary Avenue, Bromley Avenue, Harmon Avenue, and surrounding areas. Node 06089B will cover transient traffic along the roadways and provide in-building service to the surrounding residences as depicted in the propagation maps, which are exhibits to the attached Radio Frequency Statement.

Based on ExteNet's analysis of alternative sites the currently proposed Node 06089B is the least intrusive means to close T-Mobile's significant service coverage gap in the area. Node 06089B best uses existing utility infrastructure, adding small equipment without disturbing the character of the neighborhoods served. Deploying a small cell node at an existing pole location minimizes any visual impact by utilizing an inconspicuous spot. By installing antennas and equipment at this existing pole location, T-Mobile does not need to propose any new infrastructure in this coverage area.

The small cell node RF emissions are also much lower than the typical macro site, they are appropriate for the area, and they are fully compliant with the FCC's requirements for limiting human exposure to radio frequency energy. The attached radio frequency engineering analysis provided by Hammett & Edison, Inc., Consulting Engineers, confirms that the proposed equipment will operate well within (and actually far below) all applicable FCC public exposure limits. The facility will also comply with California Public Utility Commission (CPUC) General Orders 95 (concerning overhead line design, construction and maintenance) and 170 (CEQA review) that govern utility use in the public right-of-way.

This proposed redesign is a viable design developed according to our discussions with the Planning Department. As discussed with City Planning, Node 06089B is the least intrusive option. Also the proposed location is a good coverage option because it sits at a spot from which point T-Mobile can adequately propagate its wireless signal.

ExteNet considered alternative sites on other utility poles in this area but none of these sites is as desirable from construction, coverage or aesthetics perspectives. The proposed location is approximately equidistant from other small cell nodes that ExteNet plans to place in surrounding hard-to-reach areas, so that service coverage can be evenly distributed. The proposed facility is not in the path of any protected view sheds. The other utility poles in the area are more conspicuous than the proposed pole. In addition to the utility pole proposed to host Node 06089B, ExteNet considered alternative sites set forth in the attached Alternative Site Analysis.

ExteNet Systems

2000 Crow Canyon Place, Suite 210 • San Ramon, CA 94583
(415) 596-3474 • myergovich@extenetsystems.com

Alternative designs were considered including placing equipment inside of a ground-mounted cabinet. However, the pole-mounted equipment would better suit the area because it would blend in with the pole. We also evaluated whether equipment could be undergrounded but unfortunately this is not possible because there is insufficient right-of-way space for the necessary equipment access and the equipment would be compromised from saturation by rainwater. The antennas cannot be undergrounded because they rely on a line-of-site in order to properly transmit a signal.

Drawings, propagation maps, photographic simulations, and a radio-frequency engineering analysis are included with this packet.

As this application seeks authority to install a wireless telecommunication facility, the FCC's Shot Clock Order² requires the city to issue its final decision on ExteNet's application within 150 days. We respectfully request expedited review and approval of this application. Feel free to contact me if you have any questions. Thank you.

Thank you.

Best Regards,
EXTENET SYSTEMS

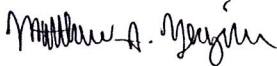

Matthew S. Yergovich

² See Petition for Declaratory Ruling to Clarify Provisions of Section 332(c)(7)(B), WT Docket No. 08-165, Declaratory Ruling, 24 F.C.C.R. 13994 (2009).



EXTENET OAKLAND NODE 06089B ALTERNATIVE SITE ANALYSIS

MAP OF ALTERNATIVE POLES EVALUATED FOR NODE 06089B



- The above maps depict ExteneNet's proposed Node 06089B in relation to other poles in the area that were evaluated as possibly being viable alternative candidates.
- The following is an analysis of each of those 3 alternative locations.

PROPAGATION MAP OF NODE 06089B

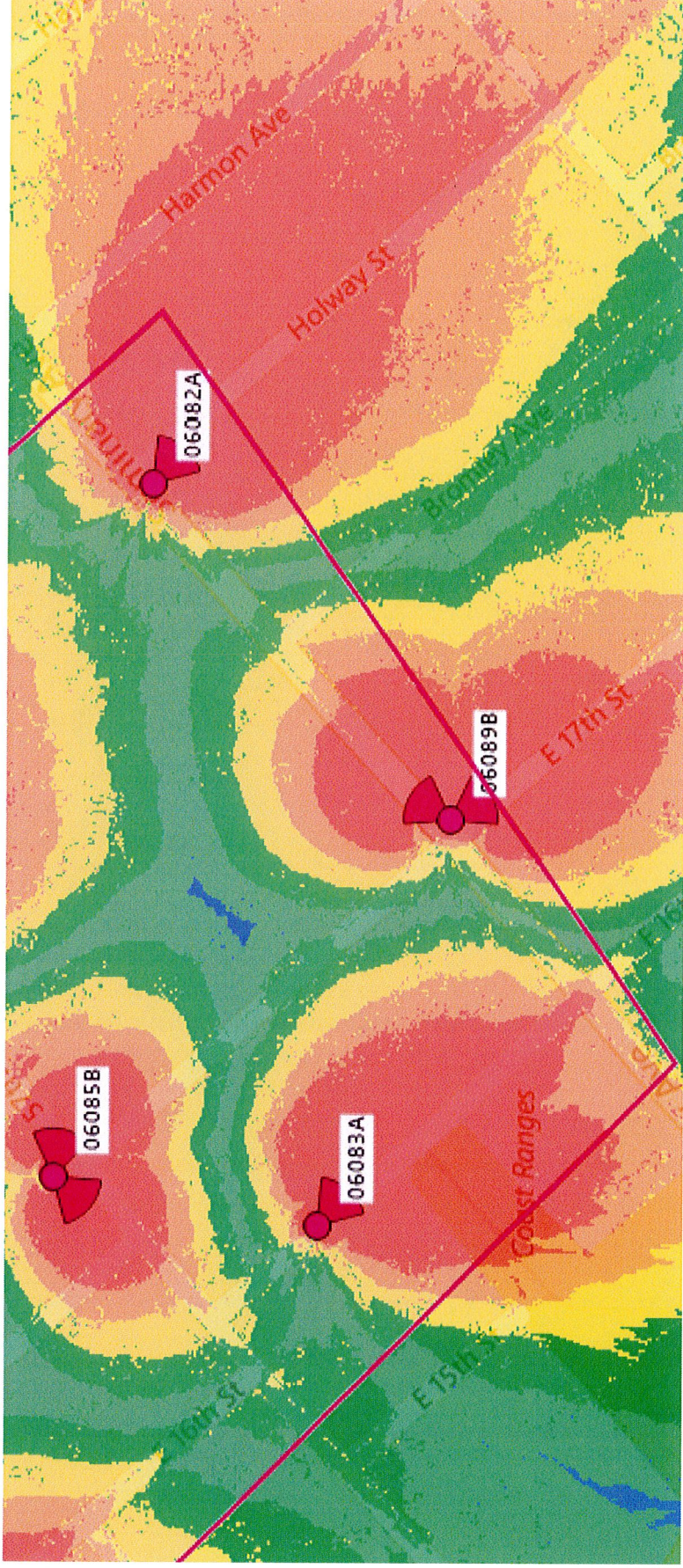

This propagation map depicts the ExteNet proposed Node 06089B in relation to surrounding proposed ExteNet small cell nodes.

06089B - PROPOSED LOCATION



- The location for ExteNet's proposed Node 06089B is a joint utility pole located at 1700 Seminary Avenue (wooden pole), (37.766608, -122.197322).
- ExteNet's objective is to provide T-Mobile 4G wireless coverage and capacity to the Oakland area.
- ExteNet evaluated this site and nearby alternatives to verify that the selected site is the least intrusive means to close T-Mobile's significant service coverage gap.

ALTERNATIVE NODE 06089A



- Node 06089A is a metal light pole next to 1627 Seminary Avenue (37.787881, -122.219384).
- This pole is not a viable alternative because it has an existing traffic signal light.
- This pole is not a viable alternative candidate because this pole is located too close to primary Node 06083A.
- This pole is not a viable alternative candidate because this pole increases the primary service gap from 06082A.

ALTERNATIVE NODE 06089C



- Node 06089C is a metal light pole at 1700 Seminary Avenue, Oakland, CA (on corner in front of La Raza Market next to wooden pole), (37.766598, -122.197342)
- This is pole is not a viable alternative because it has an existing traffic signal light.

ALTERNATIVE NODE 06089D



- Node 06089D is a joint utility pole near 5900-5922 E 17th Street, Oakland, CA, 94621 (on side of Building of La Raza market), (37.766512, -122.197277).
- This pole is not a viable alternative candidate because cross lines and cross arms prevent adequate climbing space on the pole pursuant to CPUC General Order 95, thus prohibiting a wireless facility from being installed at this location.
- This pole is not a viable alternative candidate because this pole is located too far from primary Node 06083A.

ALTERNATIVE SITE ANALYSIS CONCLUSION

Based on ExteNet's analysis of alternative sites, the currently proposed Node 06089B is the least intrusive location from which to fill the surrounding significant wireless coverage gaps.

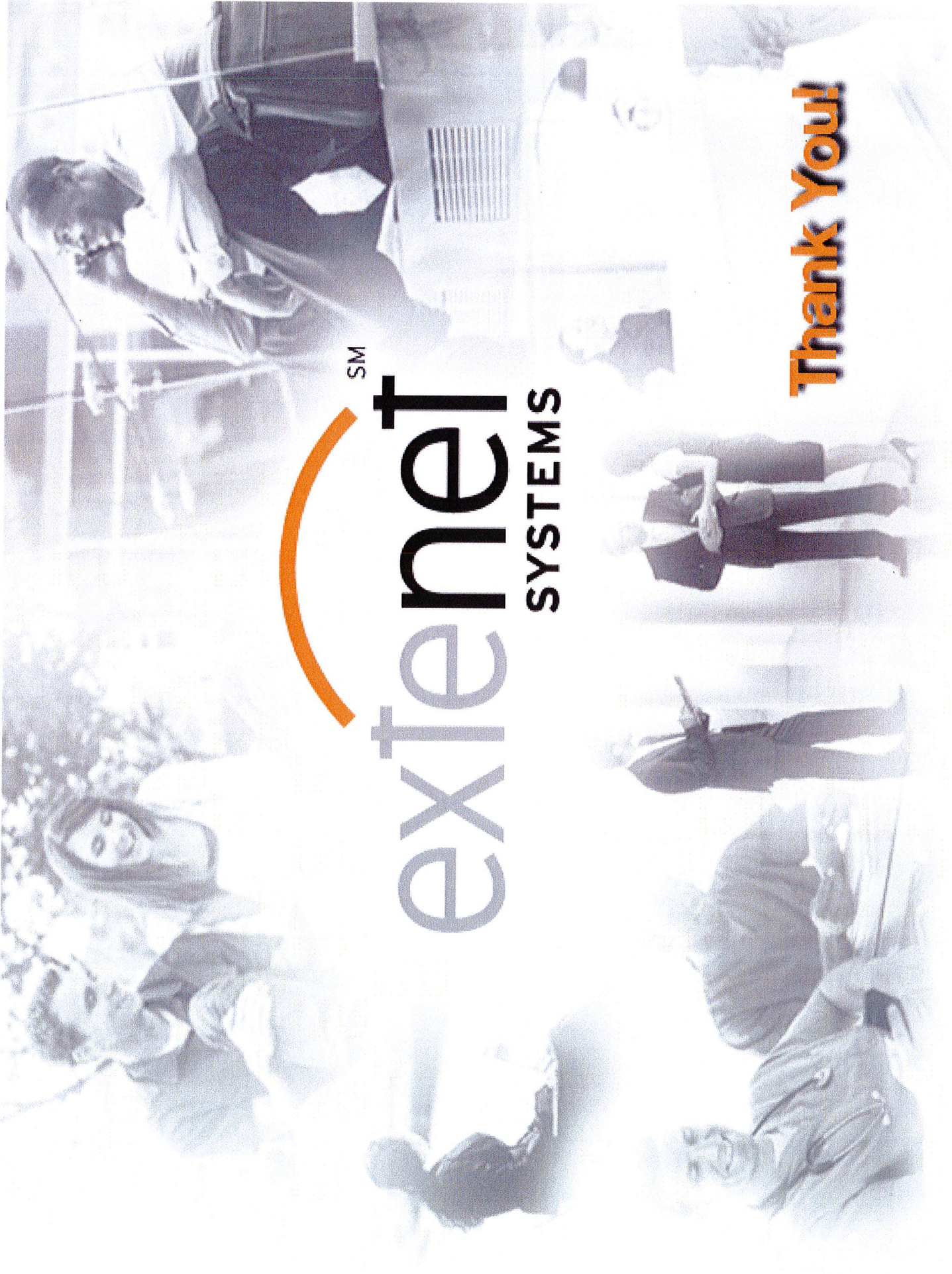

SM
extenet
SYSTEMS

Thank You!

**ExteNet Systems CA, LLC • Proposed DAS Node (Site No. 06089B)
1700 Seminary Avenue • Oakland, California**

Statement of Hammett & Edison, Inc., Consulting Engineers

The firm of Hammett & Edison, Inc., Consulting Engineers, has been retained on behalf of ExteNet Systems CA, LLC, a wireless telecommunications carrier, to evaluate the addition of Node No. 06089B to be added to the ExteNet distributed antenna system (“DAS”) in Oakland, California, for compliance with appropriate guidelines limiting human exposure to radio frequency (“RF”) electromagnetic fields.

Executive Summary

ExteNet proposes to install a directional panel antenna on a utility pole sited in the public right-of-way at 1700 Seminary Avenue in Oakland. The proposed operation will comply with the FCC guidelines limiting public exposure to RF energy.

Prevailing Exposure Standards

The U.S. Congress requires that the Federal Communications Commission (“FCC”) evaluate its actions for possible significant impact on the environment. A summary of the FCC’s exposure limits is shown in Figure 1. These limits apply for continuous exposures and are intended to provide a prudent margin of safety for all persons, regardless of age, gender, size, or health. The most restrictive FCC limit for exposures of unlimited duration to radio frequency energy for several personal wireless services are as follows:

Wireless Service	Frequency Band	Occupational Limit	Public Limit
Microwave (Point-to-Point)	5,000–80,000 MHz	5.00 mW/cm ²	1.00 mW/cm ²
BRS (Broadband Radio)	2,600	5.00	1.00
AWS (Advanced Wireless)	2,100	5.00	1.00
PCS (Personal Communication)	1,950	5.00	1.00
Cellular	870	2.90	0.58
SMR (Specialized Mobile Radio)	855	2.85	0.57
700 MHz	700	2.35	0.47
[most restrictive frequency range]	30–300	1.00	0.20

Power line frequencies (60 Hz) are well below the applicable range of these standards, and there is considered to be no compounding effect from simultaneous exposure to power line and radio frequency fields.

General Facility Requirements

Base stations typically consist of two distinct parts: the electronic transceivers (also called “radios” or “channels”) that are connected to the traditional wired telephone lines, and the passive antennas that send the wireless signals created by the radios out to be received by individual subscriber units. The transceivers are often located at ground level and are connected to the antennas by coaxial cables.

**ExteNet Systems CA, LLC • Proposed DAS Node (Site No. 06089B)
1700 Seminary Avenue • Oakland, California**

A small antenna for reception of GPS signals is also required, mounted with a clear view of the sky. Because of the short wavelength of the frequencies assigned by the FCC for wireless services, the antennas require line-of-sight paths for their signals to propagate well and so are installed at some height above ground. The antennas are designed to concentrate their energy toward the horizon, with very little energy wasted toward the sky or the ground. This means that it is generally not possible for exposure conditions to approach the maximum permissible exposure limits without being physically very near the antennas.

Computer Modeling Method

The FCC provides direction for determining compliance in its Office of Engineering and Technology Bulletin No. 65, “Evaluating Compliance with FCC-Specified Guidelines for Human Exposure to Radio Frequency Radiation,” dated August 1997. Figure 2 attached describes the calculation methodologies, reflecting the facts that a directional antenna’s radiation pattern is not fully formed at locations very close by (the “near-field” effect) and that at greater distances the power level from an energy source decreases with the square of the distance from it (the “inverse square law”). The conservative nature of this method for evaluating exposure conditions has been verified by numerous field tests.

Site and Facility Description

Based upon information provided by ExteNet, including drawings by Black & Veatch Corporation, dated September 20, 2016, it is proposed to install one CommScope Model 3X-V65S-GC3-3XR, 2-foot tall, tri-directional cylindrical antenna, with two directions activated, on a cross-arm to be added to a utility pole sited in the public right-of-way in front of the two-story building located at 1700 Seminary Avenue in Oakland. The antenna would employ no downtilt, would be mounted at an effective height of about 20 feet above ground, and its principal directions would be oriented toward 30°T and 150°T. T-Mobile proposes to operate from this facility with a maximum effective radiated power in any direction of 122 watts, representing simultaneous operation at 61 watts for AWS and 61 watts for PCS service. There are reported no other wireless telecommunications base stations at this site or nearby.

Study Results

For a person anywhere at ground, the maximum RF exposure level due to the proposed T-Mobile operation is calculated to be 0.0026 mW/cm², which is 0.26% of the applicable public exposure limit. The maximum calculated level at the second-floor elevation of any nearby building is 5.0% of the public exposure limit. It should be noted that these results include several “worst-case” assumptions and therefore are expected to overstate actual power density levels from the proposed operation.

**ExteNet Systems CA, LLC • Proposed DAS Node (Site No. 06089B)
1700 Seminary Avenue • Oakland, California**

Recommended Mitigation Measures

Due to its mounting location and height, the ExteNet antenna would not be accessible to the general public, and so no mitigation measures are necessary to comply with the FCC public exposure guidelines. To prevent occupational exposures in excess of the FCC guidelines, it is recommended that appropriate RF safety training be provided to all authorized personnel who have access to the antenna, including employees and contractors of the utility companies. No access within 1 foot directly in front of the antenna itself, such as might occur during certain activities, should be allowed while the base station is in operation, unless other measures can be demonstrated to ensure that occupational protection requirements are met. Posting explanatory signs* on the pole at or below the antenna, such that the signs would be readily visible from any angle of approach to persons who might need to work within that distance, would be sufficient to meet FCC-adopted guidelines.

Conclusion

Based on the information and analysis above, it is the undersigned's professional opinion that operation of the node proposed by ExteNet Systems CA, LLC, at 1700 Seminary Avenue in Oakland, California, will comply with the prevailing standards for limiting public exposure to radio frequency energy and, therefore, will not for this reason cause a significant impact on the environment. The highest calculated level in publicly accessible areas is much less than the prevailing standards allow for exposures of unlimited duration. This finding is consistent with measurements of actual exposure conditions taken at other operating base stations. Training personnel and posting signs is recommended to establish compliance with occupational exposure limitations.

Authorship

The undersigned author of this statement is a qualified Professional Engineer, holding California Registration No. E-18063, which expires on June 30, 2017. This work has been carried out under his direction, and all statements are true and correct of his own knowledge except, where noted, when data has been supplied by others, which data he believes to be correct.

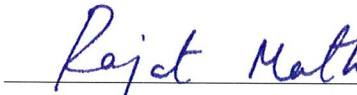
Rajat Mathur, P.E.
707/996-5200

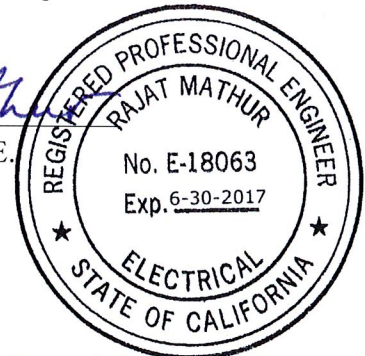

October 5, 2016

* Signs should comply with OET-65 color, symbol, and content recommendations. Contact information should be provided (e.g., a telephone number) to arrange for access to restricted areas. The selection of language(s) is not an engineering matter, and guidance from the landlord, local zoning or health authority, or appropriate professionals may be required. Signage may also need to comply with the requirements of California Public Utilities Commission General Order No. 95.



FCC Radio Frequency Protection Guide

The U.S. Congress required (1996 Telecom Act) the Federal Communications Commission (“FCC”) to adopt a nationwide human exposure standard to ensure that its licensees do not, cumulatively, have a significant impact on the environment. The FCC adopted the limits from Report No. 86, “Biological Effects and Exposure Criteria for Radiofrequency Electromagnetic Fields,” published in 1986 by the Congressionally chartered National Council on Radiation Protection and Measurements (“NCRP”). Separate limits apply for occupational and public exposure conditions, with the latter limits generally five times more restrictive. The more recent standard, developed by the Institute of Electrical and Electronics Engineers and approved as American National Standard ANSI/IEEE C95.1-2006, “Safety Levels with Respect to Human Exposure to Radio Frequency Electromagnetic Fields, 3 kHz to 300 GHz,” includes similar limits. These limits apply for continuous exposures from all sources and are intended to provide a prudent margin of safety for all persons, regardless of age, gender, size, or health.

As shown in the table and chart below, separate limits apply for occupational and public exposure conditions, with the latter limits (in *italics* and/or dashed) up to five times more restrictive:

Frequency Applicable Range (MHz)	Electromagnetic Fields (f is frequency of emission in MHz)					
	Electric Field Strength (V/m)		Magnetic Field Strength (A/m)		Equivalent Far-Field Power Density (mW/cm ²)	
0.3 – 1.34	614	<i>614</i>	1.63	<i>1.63</i>	100	<i>100</i>
1.34 – 3.0	614	<i>823.8/f</i>	1.63	<i>2.19/f</i>	100	<i>180/f²</i>
3.0 – 30	1842/f	<i>823.8/f</i>	4.89/f	<i>2.19/f</i>	900/f ²	<i>180/f²</i>
30 – 300	61.4	<i>27.5</i>	0.163	<i>0.0729</i>	1.0	<i>0.2</i>
300 – 1,500	3.54√f	<i>1.59√f</i>	√f/106	<i>√f/238</i>	f/300	<i>f/1500</i>
1,500 – 100,000	137	<i>61.4</i>	0.364	<i>0.163</i>	5.0	<i>1.0</i>

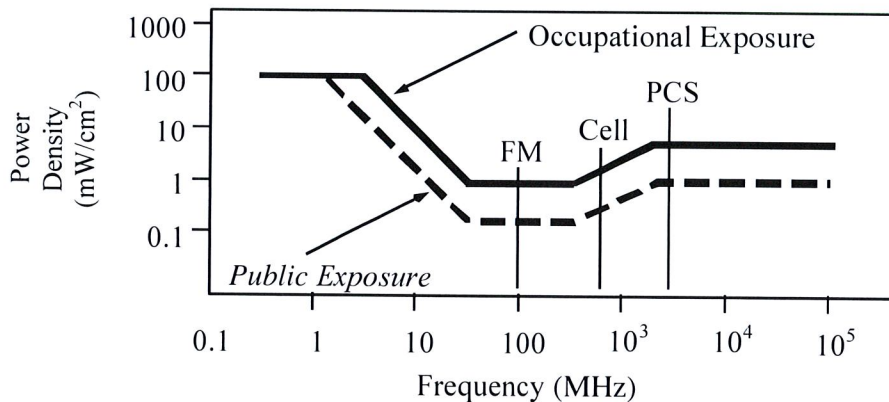

Higher levels are allowed for short periods of time, such that total exposure levels averaged over six or thirty minutes, for occupational or public settings, respectively, do not exceed the limits, and higher levels also are allowed for exposures to small areas, such that the spatially averaged levels do not exceed the limits. However, neither of these allowances is incorporated in the conservative calculation formulas in the FCC Office of Engineering and Technology Bulletin No. 65 (August 1997) for projecting field levels. Hammett & Edison has built those formulas into a proprietary program that calculates, at each location on an arbitrary rectangular grid, the total expected power density from any number of individual radio sources. The program allows for the description of buildings and uneven terrain, if required to obtain more accurate projections.

RFR.CALC™ Calculation Methodology

Assessment by Calculation of Compliance with FCC Exposure Guidelines

The U.S. Congress required (1996 Telecom Act) the Federal Communications Commission (“FCC”) to adopt a nationwide human exposure standard to ensure that its licensees do not, cumulatively, have a significant impact on the environment. The maximum permissible exposure limits adopted by the FCC (see Figure 1) apply for continuous exposures from all sources and are intended to provide a prudent margin of safety for all persons, regardless of age, gender, size, or health. Higher levels are allowed for short periods of time, such that total exposure levels averaged over six or thirty minutes, for occupational or public settings, respectively, do not exceed the limits.

Near Field.

Prediction methods have been developed for the near field zone of panel (directional) and whip (omnidirectional) antennas, typical at wireless telecommunications base stations, as well as dish (aperture) antennas, typically used for microwave links. The antenna patterns are not fully formed in the near field at these antennas, and the FCC Office of Engineering and Technology Bulletin No. 65 (August 1997) gives suitable formulas for calculating power density within such zones.

For a panel or whip antenna, power density $S = \frac{180}{\theta_{BW}} \times \frac{0.1 \times P_{net}}{\pi \times D \times h}$, in mW/cm²,

and for an aperture antenna, maximum power density $S_{max} = \frac{0.1 \times 16 \times \eta \times P_{net}}{\pi \times h^2}$, in mW/cm²,

where θ_{BW} = half-power beamwidth of the antenna, in degrees, and

P_{net} = net power input to the antenna, in watts,

D = distance from antenna, in meters,

h = aperture height of the antenna, in meters, and

η = aperture efficiency (unitless, typically 0.5-0.8).

The factor of 0.1 in the numerators converts to the desired units of power density.

Far Field.

OET-65 gives this formula for calculating power density in the far field of an individual RF source:

power density $S = \frac{2.56 \times 1.64 \times 100 \times RFF^2 \times ERP}{4 \times \pi \times D^2}$, in mW/cm²,

where ERP = total ERP (all polarizations), in kilowatts,

RFF = relative field factor at the direction to the actual point of calculation, and

D = distance from the center of radiation to the point of calculation, in meters.

The factor of 2.56 accounts for the increase in power density due to ground reflection, assuming a reflection coefficient of 1.6 (1.6 x 1.6 = 2.56). The factor of 1.64 is the gain of a half-wave dipole relative to an isotropic radiator. The factor of 100 in the numerator converts to the desired units of power density. This formula has been built into a proprietary program that calculates, at each location on an arbitrary rectangular grid, the total expected power density from any number of individual radiation sources. The program also allows for the description of uneven terrain in the vicinity, to obtain more accurate projections.





November 30, 2016

City Planner
Planning Department
City of Oakland
250 Frank H. Ogawa Plaza, 2nd Floor
Oakland, CA 94612

Re: GO 95 Required Two Feet Clearance Between Antenna and Pole
Applicant: ExteNet Systems (California) LLC
Nearest Site Address: Public Right of Way near 1701 39th Avenue
Site ID: NW-CA-SANFRNMC-TMO Node 06012B
Latitude/Longitude: 37.776334, -122.217555

Dear City Planner,

This letter is in response to discussions with City of Oakland Planning Department seeking clarification on the proposed antenna placement on the utility pole.

Wireless facility attachments to utility poles must comply with CPUC General Order 95 design, safety and clearance standards. Specifically, Rule 94.4(B) states: *Antennas shall maintain a 2 ft horizontal clearance from centerline of pole when affixed between supply and communication lines or below communication lines.* This rule precludes ExteNet from placing the antennas flush mounted to the utility pole when there is a power source attached to the pole. ExteNet minimized the clearance as much as possible by placing the antenna shroud just over two feet from the centerline of the utility pole.

Feel free to contact me if you have any questions. Thank you.

Thank you.

Best Regards,

Ana Gomez/BV for ExteNet

Ana Gomez
ExteneNet Permitting Contractor

NO PARKING
12:00 AM TO
3:00 AM
TUES THUR SAT
EACH MONTH
STREET SWEEPING

LA RAZA
MARKET #2

ATTACHMENT H