

Appendix A
**Notice of Preparation and
Summary of Comments**

Summary of Environmental Topics Raised In Response to the Notice of Preparation and During the Community Input Process

The following CEQA topics were among those that were raised in written comments received in response to the NOP for this SEIR (see Appendix A), and include comments stated during the City’s scoping meetings held by the Oakland Planning Commission.¹ Each of these CEQA topics is addressed in this SEIR. Comments that raised non-CEQA topics or are that are not pertinent to the CEQA analysis of the Project Modifications are noted but not addressed directly in this SEIR. Issued addressed in the public comments and relevant to the CEQA analysis of the Project Modifications generally include:

- New shading on solar arrays, public open spaces
- Public views of the Estuary, the Bay and shoreline including BCDC permit conditions
- Water turbulence and other effects on wildlife, wetlands, and other biological resources
- Wave frequency and adequate sediment supply
- Effects on protected bird species including from new lighting
- Cumulative impacts on biological resources
- Land Use Consistency with the Estuary Policy Plan
- Recreational Resources
- Water Supply Assessment
- Sea Level Rise (for informational purposes)

¹ Copies of NOP comment letters and minutes of the Public Scoping Meetings held on October 17, 2018 and November 7, 2018 are available for review at the City of Oakland Bureau of Planning, 250 Frank H. Ogawa Plaza.

This page intentionally left blank



CITY OF OAKLAND

Bureau of Planning

250 Frank H. Ogawa Plaza, Suite 3315, Oakland, California, 94612-2032

NOTICE OF PREPARATION (NOP) OF A SUPPLEMENTAL ENVIRONMENTAL IMPACT REPORT (SEIR) FOR THE BROOKLYN BASIN (“FORMERLY OAK TO NINTH MIXED USE DEVELOPMENT”) PROJECT

The City of Oakland’s Bureau of Planning is preparing a Draft Supplemental Environmental Impact Report (“SEIR”) for proposed modifications to the Oak to Ninth Mixed Use Development analyzed in the 2006 EIR and 2009 Recertified EIR prepared and published by the City of Oakland (City), and subsequently renamed and approved as the Brooklyn Basin Project, which is comprised of the Brooklyn Basin Planned Unit Development (PUD) and referred to herein as “approved project.” The City is requesting comments on the scope and content of the Draft SEIR. The City has **not** prepared an Initial Study; the Draft SEIR will address the potential environmental effects of the modifications to the approved project per the requirements of the California Environmental Quality Act (CEQA) statutes (Public Resources Code [PRC] Section 21000 et seq.) and the CEQA Guidelines (California Code of Regulations 15000 et seq.).

The City of Oakland is the Lead Agency for the project and is the public agency with the greatest responsibility for considering approval of the project and/or carrying it out. This notice is being sent to Responsible Agencies and other interested parties. Responsible Agencies are those public agencies, besides the City of Oakland, that have a role in considering approval and/or carrying out the project. When the Draft SEIR is published, it will be sent to all Responsible Agencies and to others who respond to this NOP or who otherwise indicate that they would like to receive a copy.

Responses to this NOP that address the scope of the Draft SEIR and any related questions or comments should be directed in writing to: **Catherine Payne, Acting Development Planning Manager, City of Oakland Bureau of Planning, 250 Frank H. Ogawa Plaza, Suite 2214, Oakland, CA 94612; (510) 238-6168 (phone); (510) 238-3254 (fax); or cpayne@oaklandca.gov.** Responses to the NOP must be received at the above mailing or e-mail address by 5:00 p.m. on **October 22, 2018**. Please reference Case File Number **PUD06010-R02-ER01** in all correspondence. In addition, comments on the scope of the Draft SEIR will be received at the SEIR Scoping Meetings to be held before the City Planning Commission, as noticed below.

The proposed modifications to the approved project are described in greater detail below. Commenters should focus comments on potential impacts of the proposed modifications to the approved project on the physical environment; ways in which potential adverse effects resulting from the modifications to the approved project might be minimized; and alternatives to the project with the proposed modifications, in light of the Revised SEIR’s purpose to provide useful and accurate information about such factors.

To the extent that public comments received on the scope and adequacy of the 2009 Recertified EIR apply to the modified project, the City will continue to consider such comments during the preparation of the Revised Draft SEIR.

EIR SCOPING MEETING:

The **City of Oakland Planning Commission** will conduct a public scoping meeting on the Draft SEIR for modifications to the Brooklyn Basin Project on **October 17, 2018 at 6:00 p.m.** in the Oakland City Council Chamber in **Oakland City Hall, 1 Frank H. Ogawa Plaza, Oakland, CA.**

PROJECT TITLE: Brooklyn Basin Project (Case File No. PUD06010-R02-ER01; State Clearinghouse Number: 20062013)

PROJECT LOCATION: Approximately 64.2 land acres bound by Embarcadero Road (north), the Oakland Estuary (south), Fallon Street (west), and approximately 10th Avenue (east), in addition to 8 acres of submerged land (see **Figure 1**). Assessor Parcel Numbers include 0000-0430-001-02, portion of 0000-0430-001-04, 0000-0460-003, 0000-0460-004, 0000-0465-002, and a portion of 0000-0470-002.

PROJECT SPONSOR: Zarsion-OHP 1, LLC

EXISTING CONDITIONS: The site currently has City of Oakland General Plan designations of Planned Waterfront Development-1 (PWD-4) in the Estuary Policy Plan, and in the Planned Waterfront Zoning District (PWD-4). As of the date of this NOP, the project site is not included in the list of Hazardous Waste and Substances sites in the Department of Toxic Substances Control (DTSC) EnviroStor database, one of the lists meeting the “Cortese List” requirements (<http://www.calepa.ca.gov/sitecleanup/corteselist/>, accessed September 4, 2018).

The project was originally approved in five phases: Phases I-IV and Phase Ia, see **Figure 2**. Final Development Plans for Phases I and II construction, including Parcels B, C and F vertical development, have been approved. Construction of Phases I and II has already commenced, including work on the Phase I landside components (Shoreline Park, 9th Avenue Terminal Building) and Phase II site remediation of the project are underway. Notable changes to existing site conditions since publication of the 2009 Recertified EIR and potentially relevant to the CEQA analysis of the proposed modifications include demolition of previous structure, site remediation, site grading, Embarcadero improvements (bridge construction, established bike lanes), the aforementioned Phase I landside development, including approval of an affordable housing project—the vertical development approved for Parcel F.

BACKGROUND: The City certified an EIR for the project in 2006. That EIR was subsequently modified to comply with the Alameda County Superior Court ruling to rescind its 2006 certification and revise the EIR, which the City subsequently recertified in 2009. The approved Brooklyn Basin Project analyzed in the 2006 and 2009 EIRs (referred to collectively as “EIR”) involves development of 3,100 residential units, 200,000 square feet of ground-floor retail/commercial and civic spaces, 29.9 acres of parks and public open space, an existing wetlands restoration area, and improvements and expansion of Clinton Basin marina, see **Figure 3**.

Because an EIR was already recertified for the project, the City is required to determine whether further CEQA environmental review is required for the proposed modifications to the approved project in accordance with PRC Section 21166 and CEQA Guidelines Section 15162. Under these sections, no further environmental review is required unless there are new or substantially more severe impacts of the project than those analyzed in the certified EIR. Because the proposed modifications to the project may result in new and potentially substantially more severe impacts than the original project analyzed in the EIR, the City of Oakland is resuming the CEQA analysis by preparing a SEIR for the modifications.

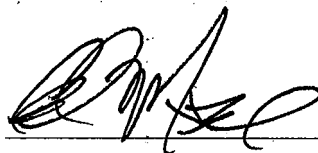
PROJECT DESCRIPTION:

Additional Residential Units: The Project sponsor seeks to amend Phases III and IV of the approved project to allow an additional 600 residential units, for a total of up to 3,700 units. (Phase Ia, the remediation of Estuary Park, would be unaffected.) The modifications proposed to the approved project would accommodate the additional units within the approved building envelopes; no changes to the height, massing or setbacks of the approve project are required or proposed. As anticipated in the original PUD, the allocation of residential units has shifted between certain development parcels since approval of the project, however the current allocation of units on each parcel still results in a total of 3,100 units on the overall project site. It is anticipated that the additional 600 units would be located in Parcels K, L, and M to be developed in project Phases III and IV (of the five phases total), see **Figure 4**. The Project sponsor also seeks amendments to allow the right to relocate one of the approved residential towers, currently contemplated on Parcels H and J, to either Parcel L or Parcel M (resulting in two towers sited on Parcel M). To accommodate the increased density resulting with the modifications to the project, the Project sponsor seeks to amend the General Plan to modify the existing PWD-4 land use classification, and seeks a Zoning Code Amendment to amend the average density of the PWD-4 Zoning District and to increase the total number of units allowed from 3,100 to 3,700. This aspect of the proposed modifications also requires approval of a revised PUD permit and an amendment to the approved Development Agreement (DA) between the Project sponsor and the City.

Marina Expansion: The Project sponsor also seeks to modify the approved project to expand the Brooklyn Basin marina in Clinton Basin to a total 218 slips. The original PUD had approved a total 60 slips in Clinton Basin, therefore the proposed modifications would result in an increase of up to 158 slips compared to the approved project, see Figure 5. The modification would remove and replace the existing Clinton Basin marina, expanding it with 14 additional docks that would wrap along the shoreline between 9th Avenue into Clinton Basin. No changes are proposed to the previously approved upland development, except for main walkway improvements near the 9th Avenue Terminal Building, and a harbor master office, laundry facilities and boater parking in compliance with the Clean Marina Program. Marina restroom facilities would be located on the ground floor of an approved building fronting Clinton Basin. The modifications to the marina plan would shade or "fill" approximately 114,375 square feet over open water compared to approximately 23,460 square feet of fill previously analyzed; therefore, the modification will result in a net increase of approximately 90,915 square feet the area of fill compared to the original project. No fuel station would be introduced. This proposed marina expansion also requires approval of a revised PUD, a previously approved Final Development Plan, a new conditional use permit as well as a DA amendment.

Landing Dock for Ferry I Water Taxi Service: The modification to the project also proposes to develop a landing dock at the Brooklyn Basin marina to accommodate an existing water taxi and small-scale ferry service. Initially, the landing dock would be served by limited service, available to project residents and the public, with a service to the San Francisco Ferry Building (Gate B).

ENVIRONMENTAL TOPICS: The following topics will be fully addressed in the Draft SEIR: *aesthetics, air quality and health risk, biological resources, cultural and tribal cultural resources, greenhouse gas emissions, hydrology and water quality, land use and planning, noise and vibration, transportation and traffic, and utilities and service systems.* The following topics will be addressed briefly in the Draft SEIR, to the extent necessary to assess whether the proposed modifications to the approved project would have new or substantially more severe impacts on these topics identified in the certified EIR: *agriculture and forestry resources, hazards and hazardous materials, mineral resources, population and housing, and public services and recreation.* The Draft SEIR will also examine a reasonable range of alternatives to the proposed modifications. The analysis will consider each of the alternatives analyzed in the 2009 EIR, as well as the CEQA-mandated No Project Alternative and other potential alternatives that may reduce or avoid potential environmental effects.

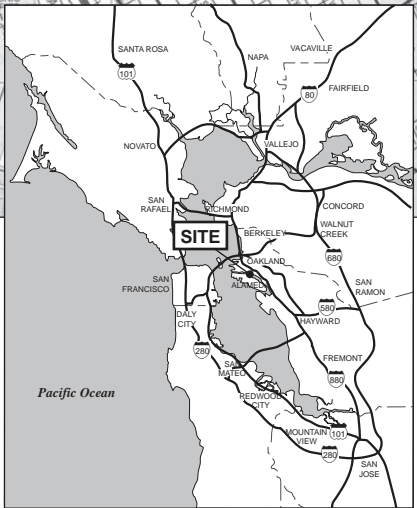


September 21, 2018
Case File Number: PUD06010-R02-ER01

Interim Deputy Planning Director, Bureau of Planning
Environmental Review Officer

Attachments:

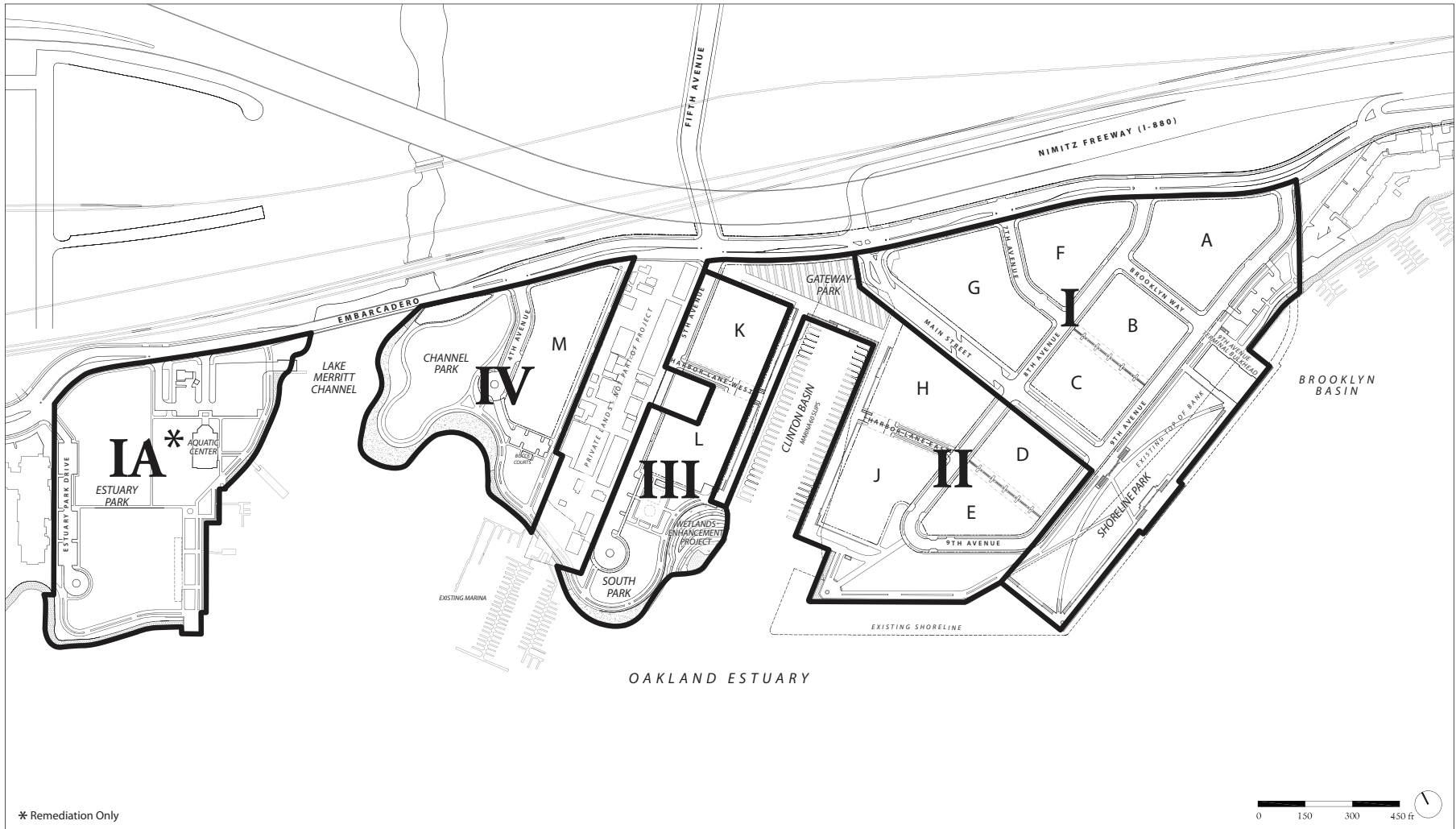
- Figure 1, Location Map
- Figure 2, Phasing Plan, dated 2006 (approved 2009)
- Figure 3, Illustrative Development Plan (PUD), dated 2006 (approved 2009, amended 2014)
- Figure 4a, Approved Development Program and Parcelization Plan, dated 2006 (approved 2009)
- Figure 4b, Approved Enlarged Plan—Clinton Basin Quays, dated 2006 (approved 2009)
- Figure 5, Proposed Modification to the Illustrative Development Plan (PUD), dated 2018



SOURCE: ESA

Brooklyn Basin Project 150431

Figure 1
Location Map



A-7

* Remediation Only

PHASING PLAN

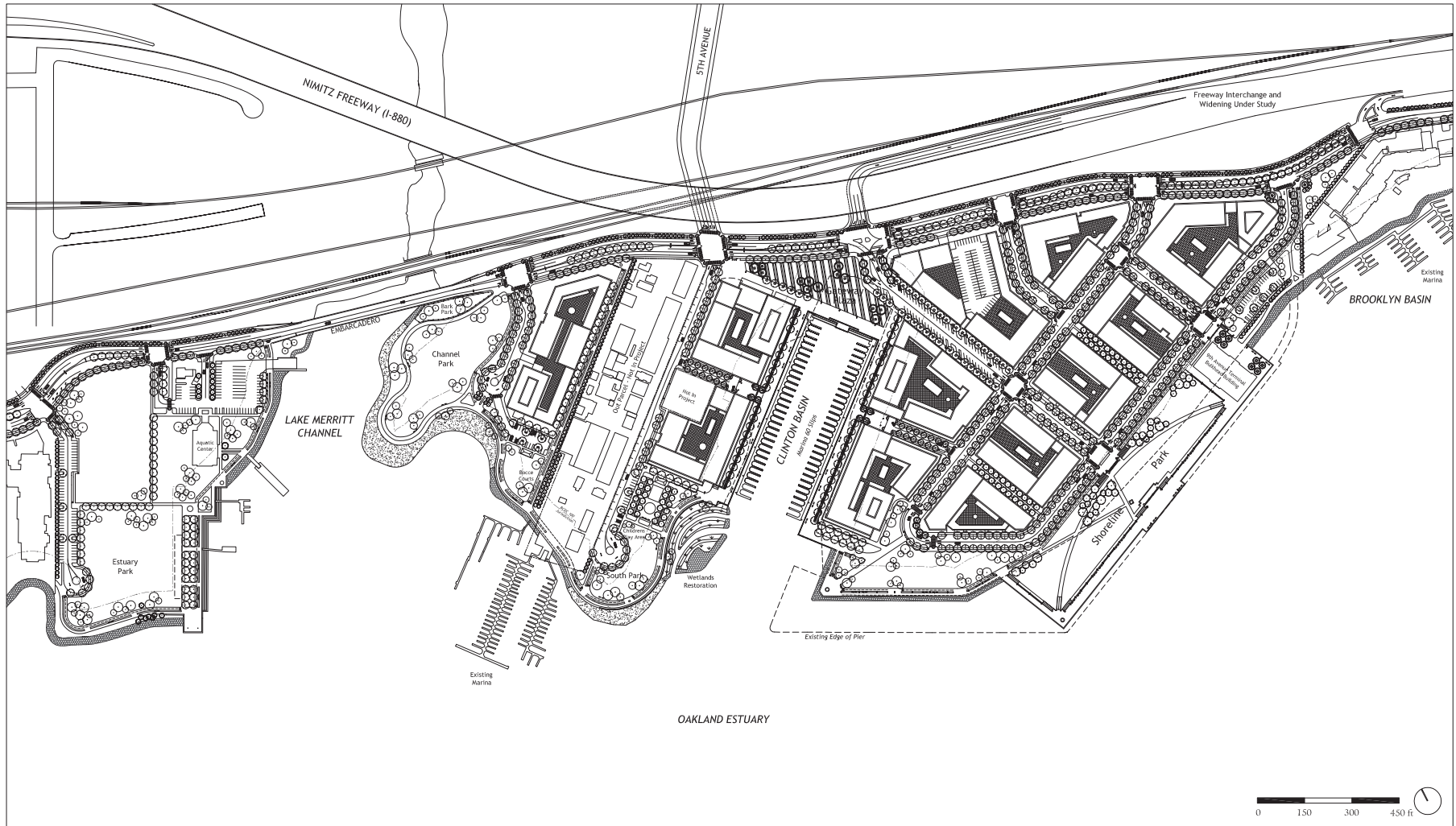
Brooklyn Basin - Oak to 9th Development Plan

Prepared for Oakland Harbor Partners by ROMA Design Group in association with MVE Architects, Moffatt & Nichol and BKF Engineers

OCTOBER 2006

Figure 2

SHEET NO.
1.5



A-8

ILLUSTRATIVE DEVELOPMENT PLAN

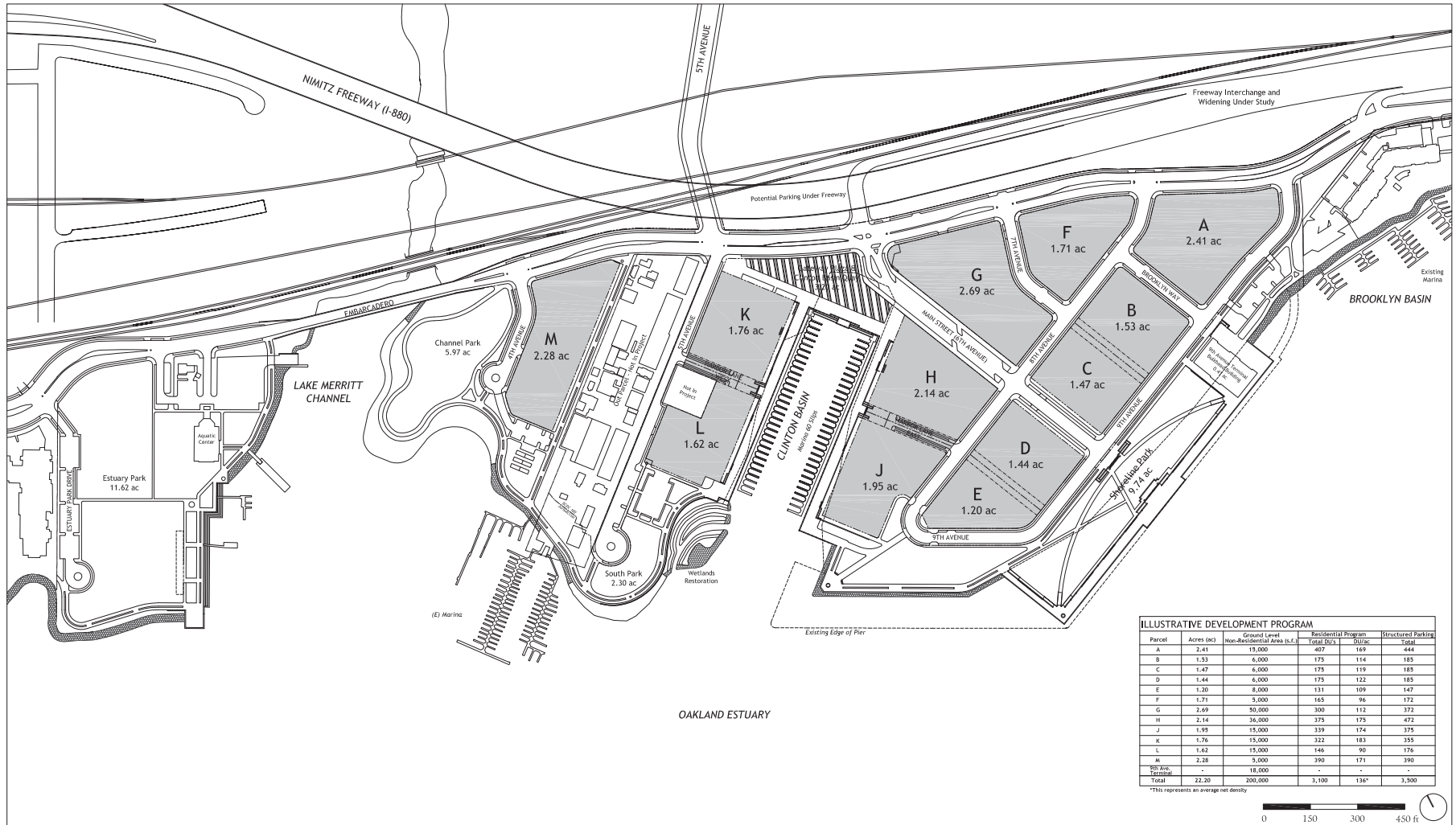
Brooklyn Basin - Oak to 9th Development Plan

Prepared for Oakland Harbor Partners by ROMA Design Group in association with MVE Architects, Moffatt & Nichol and BKF Engineers

OCTOBER 2006

Figure 3

SHEET NO.
1.3



ILLUSTRATIVE DEVELOPMENT PROGRAM					
Parcel	Acres (ac)	Ground Level		Structured Parking	
		Non-Residential Area (s.f.)	Residential Program Total DUs	Structure	Total
A	2.41	19,000	407	169	444
B	1.53	6,000	175	114	185
C	1.47	6,000	175	119	185
D	1.44	6,000	175	122	185
E	1.20	8,000	131	109	147
F	1.71	5,000	165	96	172
G	2.69	50,000	300	112	372
H	2.14	36,000	375	175	472
J	1.95	15,000	339	174	375
K	1.76	15,000	322	183	355
L	1.62	15,000	146	90	176
M	2.28	3,000	390	171	390
City Ave. Terminus	-	18,000	-	-	-
Total	22.20	200,000	3,100	136*	3,300

*This represents an average net density

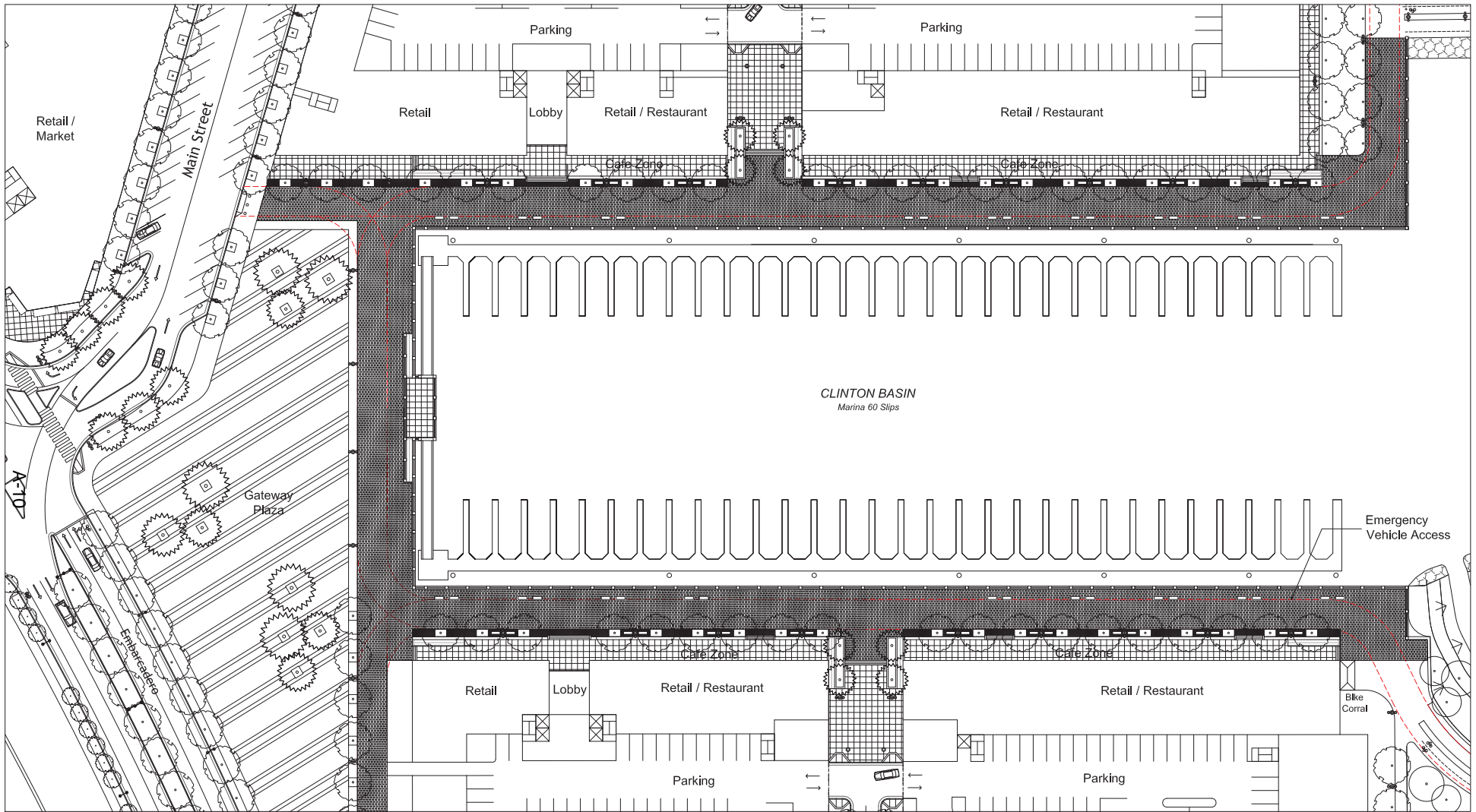
DEVELOPMENT PROGRAM AND PARCELIZATION PLAN

Brooklyn Basin - Oak to 9th Development Plan

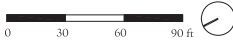
Prepared for Oakland Harbor Partners by ROMA Design Group in association with MVE Architects, Moffatt & Nichol and BKF Engineers

OCTOBER 2006

Figure 4a SHEET NO. 1.4



ENLARGED PLAN - CLINTON BASIN QUAYS



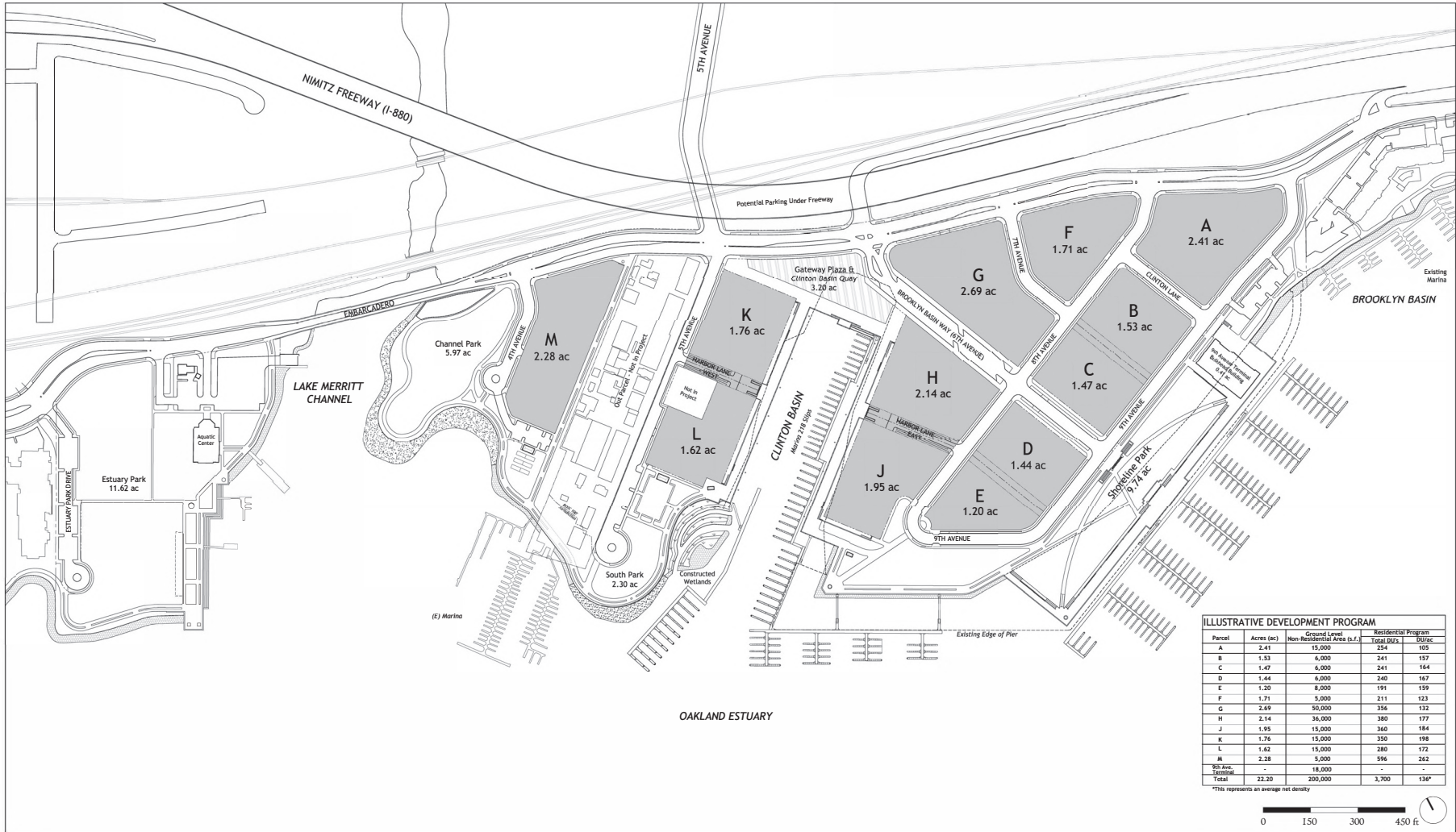
Brooklyn Basin - Oak to 9th Development Plan

Prepared for Oakland Harbor Partners by ROMA Design Group in association with MVE Architects, Moffatt & Nichol and BKF Engineers

OCTOBER 2006

Figure 4b

SHEET NO.
3.7a



A-11

DEVELOPMENT PROGRAM AND PARCELIZATION PLAN

Brooklyn Basin - Oak to 9th Development Plan

Prepared for Oakland Harbor Partners by ROMA Design Group in association with MVE Architects, Moffatt & Nichol and BKF Engineers

AMENDED NOVEMBER 5, 2014

PROPOSED MARCH 2018 AMENDMENT

Figure 5

SHEET NO. 1.4

Appendix B
**Oakland Major Project
List**

Brooklyn Basin Parcel J	845 Embarcadero	Oakland Waterfront Parcel J, LLC	Anh Le	(310)566-8700	ale@cityview.com	PUD06010-PUDF11	Brooklyn Basin	8	378						2700			Dara O'Byrne	dobyne@oaklandca.gov	(510)238-6983	6/17/2019	12/18/2019
Brooklyn Basin Parcel A	101 Ninth Ave	MidPen Housing	Jennifer Liu	(510)426-5672	jliu@midpen-housing.org	PUD06010-PUDF12	Brooklyn Basin	6									120864	Dara O'Byrne	dobyne@oaklandca.gov	(510)238-6983	11/19/2018	6/5/2019
Site B	012 102501100, 012 102501200	Boston Properties	Aaron Fenton	(415)772-0714	afenton@bostonproperties.com	PUD06058-R01-PUDF01		24	357	45	254							Catherine Payne	cpayne@oaklandca.gov	(510)238-6168	2016	2017
Fruitvale Phase IIA	0 30th Ave	EBALDC/Unity Council	Everett Cleveland	(510)287-5353	ecleveland@ebaldc.com	PUD08186-PUDF01	Fruitvale	4				94						Rebecca Lind	rlind@oaklandca.gov	(510)238-3472	2/13/2015	5/6/2015
Fruitvale Phase IIB	0 35th Ave	Bridge Housing/Unity Council	Ethan Warsh	(415)485-3591	ewarsh@bridgehousing.com	PUD08186-PUDF02		7	2	10	94	66		6000				Rebecca Lind	rlind@oaklandca.gov	(510)238-3472	8/27/2018	11/28/2018
Kaiser Center Office - PUD REV	300 Lakeside	Swig Company	Tomas Schoenberg	(415)291-1100	tschoenberg@swigco.com	PUD103-R01	Downtown	15-40	580						1360500			Pete Vollmann	pvollmann@oaklandca.gov	(510)238-6167	10/5/2018	10/16/2019
Site C	018 041000105 (10 Clay)	Ellis Partners	Dean Rubinson	(415)391-9800	dean@ellispartners.com	PUD13170		2						15000	15000			Catherine Payne	cpayne@oaklandca.gov	(510)238-6168	2006	2007
Site F1	018 04200402	CIM Group	Sean Buran	(323)860-1811	sburan@cimgroup.com	PUD13170								250000				Catherine Payne	cpayne@oaklandca.gov	(510)238-6168	2008	2008
Site G	001 015105200	CIM Group	Sean Buran	(323)860-1811	sburan@cimgroup.com	PUD13170		7							30000		PUD parking	Catherine Payne	cpayne@oaklandca.gov	(510)238-6168	2007	2009
Site D	018 041500101	CIM Group	Sean Buran	(323)860-1811	sburan@cimgroup.com	PUD13170-PUDF01		8	135									Catherine Payne	cpayne@oaklandca.gov	(510)238-6168	2017	2017
Site F2	018 04200401	CIM Group	Sean Buran	(323)860-1811	sburan@cimgroup.com	PUD13170-PUDF02		8	338									Catherine Payne	cpayne@oaklandca.gov	(510)238-6168	2017	2017
Site F3	018 04200402	CIM Group	Sean Buran	(323)860-1811	sburan@cimgroup.com	PUD13170-PUDF03											155-key hotel	Catherine Payne	cpayne@oaklandca.gov	(510)238-6168	2017	
T5/6	002 009704000	Strada	William Goodman	(314)276-0707	wgoodman@stradasf.com	PUD99215		14	262						5000			Catherine Payne	cpayne@oaklandca.gov	(510)238-6168	2014	2015
Site A1	012 102501001	Hines	Kevin Chow	(415)399-6221	kevin.chow@hines.com	PUDF08		8	278		8				22000			Catherine Payne	cpayne@oaklandca.gov	(510)238-6168	2014	2015
Site C	012 102501300	Hines	Kevin Chow	(415)399-6221	kevin.chow@hines.com	PUDF08		8	89		4							Catherine Payne	cpayne@oaklandca.gov	(510)238-6168	2014	2015
T12	002 002700700	Shorenstein	Todd Sklar	(415)772-7069	tsklar@shorenstein.com	PUDF10		24						600000	10000			Catherine Payne	cpayne@oaklandca.gov	(510)238-6168	2015	2016
BART Garage	012 102500600	MTCP	Marie Debor	(415)989-1111	mdebor@bridgehousing.com	PUDF10097		6									480 pkg	Catherine Payne	cpayne@oaklandca.gov	(510)238-6168	2010	2011
Site D Affordable	012 102500500	MTCP	Marie Debor	(415)989-1111	mdebor@bridgehousing.com	PUDF10322		5			90							Catherine Payne	cpayne@oaklandca.gov	(510)238-6168	2010	2011
2 Kaiser Plaza	325 22nd Street	CIM Group	Sean Buran	(323)860-1811	sburan@cimgroup.com	ZP160061		33						800000	11000			Catherine Payne	cpayne@oaklandca.gov	(510)238-6168	2015	2018
Pigozzi	460 24th St	Signature Development	Jamie Choy	(510)251-9276	jchoy@signaturedevelopment.com	ZP180025	25th Street Garage District API	6						86100	11980			Rebecca Lind	rlind@oaklandca.gov	(510)238-3472	3/5/2018	
California College of the Arts	5215 Broadway	Arts Campus Holdings, LLC	Marc Babson	(415)723-9561	marcb@emeraldfund.com	ZP180116	California College District API	4-8	534		35						34280	Rebecca Lind	rlind@oaklandca.gov	(510)238-3472	11/30/2018	
Oakland Museum of CA	1000 Oak St	OMCA	Lori Fogarty	(510)318-8420	lfogarty@museumca.org	ZP180120	Lake Merritt	2										Mike Rivera	mriviera@oaklandca.gov	(510)238-6417	12/10/2018	12/21/2018
Oakland Museum of CA	1000 Oak St	OMCA	Lori Fogarty	(510)318-8420	lfogarty@museumca.org	ZP180120	Lake Merritt	2										Mike Rivera	mriviera@oaklandca.gov	(510)238-6417	12/10/2018	12/21/2018
600 Castro	600 Castro St	Frank Yang	Frank Yang	(510)648-4906	frankyang@gmail.com	ZP190058	Downtown	8	373	TBD	TBD	TBD		11,500				Rebecca Lind	rlind@oaklandca.gov	(510)238-3472	5/23/2019	
415 20th St	415 20th St	Hines	Kevin Chow	(415) 399-6800	kevin.chow@hines.com	ZP190087	Downtown	41						903100				Rebecca Lind	rlind@oaklandca.gov	(510)238-3472	7/31/2019	
1515 Market St	1515 Market St	Pytock Architects	Peter Waller	(510)465-7010	pwaller@pytock.com	ZP190102		TBD	TBD	TBD	TBD	TBD						Rebecca Lind	rlind@oaklandca.gov	(510)238-3472	9/26/2019	
1431 Franklin	1431 Franklin	Tidewater Capital	Kyle Winkler	(510) 290-9901	kwinkler@tidewatercap.com	ZP190117	Downtown	29	314	TBD	TBD	TBD						Rebecca Lind	rlind@oaklandca.gov	(510)238-3472	11/4/2019	

Appendix C
**Transportation Impact Review
(non-CEQA)**



MEMORANDUM

Date: May 11, 2021
To: Elizabeth Kanner, ESA
From: Rob Rees, Chris Wahl, and Sam Inoue-Alexander, Fehr & Peers
Subject: **Brooklyn Basin Density Increase – Transportation Impact Review (non-CEQA)**

OK18-0295.00

This memorandum summarizes the non-CEQA transportation assessment Fehr & Peers completed for the proposed Brooklyn Basin Marina Expansion Project (Project Modification) in Oakland, and includes additional analysis requested by the City of Oakland while reviewing the 1st Administrative Draft of the Project Modification SEIR. This memorandum uses the following project definitions to provide consistency and clarity in documentation:

- **Approved Project:** The Brooklyn Basin project site plan and land use as defined in the approved and certified Brooklyn Basin Project EIR (2009), including approximately 3,100 residential dwelling units, 200,000 square-feet of ground-floor retail/commercial space; 29.9 acres of parks and public open space; and 170 marina slips.
- **Project Modifications:** Proposed Brooklyn Basin Marina Expansion Project, including 600 additional residential units, 166 additional recreational marina slips or berths in the Clinton Basin Marina, and a dock for an existing on-demand water taxi service that operates in the bay area.¹
- **Modified Project:** The Approved Project plus the Project Modifications.

This memorandum provides detail on project description, trip generation, access and circulation, parking supply and demand, transit demand, intersection operations analysis, collision assessment, congestion management program analysis, and recommended updates to the *Brooklyn Basin Transportation Demand Management Plan* (Nelson Nygaard, 2014).

¹ While the transportation analysis assumes 166 additional berths, the Project Modifications would include 158 new berths in addition to the Approved Project. In addition, for the purposes of a conservative analysis, the landing dock infrastructure is treated as the physical equivalent of two marina berths. The combined total of 160 berths is still less than the conservative assumption of 166 berths used in this analysis.



Project Description

The project site is in Oakland on Embarcadero generally between 5th Avenue and 9th Avenue. An Environmental Impact Report (EIR) for the Approved Project was certified and approved in 2009 and included 3,100 residential units, 200,000 square-foot of ground-floor retail/commercial and civic spaces, 29.9 acres of parks and public open space, and 170 marina slips. The Project Modifications include the following:

- 600 additional multi-family housing units
- 166 additional recreational marina slips²
- A dock for an existing on-demand water taxi service that operates in the bay area with limited service provided during commute periods (landing dock infrastructure is treated as the physical equivalent of two marina slips or berths for trip generation purposes)

The Project Modifications would be accommodated within the building envelopes of the Approved Project as presented in the 2009 EIR. No changes are proposed to the circulation elements within the Approved Project site plan and therefore, no additional site plan analysis is needed at this time. Any changes to the site plan or additional changes to the Approved Project would require approval from the City prior to development. **Figure 1** shows Brooklyn Basin's location and the proposed study area for the Project Modifications.

Trip Generation

Trip generation is the process of estimating the number of autos that would likely access a proposed project. Trip generation data published by the Institute of Transportation Engineers (ITE) in *Trip Generation Manual* (Tenth Edition, 2017) was used as a starting point to estimate auto trip generation.

Table 1 summarizes trip generation for the Project Modifications, which are estimated to generate 2,830 daily trips, including 175 AM peak and 230 PM peak hour trips.

ITE data is based on data collected at mostly single-use, suburban sites where driving is often the only travel mode. The Project Modifications would be a part of a dense, mixed-use urban environment where many trips would be walk, bike, or transit trips. Since the project site is just under one mile from Lake Merritt BART station and is in an urban environment, the City of Oakland's *Transportation Impact Review Guidelines* (TIRG) recommends a 23.1-percent reduction from the ITE-

² See footnote 1.



based trip generation to account for non-auto trips. This reduction is based on commute data for Alameda County from the 2014 five-year estimates of the U.S. Census Bureau American Community Survey (ACS), which shows that the non-automobile mode share for urban areas³ over one mile away from a BART station⁴ is about 23.1-percent.

Table 1: Project Modification Trip Generation

Land Use	Units ¹	ITE Code	Daily	AM Peak Hour			PM Peak Hour		
				In	Out	Total	In	Out	Total
Multi-Family Housing (Mid-Rise) ²	600 DU	221 ²	3,270	56	160	216	161	103	264
Marina ³	166 Berths ³	420 ⁴	410	4	8	12	21	14	35
ITE Auto Trip Generation			3,680	60	168	228	182	117	299
<i>City of Oakland Trip Generation Adjustment⁵</i>			-850	-14	-39	-53	-42	-27	-69
Total Project Modification Auto Trip Generation			2,830	46	129	175	140	90	230

Notes:

1. DU = Dwelling Units; Berths = number of proposed recreational boat slips
2. ITE Trip Generation (10th Edition, 2017) land use category 221 (Multi-Family Housing, Mid-Rise):
 Daily: T=5.44*X
 AM Peak Hour: T=0.36*X (26% in; 74% out)
 PM Peak Hour: T=0.44*X (61% in; 39% out)
3. While the transportation analysis assumes 166 additional berths, the Project Modifications would include 158 new berths in addition to the Approved Project. In addition, for the purposes of a conservative analysis, the landing dock infrastructure is treated as the physical equivalent of two marina berths. The combined total of 160 berths is still less than the conservative assumption of 166 berths used in this analysis.
4. ITE Trip Generation (10th Edition, 2017) land use category 420 (Marina)
 Daily: T=2.41*X
 AM Peak Hour: T=0.07*X (33% in; 67% out)
 PM Peak Hour: T=0.21*X (60% in; 40% out)
5. The 23.1% trip reduction is based on the City of Oakland's *Transportation Impact Review Guidelines* for development in an urban environment over one mile from a BART station.

Source: Fehr & Peers, 2021.

Trip generation for the Project Modifications residential land use was estimated using ITE land use category "Multifamily Housing (Mid-Rise)" (land use code 221). trip generation for the recreational

³ The City of Oakland's TIRG defines an urban environment as an area with a density of 10,000 persons-per-square-mile or greater. Based on the project description, the Brooklyn Basin project (approved plus proposed project) would have a density greater than 10,000 persons-per-square-mile.

⁴ The proposed project is approximately 0.9 miles away from the Lake Merritt BART station. This analysis conservatively applies rates assuming it is greater than one mile away from a BART station.



marina berths was estimated using the ITE land use category “Marina” (land use code 420). Both are consistent with land use categories used in the approved 2009 EIR for the Approved Project.

At the dock opening the existing on-demand water taxi service in the bay area is expected to operate only one to two trips during commute hours one to two days a week. Due to the proximity to the Jack London Square Ferry Terminal, and no dedicated parking for water taxi riders, it is assumed the water taxi would be used by project residents and employees only and therefore generate no auto trips. Non-project residents and employees are expected to use the Jack London Square Ferry Terminal that has frequent, scheduled service, public parking, and is located just a mile west of the Project site. Even though the landing dock infrastructure is expected to generate no auto trips, for purposes of a conservative trip generation, the landing dock infrastructure is treated as the physical equivalent of two marina berths.

Active and Transit Modes Trip Generation

Consistent with the City of Oakland’s TIRG, **Table 2** presents the trip generation estimates for all travel modes for the Project Modifications.

Table 2: Project Modification Trip Generation by Travel Mode¹

Mode	Mode Share Adjustment Factors ²	Daily	AM Peak Hour	PM Peak Hour
Automobile	76.9%	2,830	175	230
Transit	17.9%	660	41	53
Bike	1.9%	70	4	6
Walk	2.0%	80	4	6
Total Trips		3,640	224	295

1. Based on active and transit mode share factors outlined in the City of Oakland’s TIRG, assuming the project site is in an urban environment (density over 10,000 people per square mile) more than 1.0 mile from a BART station.
2. Percentages do not add to 100%. Per TIRG the difference is considered “Other”.

Source: Fehr & Peers, 2021.

Trip Distribution and Assignment

The trip distribution process is used to estimate how the auto trips generated by the Project Modifications would be distributed across the roadway network. The trip distribution for the 2009 EIR had been developed based on known travel patterns, locations of complementary land uses, and results from the Alameda County Transportation Commission’s Travel Demand Model. The residential units included in the Project Modification would be accommodated within the building



envelopes of the Approved Project and no significant changes in local and regional travel patterns have occurred, therefore the trip distribution for the Project Modifications and Approved Project are expected to be comparable. For this reason, the trip distribution developed for the 2009 EIR was applied to the Project Modifications. **Figure 2** shows the trip distribution for the Approved Project and Project Modifications. Trips generated by the Project Modifications were assigned to the roadway network according to the trip distribution shown on Figure 2. **Figure 3** shows the resulting trip assignment by roadway segment.

Study Intersection Selection

All intersections that were identified in the EIR to be impacted by the Approved Project were selected to be re-evaluated with the Project Modifications trips to determine if the Project Modifications further impact the intersections (using the 2009 EIR significance criteria) and to confirm that the mitigation measures previously identified are still applicable. Additional study intersections were also identified based on the following criteria outlined in the TIRG:

- All intersections of streets adjacent to the project site
- All signalized intersections, all-way stop-controlled intersections or roundabouts where 100 or more peak hour trips are added by the project
- All signalized intersections with 50 or more project-related peak hour trips and existing LOS D-E-F
- Side-street stop-controlled intersections where 50 or more peak hour trips are added by the project to any individual movement other than the major-street through movement

Applying these criteria, the following list of study intersections is recommended for further analysis, as they are adjacent to the Project and/or locations identified in the EIR for having significant impacts due to Approved Project-related trips:

1. Embarcadero/Oak Street
2. 5th Street/Broadway
3. 6th Street/Jackson Street/ I-880 Northbound On-Ramp
4. Embarcadero/5th Avenue
5. Embarcadero/I-880 Northbound Off-Ramp-6th Avenue (Project Access Point)
6. Atlantic Avenue/Webster Street
7. Embarcadero/Broadway
8. 5th Street/Oak Street/ I-880 Southbound On-Ramp
9. West Grand Avenue/Harrison Street
10. Lakeshore Avenue/Foothill Boulevard



11. Lakeshore Avenue/MacArthur Boulevard
12. Lakeshore Avenue/Lake Park Avenue
13. Embarcadero/I-880 Southbound On-Ramp-10th Avenue
14. 5th Avenue/7th-8th Streets
15. 14th Avenue/7th-12th Streets (Southbound)
16. Foothill Boulevard/14th Avenue (Westbound)
17. Foothill Boulevard/14th Avenue (Eastbound)
18. 16th Street/23rd Avenue
19. Embarcadero/7th Avenue (Project Access Point – with project conditions only)
20. Embarcadero/8th Avenue (Project Access Point – with project conditions only)
21. Embarcadero/9th Avenue (Project Access Point – with project conditions only)
22. Embarcadero/4th Avenue (Project Access Point – with project conditions only)

Intersection Analysis

The LOS assessment for the Project Modifications utilized the 2009 EIR methodology and significance criteria, except for slight modifications to the analytical tools employed:

- The EIR utilized the 2000 Highway Capacity Manual (HCM) for the analysis of traffic operation at intersections. This assessment utilized the 2010 HCM methodologies, in line with current best practices.
- The EIR utilized the 2000 HCM and Traffix software for analysis of All-Way Stop Control and Two-Way Stop Control intersections. This assessment utilized the 2010 HCM methodologies and Synchro software, in line with current best practices.

LOS was evaluated during typical morning (7:00 to 9:00 AM) and evening (4:00 to 6:00 PM) peak periods for each of the study intersections identified for the following scenarios:

- Existing: Existing (2018) conditions based on December 2018 traffic counts
- Existing with Approved Project: Existing (2018) conditions plus Approved Project-related traffic. Approved Project analysis utilizes the trip generation, distribution, and assignment approved as part of the EIR. All intersection-related mitigation measures (Mitigation Measure B.1, B.2, and B.3) identified in the EIR are assumed to have been implemented in this scenario.
- Modified Project: Existing (2018) conditions plus Approved Project traffic plus Project Modifications traffic. Approved Project analysis utilizes the trip generation, distribution, and assignment approved as part of the EIR. All intersection-related mitigation measures (Mitigation Measure B.1, B.2, and B.3) identified in the EIR are assumed to have been implemented in this scenario.



Existing (2018) traffic counts for the identified study intersections were collected on a typical school day in early December 2018. The Embarcadero Bridge has been closed due to construction since 2014, affecting travel patterns along Embarcadero and 7th and 8th Streets. Minor traffic re-assignment was done to account for the Embarcadero Bridge closure. This traffic re-assignment is captured in all evaluated scenarios. Traffic count sheets are provided in **Attachment A**. Existing traffic signal timing data was collected from the City of Oakland Department of Transportation.

Project Modifications Impacts

The LOS results are provided in **Table 3**. LOS Worksheets are provided in **Attachment B**. Peak hour volumes and lane configurations for each study intersection and each scenario are included in **Attachment C**. The LOS assessment concluded that the addition of traffic generated by the Project Modifications would not cause any additional impacts beyond those identified in the EIR.

Access and Circulation Review

The City's TIRG requires a detailed site plan analysis to confirm a project is providing access and circulation in line with City standards and best practices. The Project Modifications would be accommodated within the building envelopes approved as part of the 2009 EIR process and includes no changes to the Approved Project's site plan's transportation network. For this reason, additional access and circulation review is not needed at this time. Any subsequent changes or additions to the site plan would require final plan review by the City to ensure they are compliant.

Collision Analysis

The City's TIRG requires a collision history analysis for study intersections and roadway segments in proximity to a project site. The TIRG defines study intersections as:

- All intersections of streets adjacent to the project site,
- All signalized intersections, all-way stop-controlled intersections or roundabouts where 100 or more peak hour trips are added by the project,
- All signalized intersections with 50 or more project-related peak hour trips and existing LOS D-E-F, and
- Side-street stop-controlled intersections where 50 or more peak hour trips are added by the project to any individual movement other than the major-street through movement.



Table 3: Intersection Level Of Service and Delay (Seconds/Vehicle)¹

No.	Intersection	Traffic Control ²	AM Peak Hour						PM Peak Hour					
			Existing		Existing with Approved Project		Existing with Modifications and Approved Project ³		Existing		Existing with Approved Project		Existing with Modifications and Approved Project ³	
			LOS	Delay	LOS	Delay	LOS	Delay	LOS	Delay	LOS	Delay	LOS	Delay
1	Embarcadero/Oak Street	SSSC/Signal ³	C	16.8	A	7.1	A	7.5	E	48.8	C	30.2	D	38.8
2	5th Street/Broadway	Signal	C	30.4	C	30.1	C	30.0	D	45.5	D	43.1	D	43.0
3	6th Street/Jackson Street/ I-880 Northbound On-Ramp	Signal	B	10.4	B	16.0	B	16.6	A	9.8	B	15.7	B	16.1
4	Embarcadero/ 5th Avenue	SSSC/Signal ³	F	>80	B	13.8	B	14.7	B	10.1	D	48.3	D	53.7
5	Embarcadero/I-880 Northbound Off-Ramp-6th Avenue	SSSC/Signal ³	C	16.6	A	6.7	A	6.8	D	31.1	D	38.6	D	44.2
6	Atlantic Avenue/Webster Street	Signal	C	28.5	C	27.8	C	27.8	C	28.4	C	27.6	C	27.7
7	Embarcadero/Broadway	AWSC	A	7.9	B	12.5	B	12.6	A	9.2	B	12.0	B	12.1
8	5th Street/Oak Street/ I-880 Southbound On-Ramp	Signal	C	21.1	C	21.3	C	21.4	B	18.4	D	38.1	D	39.3
9	West Grand Avenue/Harrison Street	Signal	C	24.1	C	24.2	C	24.2	D	35.3	D	35.0	D	35.0
10	Lakeshore Avenue/ Foothill Boulevard	Signal	B	11.8	B	12.4	B	12.4	A	6.7	A	7.3	A	7.3
11	Lakeshore Avenue/ MacArthur Boulevard	Signal	C	27.0	C	28.4	C	28.4	C	31.6	C	32.0	C	32.1
12	Lakeshore Avenue/ Lake Park Avenue	Signal	E	55.8	D	36.4	D	36.4	D	35.9	C	33.4	C	33.5
13	Embarcadero/I-880 Southbound Off-Ramp-10th Avenue	AWSC/Signal ³	A	5.0	C	20.6	C	21.3	A	5.0	C	22.8	C	25.4



No.	Intersection	Traffic Control ²	AM Peak Hour						PM Peak Hour					
			Existing		Existing with Approved Project		Existing with Modifications and Approved Project ³		Existing		Existing with Approved Project		Existing with Modifications and Approved Project ³	
			LOS	Delay	LOS	Delay	LOS	Delay	LOS	Delay	LOS	Delay	LOS	Delay
14	5th Avenue/7th-8th Streets	Signal	B	13.9	B	13.8	B	13.8	B	14.8	B	17.6	B	18.6
15	14th Avenue/7th-12th Streets	Signal	B	12.6	B	12.7	B	12.7	B	19.6	B	12.5	B	12.4
16	Foothill Boulevard/14th Avenue (Westbound)	Signal	C	28.1	D	35.9	D	35.9	B	15.8	B	14.5	B	14.5
17	Foothill Boulevard/14th Avenue (Eastbound)	Signal	B	19.0	C	33.1	C	32.9	B	13.7	B	13.3	B	13.3
18	16th Street/23rd Avenue	Signal	A	5.5	A	5.6	A	5.6	B	10.0	A	9.3	A	9.3
19	Embarcadero/7th Avenue	Signal	-	-	A	2.9	A	2.9	-	-	A	9.0	A	9.0
20	Embarcadero/8th Avenue	Signal	-	-	A	3.2	A	3.2	-	-	A	6.5	A	6.4
21	Embarcadero/9th Avenue	SSSC	-	-	C	23.1	C	24.0	-	-	C	22.6	C	23.0
22	Embarcadero/4th Avenue	Signal	-	-	A	10.0	B	10.2	-	-	A	8.7	B	10.5

Notes:

The LOS/Delay for the Side-Street-Stop-Control (SSSC) intersections represent the worst movement or approach; for Signalized and All-Way-Stop-Control (AWSC) the LOS/Delay represent overall intersection. Significant impacts are denoted in Bold typeface.

1. HCM 2010 methodology was utilized for this analysis. HCM 2000 was used at select locations where HCM 2010 does not apply.
2. SSSC = Side-Street Stop Control; AWSC = All-Way Stop Control
3. Project frontage intersections become signalized in Existing with Approved Project and Existing with Modifications and Approved Project conditions. It is assumed that signalization of the Embarcadero/Oak Street intersection will include separation of the eastbound left and right turn lanes approaching the intersection.

SOURCE: Fehr & Peers, 2021.



Based on these criteria and project trip generation and distribution, the following list of study intersections were considered in the collision analysis:

1. Embarcadero/5th Avenue
2. Embarcadero/I-880 Northbound Off-Ramp/6th Avenue
3. Embarcadero/I-880 Southbound On-Ramp/10th Avenue

In addition to these intersections, roadway segments along the project frontage were evaluated:

4. Embarcadero – 4th Avenue to 5th Avenue
5. Embarcadero – 5th Avenue to 6th Avenue
6. Embarcadero – 8th Avenue to 9th Avenue
7. Embarcadero – 9th Avenue to 10th Avenue

A five-year history (January 1, 2012 to December 31, 2016)⁵ of collision data in the study area was obtained from the Statewide Integrated Traffic Records System (SWITRS) and evaluated for the identified study intersections and segments. This data reflects conditions prior to the Embarcadero Bridge construction. **Table 4** summarizes the collision data by type and location, and **Table 5** summarizes the collision data by severity and location.

As shown in Table 4, 12 collisions were reported during this five-year timeframe along the study roadway segments and intersections. The top three collision types were rear-end collisions (four collisions; 33 percent); head-on collisions (two collisions; 17 percent), and bicycle-involved collisions (two collisions; 17 percent). Most collisions were due to unsafe speeds (four collisions: 33 percent). Pedestrians were not involved in any of the reported collisions.

The *Highway Safety Manual* (HSM, Predictive Method - Volume 2, Part C) provides a methodology to predict the number of collisions for intersections and street segments based on roadway and intersection characteristics, such as vehicle and pedestrian volumes, number of lanes, signal phasing, on-street parking, and number of driveways. **Table 6** presents predicted collision frequencies for the seven study intersections and segments using the HSM Predictive Method for Urban and Suburban Arterials and compares predicted collision frequencies to the reported collision frequencies.

⁵ While 2017 data is available, the Embarcadero Bridge construction had started. For this reason, it was excluded from this assessment.



Table 4: Summary of Collisions by Type

Location	Head-on	Side-swipe	Rear-End	Broad-side	Hit Object	Pedestrian-Involved	Bicycle-Involved	Over-turned	Not Stated	Other	Total
Intersection											
1. Embarcadero/5 th Avenue	1	1	2	0	0	0	1	0	0	0	5
2. Embarcadero/I-880 Northbound Off-Ramp/6 th Avenue	1	0	1	1	0	0	0	0	0	0	3
3. Embarcadero/I-880 Southbound On-Ramp/10 th Avenue	0	0	1	0	1	0	0	0	0	0	2
Segments											
4. Embarcadero - 4 th Avenue to 5 th Avenue	0	0	0	0	0	0	0	0	0	0	0
5. Embarcadero – 5 th Avenue to 6 th Avenue	0	0	0	0	0	0	1	0	0	0	1
6. Embarcadero - 6 th Avenue to 8 th Avenue	0	0	0	0	0	0	0	0	0	0	0
7. Embarcadero - 8 th Avenue to 9 th Avenue	0	0	0	0	0	0	0	0	0	0	0
8. Embarcadero – 9 th Avenue to 10 th Avenue	0	0	0	0	0	0	0	1	0	0	1
Total	2	1	4	1	1	0	2	1	0	0	12

Notes:

1. Based on SWITRS five-year collision data reported from January 1, 2012 to December 31, 2016.

Source: Fehr & Peers, 2021.



Table 5: Summary of Collision Severity¹

Location	Property Damage Only Collisions	Injury Collisions	Fatality Collisions	Total	Person Injuries ²			
					Bike	Ped	Driver/Passenger	Total
Intersection								
1. Embarcadero/5 th Avenue	4	1	0	5	1	0	0	1
2. Embarcadero/I-880 Northbound Off-Ramp/6 th Avenue	0	3	0	3	0	0	5	5
3. Embarcadero/I-880 Southbound On-Ramp/10 th Avenue	1	1	0	2	0	0	1	1
Segments								
4. Embarcadero - 4 th Avenue to 5 th Avenue	0	0	0	0	0	0	0	0
5. Embarcadero – 5 th Avenue to 6 th Avenue	0	1	0	1	1	0	0	1
6. Embarcadero - 6 th Avenue to 8 th Avenue	0	0	0	0	0	0	0	0
7. Embarcadero - 8 th Avenue to 9 th Avenue	0	0	0	0	0	0	0	0
8. Embarcadero – 9 th Avenue to 10 th Avenue	0	1	0	1	0	0	1	1
Total	5	7	0	12	2	0	7	9

Notes:

1. Based on SWITRS five-year collision data reported from January 1, 2012 to December 31, 2016.
2. The total number of person injuries may not sum to the number of injury collisions; more than one person may be injured in an injury collision.

Source: Fehr & Peers, 2021.



Table 6: Predicted and Actual Collision Frequencies

Location	Actual Collision Frequency ¹ (per year)	Predicted Collision Frequency ² (per year)	Difference	Higher Than Predicted?
Intersection				
1. Embarcadero/5th Avenue	1.0	5.7	4.7	no
2. Embarcadero/I-880 Northbound Off-Ramp/6 th Avenue	0.6	3.7	3.1	no
3. Embarcadero/I-880 Southbound On-Ramp/10 th Avenue	0.4	2.8	2.4	no
Segments				
4. Embarcadero - 4 th Avenue to 5 th Avenue	0.0	0.7	0.7	no
5. Embarcadero – 5 th Avenue to 6 th Avenue	0.2	0.6	0.4	no
6. Embarcadero - 6 th Avenue to 8 th Avenue	0.0	0.8	0.8	no
7. Embarcadero - 8 th Avenue to 9 th Avenue	0.0	0.2	0.2	no
8. Embarcadero – 9 th Avenue to 10 th Avenue	0.2	0.2	0.0	no

Notes:

1. Based on five-year collision data reported from January 1, 2012 to December 31, 2016.
2. Based on the Highway Safety Manual Predictive Method (Volume 2, Part C).

Source: Fehr & Peers, 2021.

Attachment D provides detailed predicted collision frequency calculation sheets based on the HSM methodology. Intersections or roadway segments with collision frequencies greater than the predicted frequency should have their collision trends and potential roadway or intersection characteristics evaluated in greater detail.

As shown in Table 6, all study locations have a lower reported collision frequency than predicted by the HSM and so no further collision analysis is needed.

Congestion Management Program Analysis

The Alameda County Congestion Management Program (CMP) requires the Near-Term (2020) and Cumulative Year (2040) assessment of development-driven impacts to regional roadways. Because the Project Modifications would generate more than 100 net-new evening peak hour trips, Alameda County Transportation Commission (Alameda CTC) requires the use of the Countywide Travel Demand Model to assess the impacts on regional roadways in the project site vicinity. The CMP



roadways near the Project Modification include East 8th Street, Harrison Street, Webster Street, and Interstate-880 (I-880).

The Alameda CTC Countywide Travel Demand Model (Model) used for this analysis is a regional travel demand model that uses socioeconomic data and roadway and transit network assumptions to forecast traffic volumes and transit ridership using a four-step modeling process: 1) trip generation, 2) trip distribution, 3) mode split, and 4) trip assignment. This process considers changes in travel patterns due to future growth and balances trip productions and attractions. This version of the Model is based on Association of Bay Area Governments (ABAG) Projections 2013 land uses for year 2020 and 2040. The Year 2040 Model employed is the off-the-shelf Model with land use modifications to include planned development under the Downtown Oakland Specific Plan and Oakland Waterfront Ballpark District Project.

To present a more conservative CMP analysis, it is assumed that the Project Modifications are not already included in the Model. The “constrained” traffic forecasts for the 2020 and 2040 scenarios were extracted from the Model for the CMP roadway segments and used as the “without Project” forecasts. Vehicle trips generated by the Project Modifications were added to the “without Project” forecasts to estimate the “with Project” forecasts.

The CMP segments were assessed using a volume-to-capacity (v/c) ratio methodology (Transportation Research Board, 1985). For freeway segments, a per-lane capacity of 2,000 vehicles-per-hour (vph) was used, consistent with the latest CMP documents. For arterials, a per-lane capacity of 800 vph was used. Roadway segments with a v/c ratio greater than 1.00 signify LOS F. The “with Project” results were compared to the baseline results for years 2020 and 2040. **Attachment E** provides the 2020 and 2040 peak-hour volumes, v/c ratios, and the corresponding LOS for without and with Project conditions.

The Project Modifications would contribute to 2020 and 2040 increases in traffic congestion on CMP roadways. However, the Project Modifications would not cause a CMP roadway segment to degrade from LOS E or better to LOS F, or increase the v/c ratio by more than 0.03 for roadway segments that would operate at LOS F without the Project Modifications.

Transportation Demand Management Plan Update

The City’s TIRG requires project developers to prepare a Transportation Demand Management (TDM) Plan to record their commitment to implement physical site improvements and operational strategies to reduce the amount of single-occupancy auto travel to, from, and within the project



site. The *Brooklyn Basin Transportation Demand Management Plan* (Nelson Nygaard, 2014) was prepared for the Approved Project, as required by the project's Conditions of Approval (COA, #22). Since the plan was prepared, the City has issued specific guidance on required and suggested TDM strategies as part of the TIRG and the City's Standard Conditions of Approval. **Attachment F** presents suggested updates to the *Brooklyn Basin Transportation Demand Management Plan* to ensure it is compliant with the most up-to-date City guidelines, inclusive of new mobility options, and reflects industry best practices.

Recommendation 1: Update the *Brooklyn Basin Transportation Demand Management Plan* (Nelson Nygaard, 2014) to be inclusive of the recommendations outlined in Attachment F to ensure consistency with the *Transportation Impact Review Guidelines* and industry best practices. At a minimum, incorporate annual compliance reporting into the *Brooklyn Basin Transportation Demand Management Plan*.

The updated TDM Plan as described in Attachment F was evaluated to determine the potential Vehicle Trip Reduction resulting from the TDM Plan implementation. **Table 7** summarizes the quantifiable TDM measures based on available research compiled in *Quantifying Greenhouse Gas Mitigation Measures* (California Air Pollution Control Officers Association), that could be implemented for the Modified Project to achieve at least a 20% reduction in vehicle trips. As noted in the table, implementing measures in the TDM Plan yields a vehicle trip reduction range between 9 and 35 percent depending on the effectiveness of the measures. Due to the location of the project in an area that has good transit, bicycle, and pedestrian access, it is expected that the moderate to higher end of the vehicle trip reduction will be achieved with the TDM Plan. Annual monitoring will be necessary to ensure the TDM Plan successfully reduces vehicle trips.



Table 7: Estimated Vehicle Trip Reduction for Updated TDM Measures

TDM Program Element	Estimated Vehicle Trip Reduction ¹
Brooklyn Basin Taxi	0.1-8.2%
Pedestrian network	up to 2%
Shared commercial parking	2.8-5.5%
Unbundled residential parking	2.6-13%
Metered on-street parking	2.8-5.5%
Carsharing	0.4-0.7%
Total Estimated Vehicle Trip Reduction	8.7-34.9%

Notes:

1. Vehicle Trip Reduction rates based on California Air Pollution Control Officers Association (CAPCOA) Greenhouse Gas Mitigation Measures. The focus of the CAPCOA document is reductions to VMT but the research used to generate the reductions also indicates vehicle trip reductions are applicable as well. For the purposes of this analysis the VTR is assumed to equal the VMT reduction. See the cited CAPCOA research for more information and related information on page 8 of the BAAQMD Transportation Demand Management Tool User's Guide (June 2012).

Source: Fehr & Peers, 2021.

Parking Assessment

This section summarizes anticipated parking demand and compares it to the proposed parking allotment identified with the Project Modifications to determine whether a parking shortage or surplus would exist.

Proposed Parking Supply

The Modified Project will include a total of 3,700 residential units, 200,000 square-feet of ground-floor retail/commercial and civic spaces, 29.9 acres of parks and public open space, 336 marina slips, and a dock for an existing on-demand water taxi service in the bay area. **Table 8** summarizes approved parking for Phase I and Phase II and proposed parking for Phase III and Phase IV of the Modified Project. Total residential parking for the Modified Project would provide 0.85 parking spaces per dwelling unit with 1.0 spaces per unit provided with Phase I and Phase II development and 0.75 spaces per unit provided for Phase III and Phase IV development. The parking supply and demand associated with the Approved Project was evaluated in the SEIR. The Project Modifications only include changes to the residential parking supply with Phase III and Phase IV development.



Table 8: Proposed Parking for Modified Project

Location	Residential (units)	Retail (sf)	Residential Parking	Other Parking
Phase I and II				
Shoreline Park	-	21,800	-	38
Parcel A	254	-	306	
Parcel B	241	3,000	241	0
Parcel C	241	3,500	240	0
Parcel D	243	4,000	170	14
Parcel E	174	-	174	-
Parcel F	211	-	192	
Parcel G	371	34,556	329	82
Parcel H	380	16,598	274	33
Parcel J	378	2,700	329	
Phase III and IV				
Approved for Phase III and IV	607	113,846	455 ¹	262
Project Modifications, (Phase III and IV Add-Ons) ²	600	-	450 ¹	34
Total Modified Project				
Total	3,700	200,000	3,160	463

Notes:

1. Residential parking for phases III and IV of the Modified Project is proposed to be provided at a rate 0.75 parking spaces per dwelling unit. Retail and boat slip parking remain consistent with the waterfront zoning including 1 space per 500 s.f. for retail and 1 space per 5 boat slips.
2. This analysis assumes Project Modifications include 600 additional residential units, 166 additional recreational marina slips in the Clinton Basin Marina, and a dock for an existing on-demand water taxi service in the bay area to be included in Phases III and IV.

Source: City of Oakland, 2019/2020.

Phase III and Phase IV Residential Parking Demand

To estimate residential parking demand amongst potential Brooklyn Basin residents in Phases III and IV, vehicle ownership information was collected from the 2013-2017 U.S. Census American Community Survey (ACS). The ACS data estimates renters and homeowners in the census tract⁶ in which the Brooklyn Basin is located have an average of 1.1 vehicles per household. If residents living in Phases III and IV owned cars at rates like existing Census tract residents, a total of 1,328

⁶ Based on renter- and owner-occupied survey findings from the 2013-2017 American Community Survey (ACS); data summarized in "Table B20544: Tenure by Vehicles Available" for census tract 4060.



residential parking spaces would be needed. Project Modifications propose to include residential parking in Phases III and IV at a rate of 0.75 spaces per unit, for a total of 905 residential spaces.

If no TDM strategies were implemented, residential parking supply for the Project Modifications would be inadequate. The likely outcome of providing less residential parking supply than anticipated demand is that people with less need for an automobile would self-select to live in the residential units. However, as the Project Modifications are required to include an extensive TDM Plan (discussed above), project residents are likely to have lower rates of car ownership. Unbundled parking, a TDM strategy required by the City's TIRG and included in the recommended updates to the *Brooklyn Basin Transportation Demand Management Plan* (Nelson Nygaard, 2014), has been estimated to reduce car ownership rates up to 38%, dependent on monthly parking fees assessed⁷. Taking these factors into account, it is likely that parking demand can be effectively managed through an effective TDM Plan, unbundled parking fees and residents self-selecting to live at the Project site because they do not own a car and so do not require a parking space.

Transit Operations

This section summarizes the anticipated transit demand generated by the project and determines whether the additional demand could be accommodated with existing and planned BART and AC Transit bus services. Access to BART and Alameda-Contra Costa Transit District (AC Transit) services from the project site is evaluated. The viability of existing water taxi service also serving the dock at the project site to San Francisco is also assessed.

Existing and Planned Transit Services

Transit services in the project vicinity include AC Transit bus service, Bay Area Rapid Transit (BART), Amtrak, and ferry service. Most nearby transit services are concentrated along Broadway corridor in Downtown Oakland and in Jack London Square. Each of these services is described below.

Alameda-Contra Costa Transit District (AC Transit)

AC Transit is the primary bus service provider in 13 cities and adjacent unincorporated areas in Alameda and Contra Costa Counties, with Transbay service to destinations in San Francisco, San Mateo and Santa Clara Counties. The primary bus lines nearest the Project site are line 96 and line 62, as described below:

⁷ Based on research by the Victoria Transport Policy Institute, as documented in *Parking Requirement Impacts on Housing Affordability* (2009); assuming that free parking is not available nearby.



- Line 96 provides Fruitvale Montana/Alameda Point connections from 6 a.m. to 11 p.m. on weekdays and weekends with 30-minute headways. The route runs on 14th Avenue via 12th Street, 5th Avenue, and 7th/8th Streets. The closest bus stops to the Project site are located at the 5th Avenue/E 10th Street intersection, approximately 0.4 miles or an 8-minute walk from the Project site.
- Line 62 runs between the West Oakland and Fruitvale BART stations. It runs from 6 a.m. to 12:30 a.m. on weekdays and weekends with 30-minute headways. The closest bus stop to the Project site is located at the 5th Avenue/E 10th Street intersection, approximately 0.4 miles or an 8-minute walk from the Project site.

While no routes directly serve the Project site, several AC Transit lines can be accessed at the Lake Merritt BART station (about 0.9 miles or an 18-minute walk from the Project site) including Line 18, 62, 88, and 96. AC Transit's Line 12 serves the Jack London Square Amtrak Station (about 0.8 miles or a 16-minute walk from the Project site). The Free Broadway Shuttle stops at the Webster Street / Embarcadero intersection about 1.0 miles or a 20-minute walk from the Project site. Figure IV.B-1.2 in the CEQA chapter shows the transit service.

The Approved Project has required conditions and compliance that would be applied to the Project Modifications, including a written commitment from AC Transit to provide bus service or a private shuttle operations plan that would serve the Project site. The bus service plan or private shuttle operations plan will include a commitment of financial participation for peak hour service, routing, schedule, and phased implementation according to the threshold established for the issuance of occupancy permits for the transportation improvements phasing plan. The service will become operative within six months of the occupancy of the 1,000th unit of the Approved Project.

Bay Area Rapid Transit (BART)

BART provides regional rail service between San Francisco, northern San Mateo County, and the East Bay. The average weekday ridership in 2019 was about 411,000 passengers systemwide (BART, 2019). The closest BART station is Lake Merritt, about 0.9 miles away or an 18-minute walk with daily ridership of about 14,200 entries and exits combined. The Lake Merritt Station is in Oakland's Chinatown, with an entrance at the Oak Street/8th Street intersection. The station is located underground, has four access points, including access via stairs, an escalator, and elevator. The station is served by the Dublin/Pleasanton-Daly City, Richmond-Warm Springs/South Fremont, and Warm Springs/South Fremont-Daly City lines. Service is scheduled at 15-minute frequencies on each line during the peak periods and 20-25-minute frequencies during the off-peak hours. On Sundays, the station is served by Dublin/Pleasanton-Montgomery St/Daly City and Richmond-Warm Springs/South Fremont lines with 20-minute frequencies.



BART allocated funds for a new fleet of train cars which will reduce the time it takes people to exit and enter train cars by up to 50 percent, a new maintenance facility, and a new train control system which is expected to increase system capacity through the Transbay Tube from 24 to 30 trains per hour per direction and be implemented by 2028. BART is also analyzing the feasibility of a second Transbay Tube. A second Transbay Tube could expand systemwide capacity to meet projected ridership demand. While funding is available for studies, no capital funds have been allocated.

Free Broadway Shuttle

AC Transit contracts with Oakland to operate the Free Broadway Shuttle along Broadway and some adjacent streets. The Shuttle operates daytime service Mondays-Fridays 7am-7pm between Embarcadero West (Jack London Square) and Grand Avenue. Daytime shuttles run every 11 minutes during commute hours and lunchtime, and every 12-15 minutes otherwise. Night service operates Mondays-Fridays from 7pm-10pm between Embarcadero West and 27th Street. Night shuttles run every 12 minutes. The nearest bus stop for this service is at the Embarcadero / Webster Street intersection about 1 mile from the Project site or about a 20-minute walk.

Amtrak

Amtrak operates regional and interregional rail service through the Oakland Jack London Square Station on 2nd Street between Harrison Street and Jackson Street. This station is about 0.8 miles west of the Project site or about a 16-minute walk. Several lines use this Jack London Square Station, including the Capitol Corridor, the San Joaquin, and the Coast Starlight:

- Capitol Corridor connects Sacramento and San Jose through Oakland. This service provides 15 trains per direction on weekdays and 11 trains per direction on weekends. The typical headways are one hour during peak periods.
- San Joaquin connects Oakland and Bakersfield through Stockton. The service runs five trains in each direction. The scheduled trip time between Oakland and Stockton is about one hour and forty-five minutes.
- Coast Starlight connects Vancouver and Los Angeles through Sacramento, Oakland, and San Jose. The service runs one train in each direction daily.

Ferry Service

Jack London Square Ferry Terminal provides connections to all San Francisco terminals. In February 2019, average weekday ridership for Oakland Terminal was approximately 3,300 passengers. Ferry riders transfer for free to AC transit buses and are eligible for free parking in the 101 Washington parking garage. The weekday service operates between 6 a.m. and 9:25 p.m. with one-hour



headways during the peak periods, and about two-hour headways during off-peak periods. The weekend service operates between 10 a.m. and 7:10 p.m. about every 90 minutes to two hours.

Water Emergency Transportation Authority plans to expand the Oakland Estuary Service to handle existing and expected increases in ridership. A new Ferry Terminal is being constructed at Seaplane Lagoon, which will allow for Alameda residents to have direct service to several San Francisco and Peninsula ferry terminals. This will free up additional capacity to serve the Jack London Terminal and the Main Street Terminal in Alameda.

Estimated Project Transit Demand

Anticipated transit demand generated by the Modified Project is estimated by applying active and transit mode share factors outlined in the City of Oakland's TIRG to the ITE trip generation estimates. **Table 9** summarizes the estimated trip generation and travel mode split for the Modified Project which includes the Approved Project plus the Project Modifications being evaluated in the SEIR.

As noted above, the Modified Project would generate approximately 522 transit trips in the AM Peak Hour and 862 transit trips in the PM Peak Hour. Data from the American Community Survey (2014-2018) was referenced to estimate the proportion of these transit trips that would be taken by BART, AC Transit, Amtrak, and Ferry. **Table 10** summarizes these estimates, assuming the transit mode split for transit trips generated by the Modified Project would be like the transit commute mode split for existing area residents.



Table 9: Modified Project Trip Generation by Mode

Land Use	Size ¹	ITE Code	Daily	AM Peak Hour			PM Peak Hour		
				In	Out	Total	In	Out	Total
Multi-Family Housing (Mid-Rise) ²	3,700 DU	221	20,130	346	986	1,332	993	635	1,628
Marina ³	336 Berths	420	810	8	16	24	43	28	71
Shopping Center ⁴	170 KSF	820	8,630	149	91	240	389	421	810
Supermarket ⁵	30 KSF	850	3,210	69	46	115	162	156	318
ITE Trip Generation			32,780	572	1,139	1,711	1,587	1,240	2,827
Trip Generation by Travel Mode without TDM Plan⁶									
Auto Trip Generation			25,208	440	876	1,316	1,220	954	2,174
Transit Trip Generation			5,868	102	204	306	284	222	506
Bike Trip Generation			623	11	22	33	30	24	54
Walk Trip Generation			656	11	23	34	32	25	57
Trip Generation by Travel Mode Plus TDM Plan⁷									
Auto Trip Generation			20,167	352	701	1,053	976	764	1,740
Transit Trip Generation			10,007	174	348	522	484	378	862
Bike Trip Generation			1,062	19	37	56	51	41	92
Walk Trip Generation			1,119	19	39	58	55	43	97

1. DU = Dwelling Units; Berths = number of proposed recreational boat slips; KSF = 1,000 square feet
2. ITE Trip Generation (10th Edition, 2017) land use category 221 (Multi-Family Housing, Mid-Rise):
 Daily: $T=5.44 \times X$
 AM Peak Hour: $T=0.36 \times X$ (26% in; 74% out)
 PM Peak Hour: $T=0.44 \times X$ (61% in; 39% out)
3. ITE Trip Generation (10th Edition, 2017) land use category 420 (Marina):
 Daily: $T=2.41 \times X$
 AM Peak Hour: $T=0.07 \times X$ (33% in; 67% out)
 PM Peak Hour: $T=0.21 \times X$ (60% in; 40% out)
4. ITE Trip Generation (10th Edition, 2017) land use category 820 (Shopping Center):
 Daily: $\ln(T)=0.68 \times \ln(X)+5.57$
 AM Peak Hour: $T=0.50 \times X+151.78$ (62% in; 38% out)
 PM Peak Hour: $\ln(T)=0.74 \times \ln(X)+2.89$ (48% in; 52% out)
5. ITE Trip Generation (10th Edition, 2017) land use category 850 (Supermarket)
 Daily: $T=106.8 \times X$
 AM Peak Hour: $T=3.82 \times X$ (60% in; 40% out)
 PM Peak Hour: $\ln(T)=0.75 \times \ln(X)+3.21$ (51% in; 49% out)
6. Based on active and transit mode share factors outlined in the City of Oakland's TIRG, assuming the project site is in an urban environment (density over 10,000 people per square mile) more than 1.0 mile from a BART station:
 Automobile = 76.9%
 Transit=17.9%
 Bike=1.9%
 Walk=2.0%
7. Auto trip generation reduced 20% fulfilling the TDM Plan vehicle trip reduction requirements.

Source: Fehr & Peers, 2021



Table 10: Modified Project Transit Trip Generation

Transit Mode	Existing Transit Mode Share ¹	Daily	AM Peak Hour			PM Peak Hour		
			In	Out	Total	In	Out	Total
Bus	13.4%	1,341	23	47	70	65	51	116
BART	79.5%	7,956	139	276	415	385	300	685
Amtrak	4.8%	480	8	17	25	23	18	41
Ferry	2.3%	230	4	8	12	11	9	20
<i>Total Transit Trips</i>		10,007	174	348	522	484	378	862

Source: American Community Survey, 2014-2018 Five-Year Estimates, Table B08301 (Census Tract 4060).
 Fehr & Peers, 2021

Impact on BART

The Modified Project is projected to generate about 7,956 daily, 415 AM peak hour, and 685 PM peak hour BART trips. **Inset 1** depicts estimated weekday hourly entries and exits at Lake Merritt BART Station for Existing Conditions and Existing Plus Modified Project Conditions. At the AM peak hour (8:00am to 9:00am), station entries would increase approximately 23% with the addition of Modified Project-related entries. At the PM peak hour (5:00pm to 6:00pm), station exits would increase approximately 31% with the addition of Modified Project-related exits. While the increase in ridership at the Lake Merritt BART Station will be substantial observations indicate that the four station portals, fare gates, and station platform can accommodate the added riders.

Impact on AC Transit

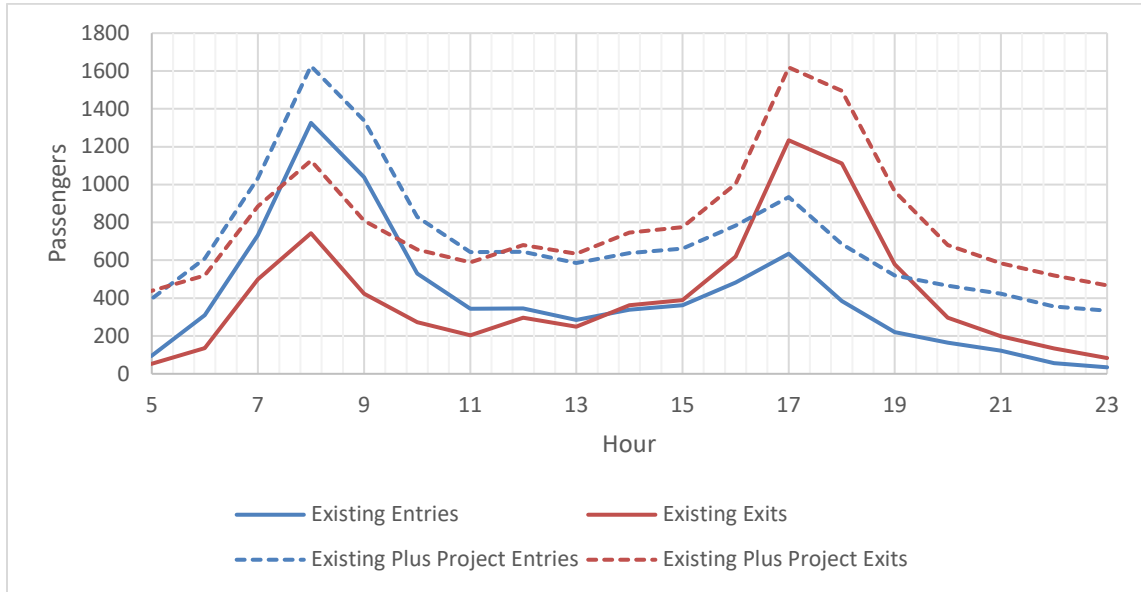
The Modified Project is expected to generate 1,341 daily bus trips, 70 trips (23 in, 47 out) during the AM peak hour, and 116 trips (65 in, 51 out) during the PM peak hour. The two closest AC Transit routes are Line 62 and Line 96 which are located within 0.4 miles from the Project site or an 8-minute walk. Bus riders would walk further to access Line 12, about 0.8 miles or a 16-minute walk (4-minute bike ride), or to access buses at Lake Merritt BART station, about 0.9 miles or an 18-minute walk (6-minute bike ride). Assuming Project-generated bus ridership would be limited to these five lines, the greatest impact to bus loading would occur during the PM peak hour when 65 people would ride one of the 12 buses⁸ toward the Project site that operate on these lines hourly. Given close proximity by bike to Amtrak and Lake Merritt BART stations and the large geographic diversity that the AC Transit bus lines serve it is assumed that bus riders would be distributed equally

⁸ Lines 12, 62, and 96 each operate two buses per hour in each direction of travel, while Lines 18 and 88 each operate three buses per hour in each direction.



to Lines 12, 18, 62, 88 and 96. This represents a maximum of 5 to 6 riders to any individual bus. Observations show there would be adequate capacity on these buses to accommodate the riders.

Inset 1: Hourly Entries and Exits at Lake Merritt BART Station



Notes:

1. Existing entries and exits are based on BART's Hourly Ridership by Origin-Destination Pairs from a typical weekday in January 2019.
2. Existing plus project volumes apply a conservative scenario where peak hour Modified Project-generated BART volumes are applied to all hours of BART operation. This accurately measures the Project's impact on peak hour operations while over emphasizing the off-peak impact.

Source: Fehr & Peers, 2021

Proposed BART Shuttle Service

As noted above, the Approved Project has required conditions and compliance that would be applied to the Project Modifications, including a written commitment from AC Transit to provide bus service or a private shuttle operations plan that would serve the Project site. The full complement of TDM Measures applicable to Project Modifications are included in Attachment F.

The shuttle service that would be established through the TDM Plan would primarily serve BART riders using the Lake Merritt BART station. Biking between the Project site and the BART station would be faster than using the shuttle bus and so it is assumed that half of the BART riders would bike to the Lake Merritt BART station while the other half would use the shuttle bus. Based on this and the transit trip generation estimates in Table 10, the maximum demand for the shuttle in either direction would be 193 passengers per hour. Assuming a maximum capacity of 30 passengers per



shuttle, serving this maximum demand would require seven roundtrips to be made per hour, which is the equivalent to one trip every 8.5 minutes. Roughly three shuttle buses would need to operate during the peak commute hours to handle 193 passengers per hour⁹.

Water Taxi Service Analysis

Consistent with the Project's goal to provide residents with multi-modal transit options, the Project proposes to establish a dock for an existing water taxi service in the bay area that could serve the Brooklyn Basin Marina and multiple points in San Francisco. If the existing water taxi service in the bay area used the dock it is anticipated that it would operate predetermined on-demand private service between points. At dock opening the on-demand water taxi service is expected to operate only one to two trips during commute hours one to two days a week. Over time and depending on-demand the service could be expanded to every day with up to six round trips per day.

Considering that an estimated 2% of Modified Project-generated trips would be taken by ferry via Jack London Square if water taxi service were not provided, and that water taxi service would provide closer and more convenient service to similar destinations, it is assumed that most Project residents would prefer the water taxi service over ferry service. Thus, water taxi demand would be at least equal to estimated ferry demand. This would result in up to 11 passenger trips per hour during peak periods, in either direction.

Depending on several factors such as travel time, cost, comfort, and frequency, the water taxi service could also be utilized by Project residents who work in San Francisco, but who would have otherwise utilized BART for their commute. From Table 10, the maximum BART demand in either direction is 385 trips per hour, and these trips would be approximately equally distributed to BART stations at major job centers: Downtown Berkeley, Embarcadero, Montgomery Street, Powell Street, and Civic Center/UN Plaza stations. If only residents traveling to and from the Embarcadero station area would utilize the water taxi service, the peak demand in either direction would be 77 passenger trips per hour.

Accounting for trips converted from both ferry and BART ridership, the total maximum demand for water taxi service in either direction would be roughly 88 passenger trips per hour. The water taxi capacity is 43 passengers, thus about two hourly round trips would be necessary to accommodate this estimated maximum demand.

⁹ A single round trip includes 8 minutes travel time each way plus 5 minutes for (un)loading at each trip end for a total round-trip travel time of 26 minutes. Based on this time 3 shuttle buses are required to maintain 8.5-minute headways.



Table 11 compares the estimated travel times, via BART and water taxi, between Brooklyn Basin and the San Francisco Ferry Building. Travel time estimates do not include the time required to walk from an individual’s residence to the shuttle stop or water taxi dock, which varies depending on location of the residence within the Project site.

Table 11: Travel Time Comparison: Water Taxi vs. BART

Trip Mode	AM/PM Peak Period Travel Time ¹
Water Taxi ²	35 minutes
BART ³	30 minutes

Notes:

1. Travel times for each mode are equal in both the AM and PM peak period and are not impacted by directionality (i.e. westbound vs. eastbound).
2. The current ferry travel time between Jack London Square and San Francisco is 25 minutes. 10 minutes are added to this time to estimate the water taxi service time, based on the increased 0.5-mile travel distance to the Brooklyn Basin Marina and the usage of smaller, less powerful boats.
3. BART travel times include estimated bus shuttle travel time to Lake Merritt BART, travel time on BART to Embarcadero Station, and average walking time from Embarcadero Station to the San Francisco Ferry Building. Without the bus shuttle the total travel time for BART would increase to 40 minutes.

Source: Fehr & Peers, 2021

Assuming parameters mentioned above, trips made via BART could be made 5 minutes quicker than those made via water taxi. Other factors, such as the specific location of a passengers’ residence within the Project site, transit schedules, and service disruptions have the potential to impact travel times, and therefore mode choice. Ultimately, project residents will choose transit service based on end-to-end travel time, comfort, affordability, and other preferences.

Railroad Crossing

The railroad operations were evaluated in the SEIR in the context of providing adequate emergency vehicle access to the site. The SEIR noted that railroad gate down times at the 5th Avenue crossing were highly variable and that freight trains do not operate on a fixed schedule. As noted in the SEIR, when a freight train is blocking 5th Avenue, access to the project site is limited and would be a temporary inconvenience to motor vehicle traffic as well as bicyclists and pedestrians. However, a blockage would be more serious issue for an emergency vehicle traveling to and from the site. The SEIR noted that there are available alternative routes to access the site including Oak Street (to the north) and the overcrossing on 16th Avenue (to the south) and so did not find a significant impact for emergency vehicle access.



The SEIR established that the Approved Project had a significant impact at the Embarcadero intersection with 5th Avenue. Mitigation Measure B.1d required installation of traffic signals at the intersection and that the installations would meet City of Oakland and Caltrans design standards. This mitigation measure triggered a Diagnostic Review of the at-grade railroad crossing including a GO 88-B Request (Authorization to Alter Highway Rail Crossings) with the CPUC. As a result of this request, the traffic signal installation was expanded to also included upgraded railroad crossing safety features such as new gates, pedestrian and bicycle facilities, pre-traffic signals, and railroad traffic signal preemption. This work was completed in late 2019. The Project Modifications would not change the nature of the railroad crossings at 5th Avenue and so no additional improvements beyond those approved by the City of Oakland and the CPUC are recommended at this time.

Figures

Figure 1: Project Modification Study Area

Figure 2: Project Modification Trip Distribution

Figure 3: Project Modification Trip Assignment

Attachments

Attachment A: 2018 Intersection Traffic Counts

Attachment B: Intersection Analysis LOS Worksheets

Attachment C: Peak Hour Volumes and Lane Configurations

Attachment D: HCM Predicted Collision Frequency Sheets

Attachment E: Congestion Management Program Analysis Worksheets

Attachment F: TDM Plan Recommendations



N:\Projects\2018\OK18-0295.00_Brooklyn_Basin_Density\Graphics\GIS\MXD\18-0295.00_TripGen_Figure.mxd

- ++++ Railroad
- City Boundary
- Surface Water
- ▭ Project Site
- Park



Project Modification Study Area

Figure 1



N:\Projects\2018\OK18-0295.00_Brooklyn_Basin_Density\Graphics\GIS\MXD\18-0295.00_TripGen_Figure.mxd

- ++++ Railroad
- City Boundary
- Surface Water
- ▭ Project Site
- Park
- ##% Project Trip Distribution



Project Modification Trip Distribution

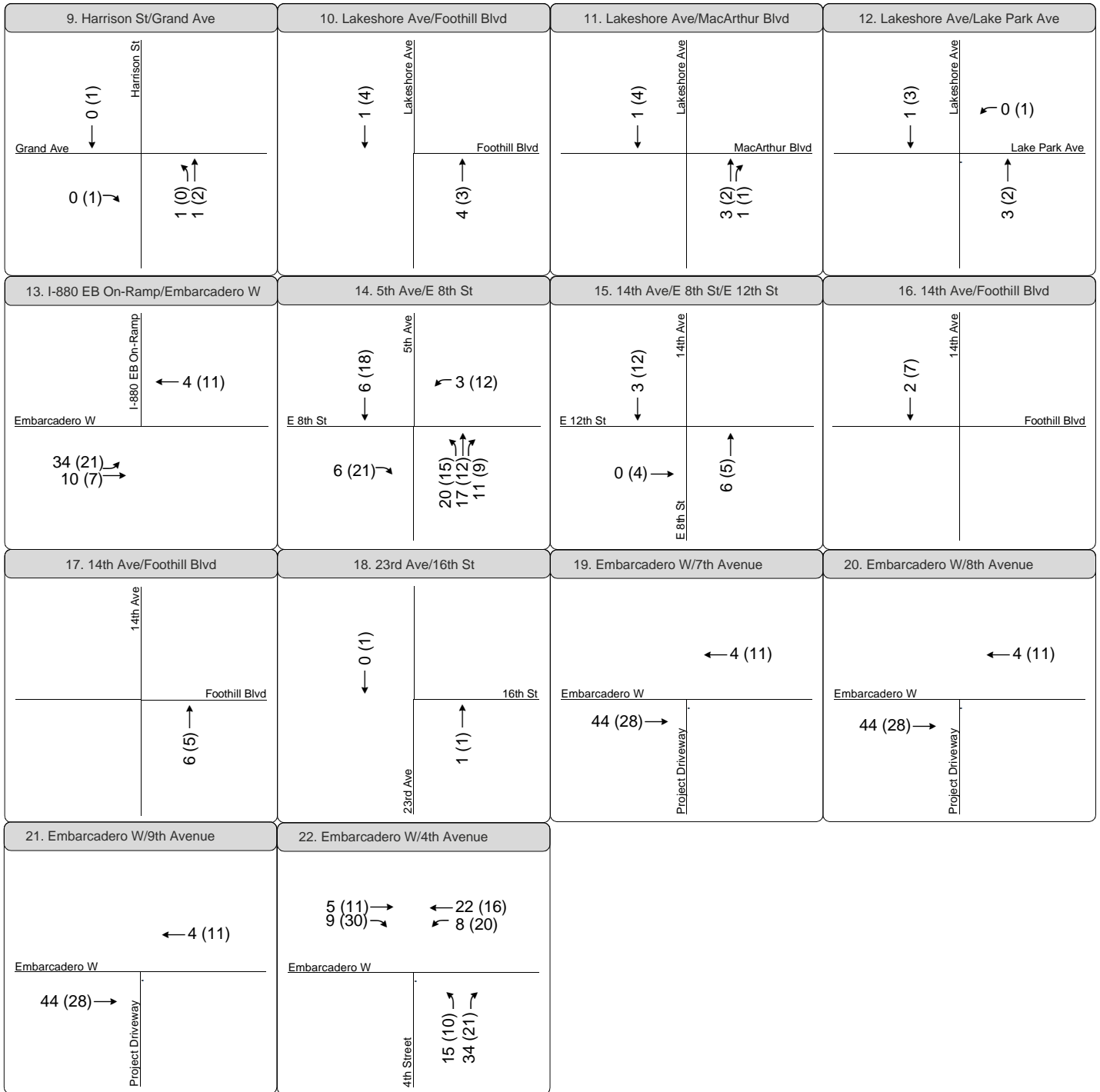
Figure 2



1. Oak St/Embarcadero W/Embarcadero W	2. Broadway/5th St	3. Jackson St/6th St	4. 5th Ave/Embarcadero W								
				5. I-880 WB Off-Ramp/Embarcadero W	6. Webster St/Atlantic Ave	7. Broadway/Embarcadero W	8. Oak St/5th St				
5. I-880 WB Off-Ramp/Embarcadero W	6. Webster St/Atlantic Ave	7. Broadway/Embarcadero W	8. Oak St/5th St								

Project Modification Trip Assignment

Figure 3



Project Modification Trip Assignment

Figure 3

Attachment A

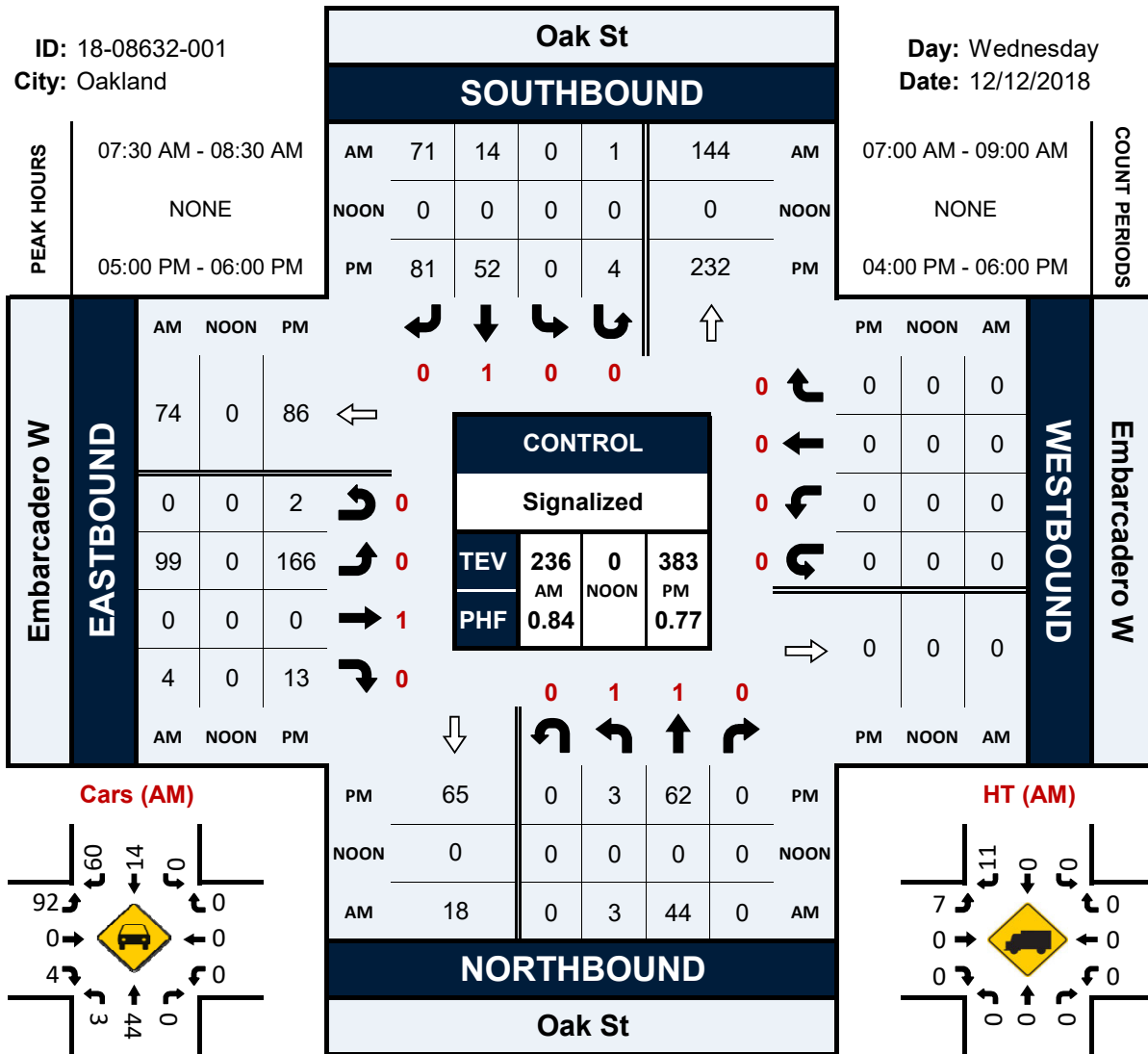
2018 Intersection Traffic Counts

Oak St & Embarcadero W

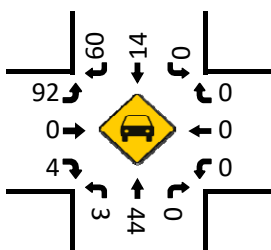
Peak Hour Turning Movement Count

ID: 18-08632-001
City: Oakland

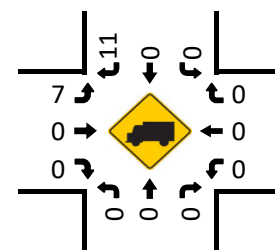
Day: Wednesday
Date: 12/12/2018



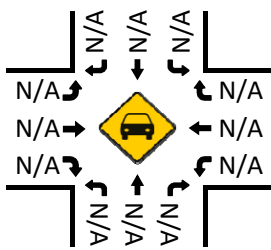
Cars (AM)



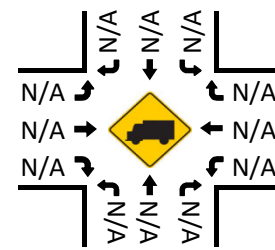
HT (AM)



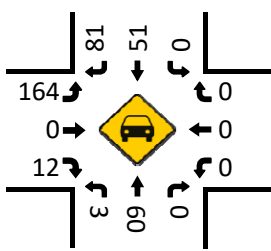
Cars (NOON)



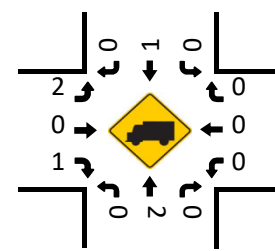
HT (NOON)



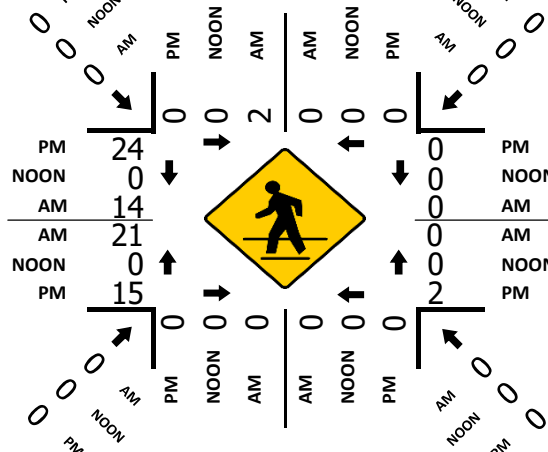
Cars (PM)



HT (PM)



Pedestrians (Crosswalks)

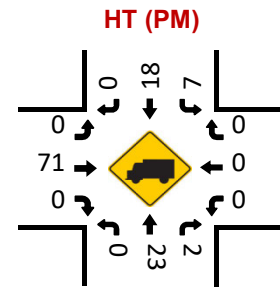
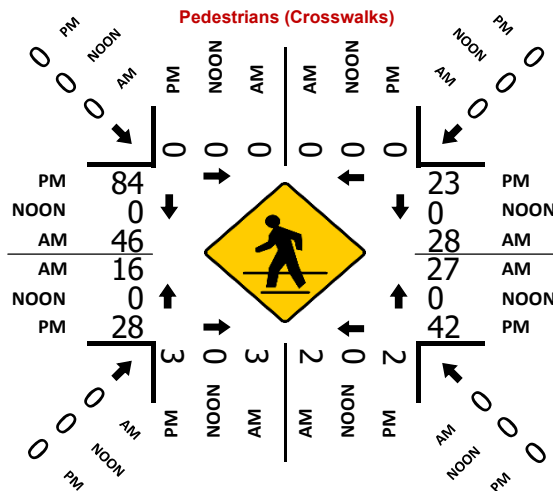
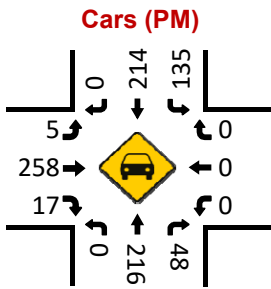
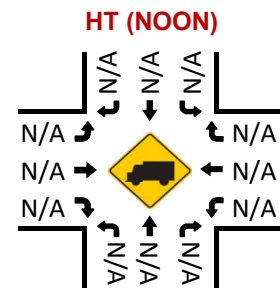
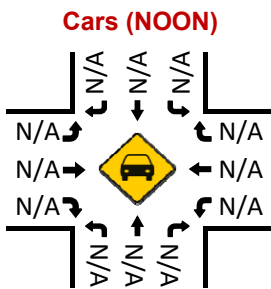
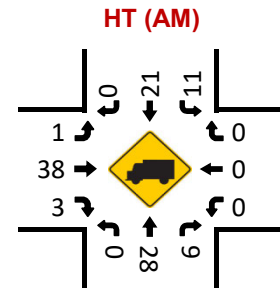
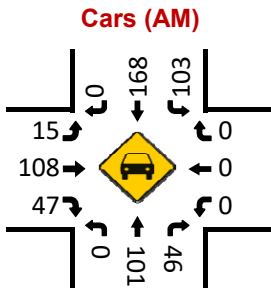
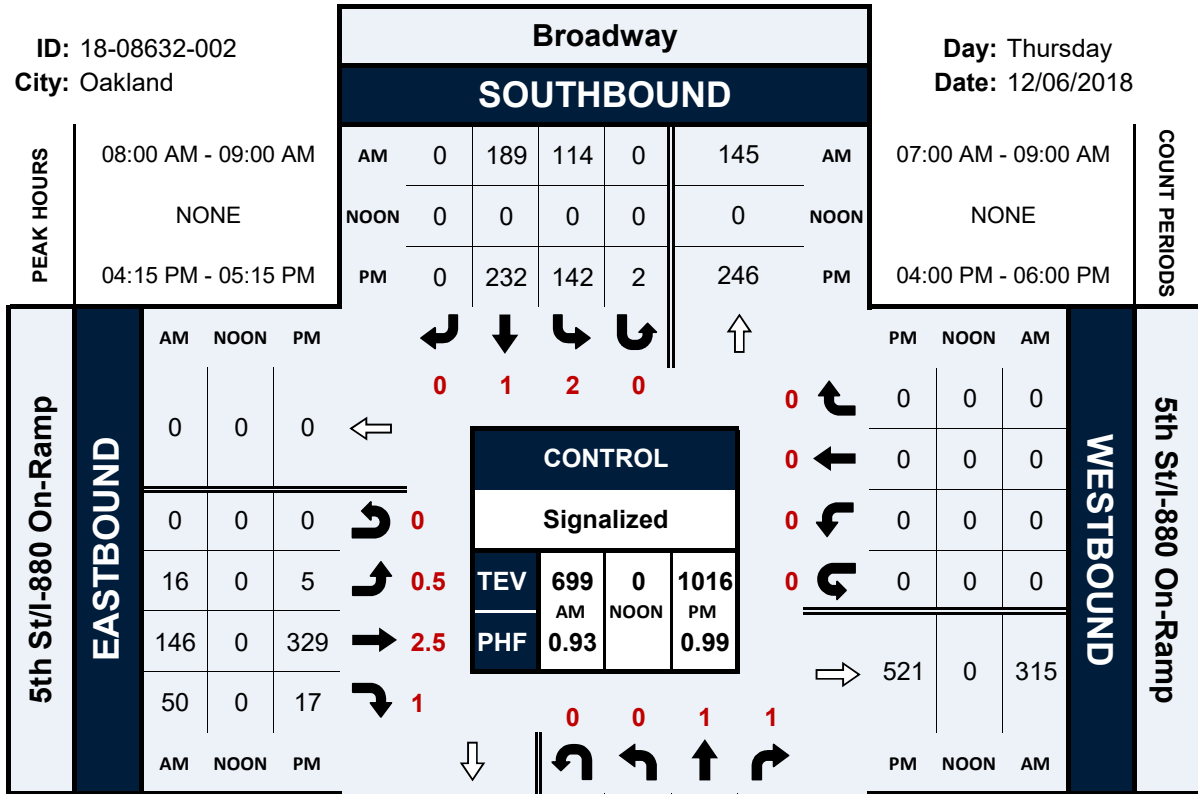


Broadway & 5th St/I-880 On-Ramp

Peak Hour Turning Movement Count

ID: 18-08632-002
City: Oakland

Day: Thursday
Date: 12/06/2018

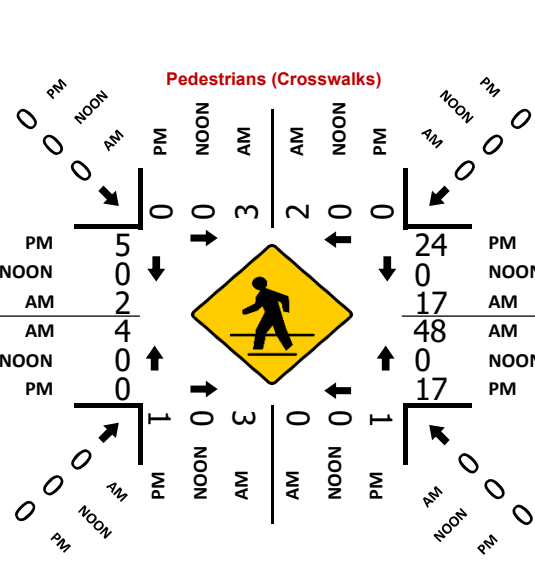
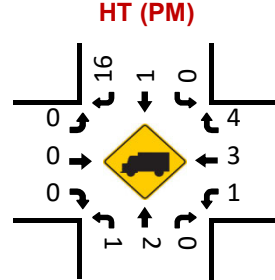
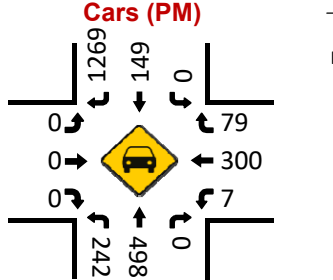
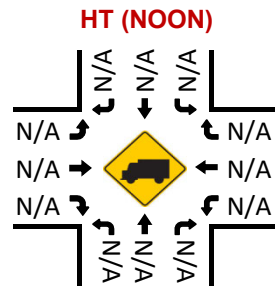
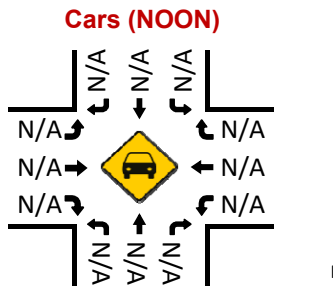
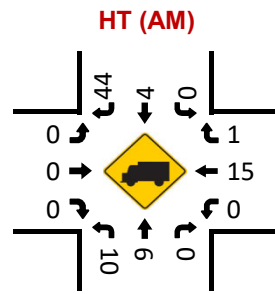
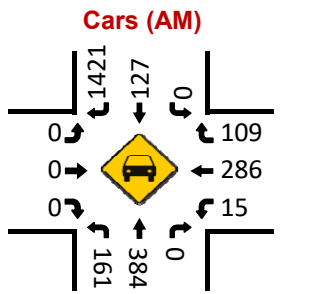
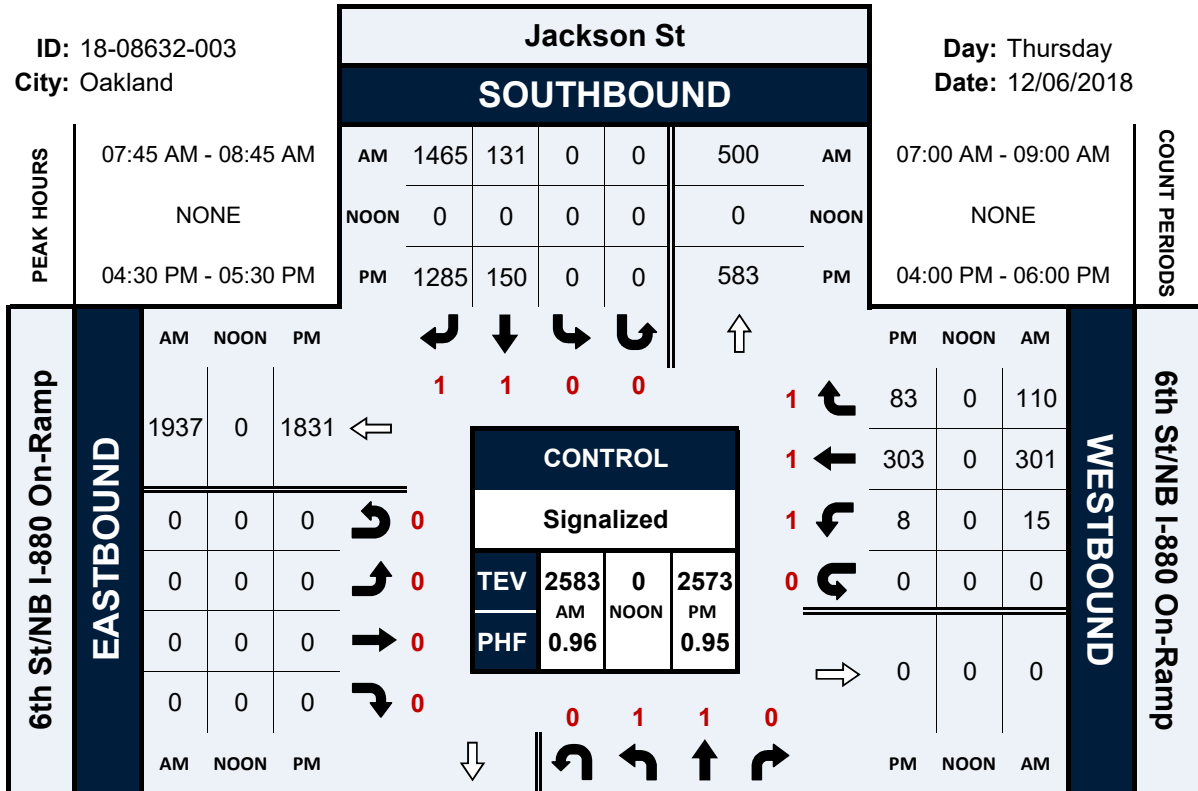


Jackson St & 6th St/NB I-880 On-Ramp

Peak Hour Turning Movement Count

ID: 18-08632-003
City: Oakland

Day: Thursday
Date: 12/06/2018

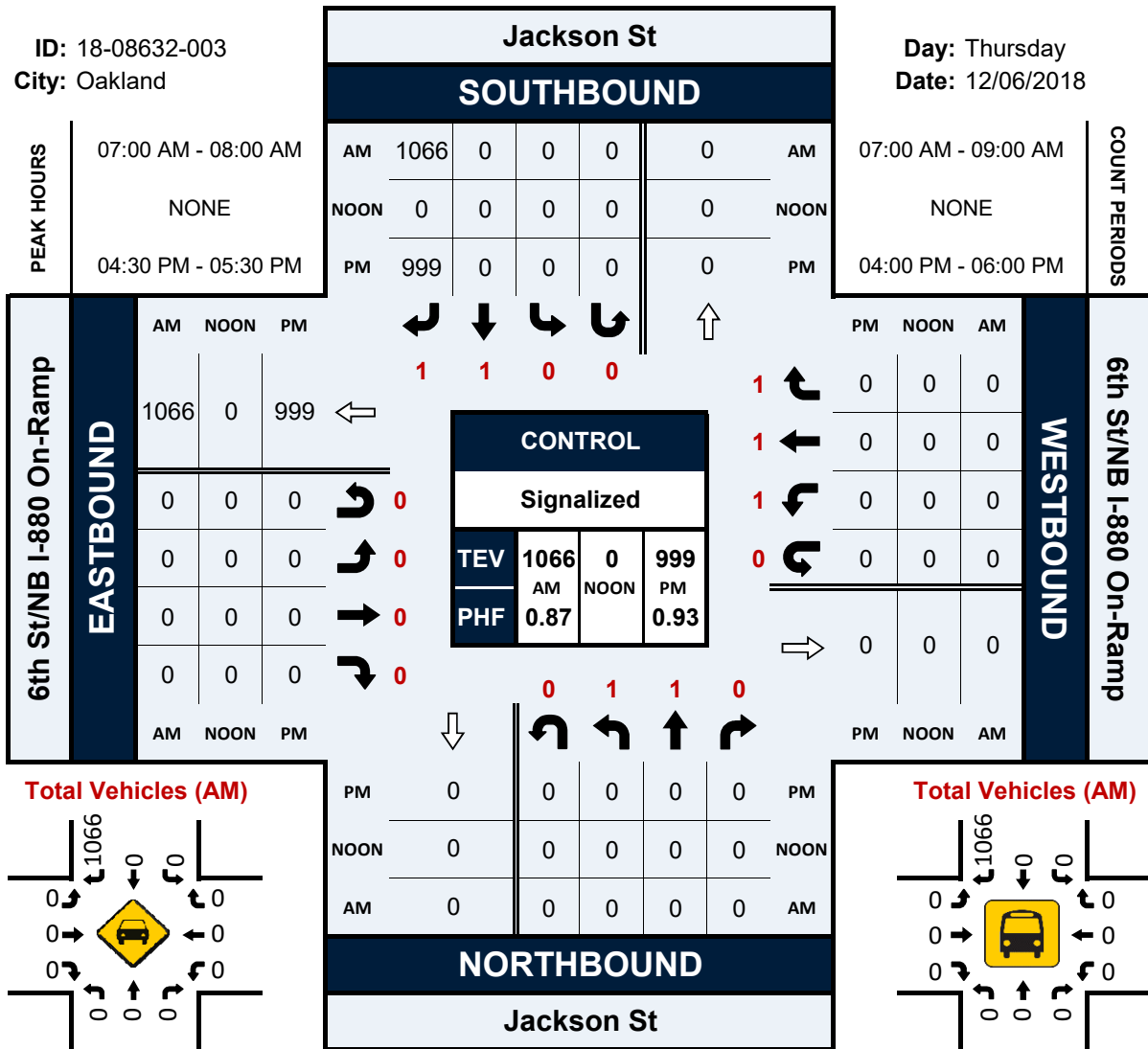


Jackson St & 6th St/NB I-880 On-Ramp

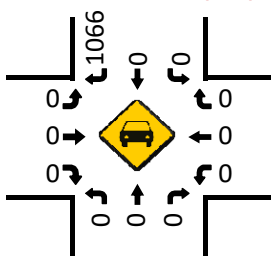
Peak Hour Turning Movement Count

ID: 18-08632-003
City: Oakland

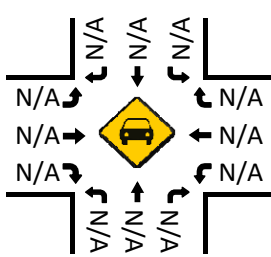
Day: Thursday
Date: 12/06/2018



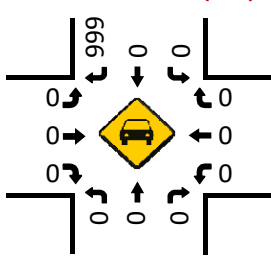
Total Vehicles (AM)



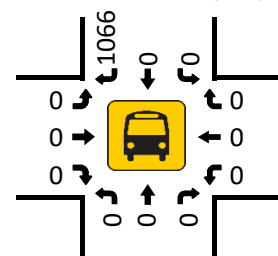
Total Vehicles (NOON)



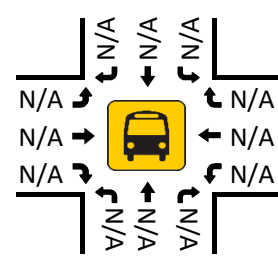
Total Vehicles (PM)



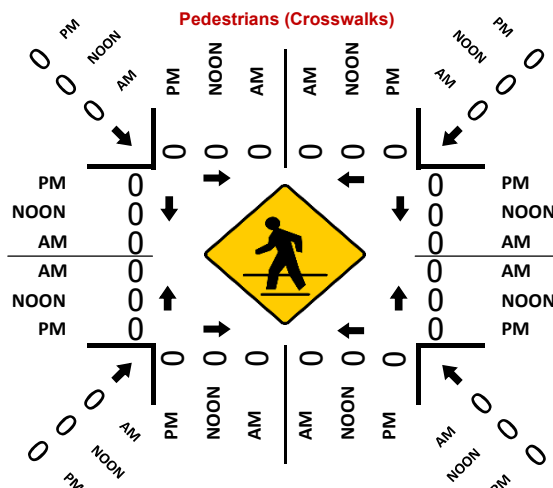
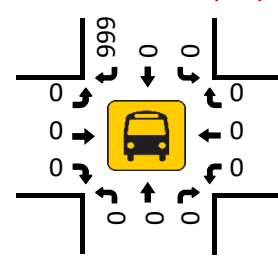
Total Vehicles (AM)



Total Vehicles (NOON)



Total Vehicles (PM)

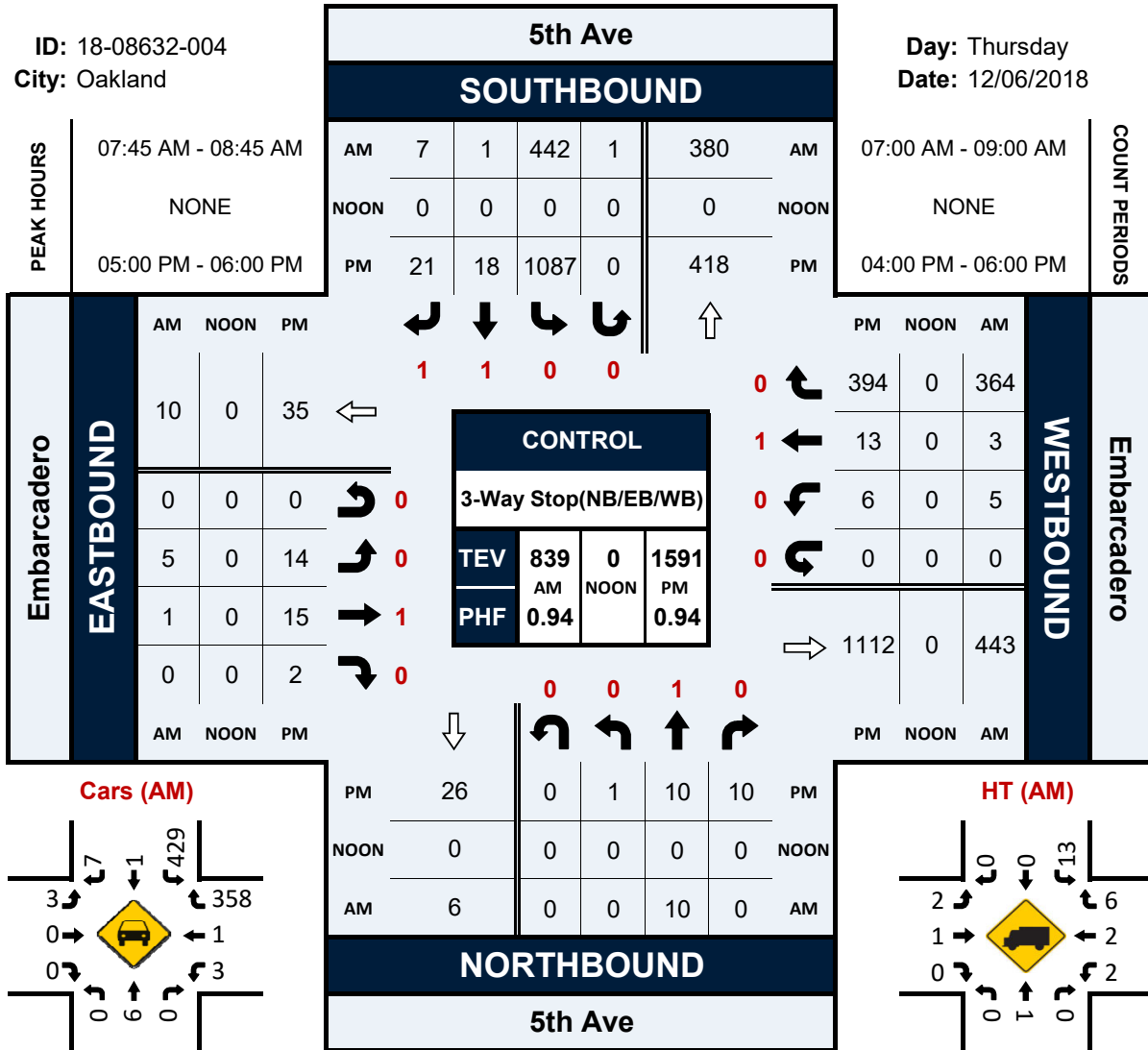


5th Ave & Embarcadero

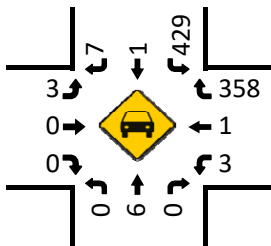
Peak Hour Turning Movement Count

ID: 18-08632-004
City: Oakland

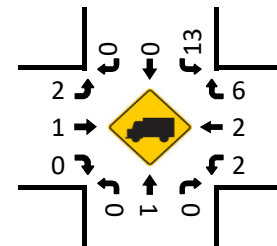
Day: Thursday
Date: 12/06/2018



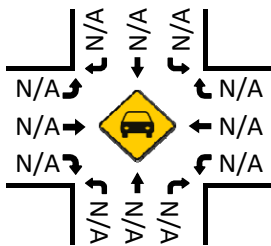
Cars (AM)



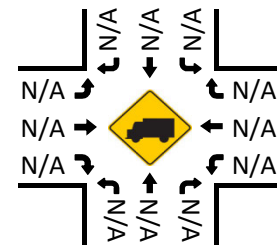
HT (AM)



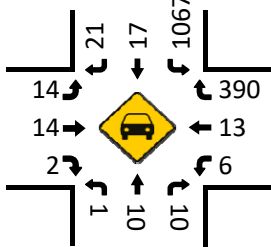
Cars (NOON)



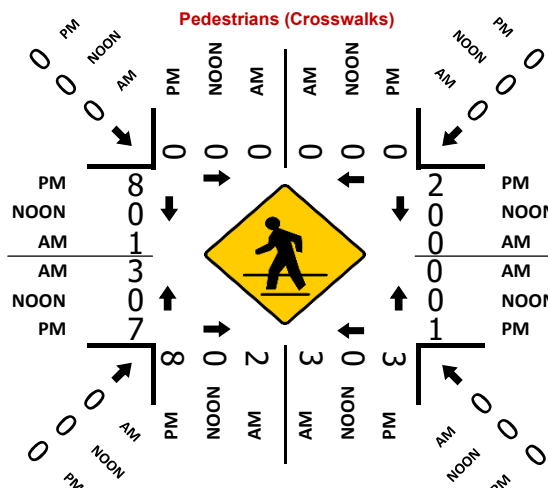
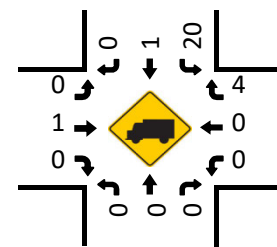
HT (NOON)



Cars (PM)



HT (PM)

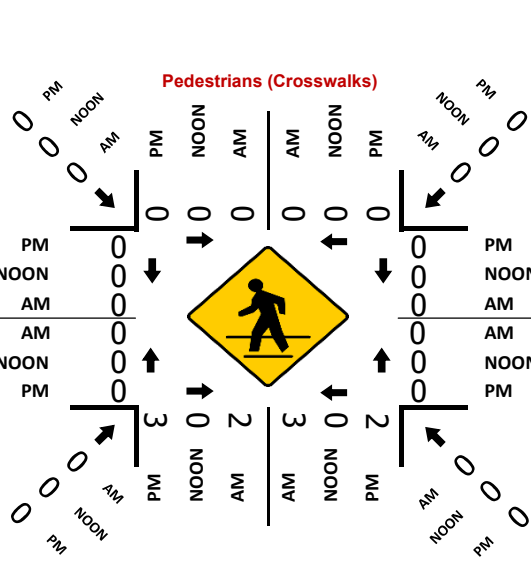
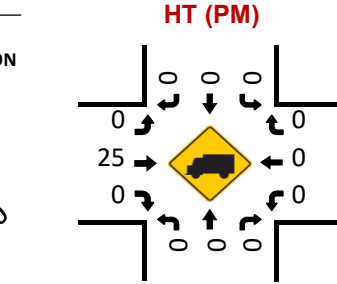
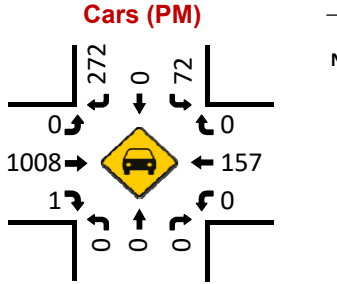
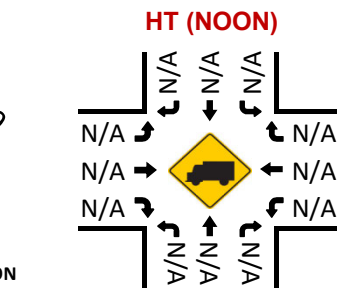
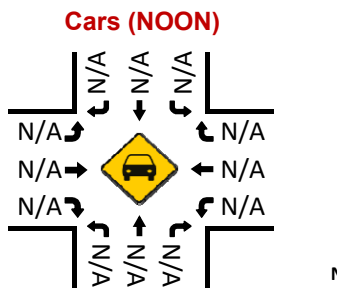
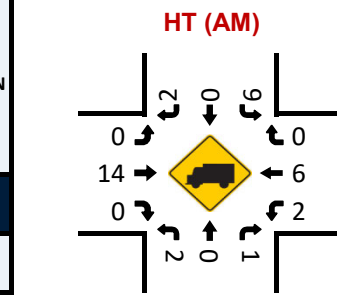
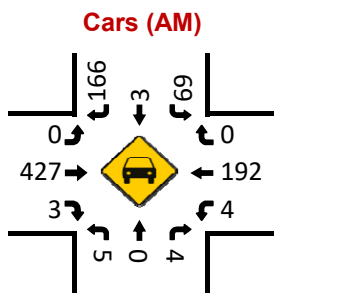
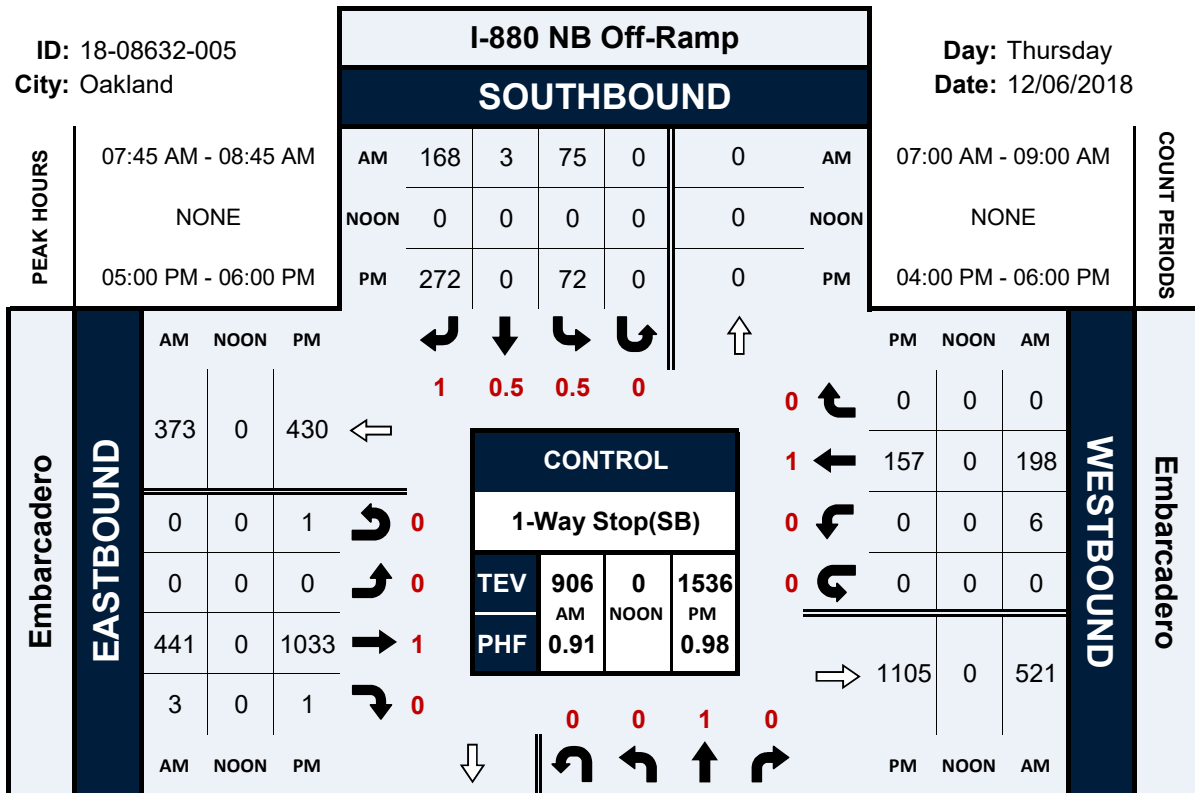


I-880 NB Off-Ramp & Embarcadero

Peak Hour Turning Movement Count

ID: 18-08632-005
City: Oakland

Day: Thursday
Date: 12/06/2018

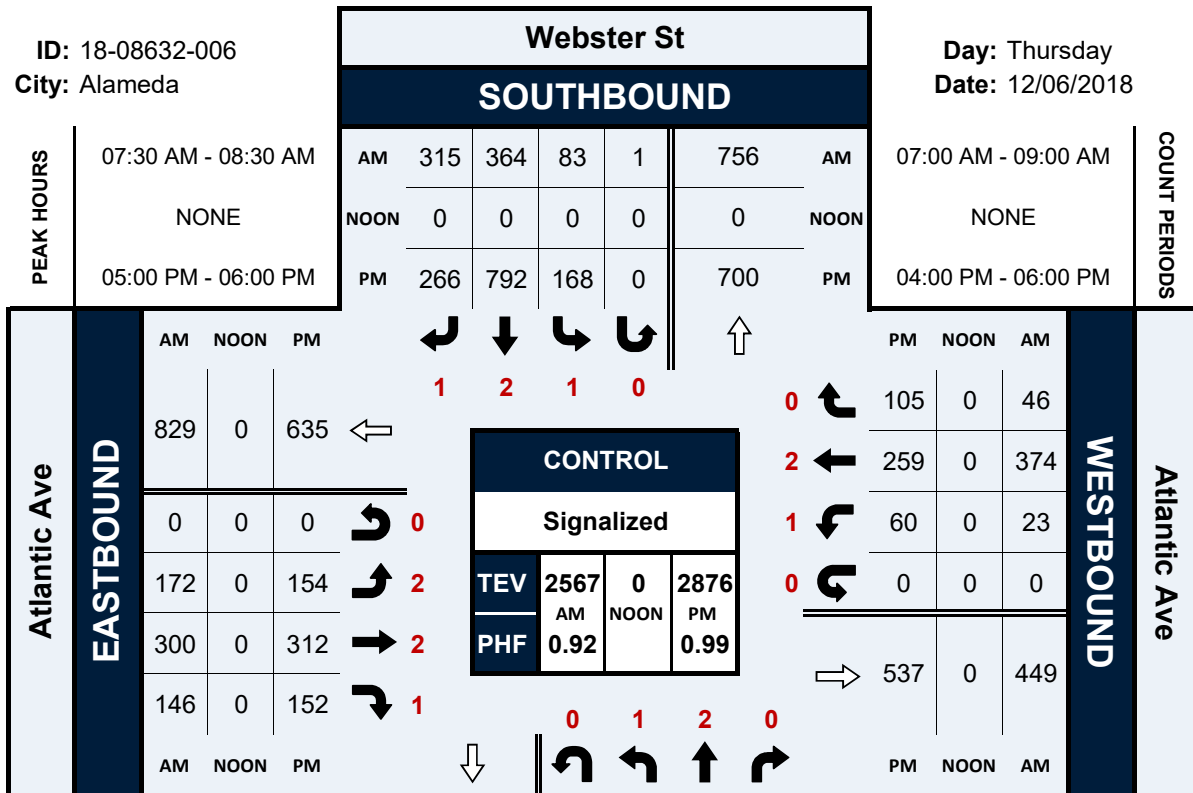


Webster St & Atlantic Ave

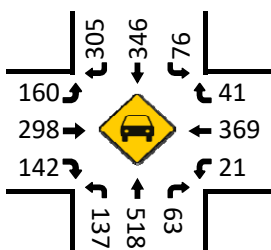
Peak Hour Turning Movement Count

ID: 18-08632-006
City: Alameda

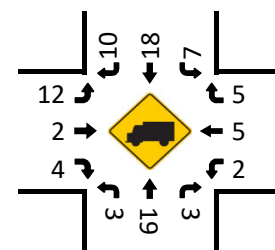
Day: Thursday
Date: 12/06/2018



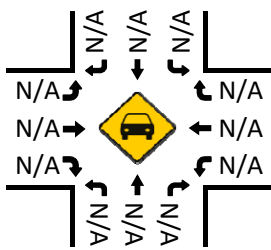
Cars (AM)



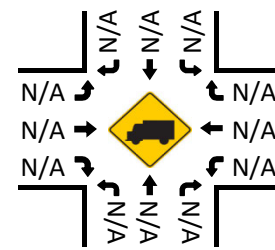
HT (AM)



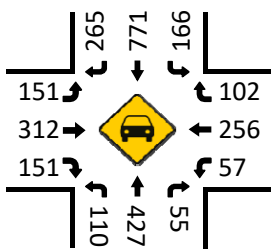
Cars (NOON)



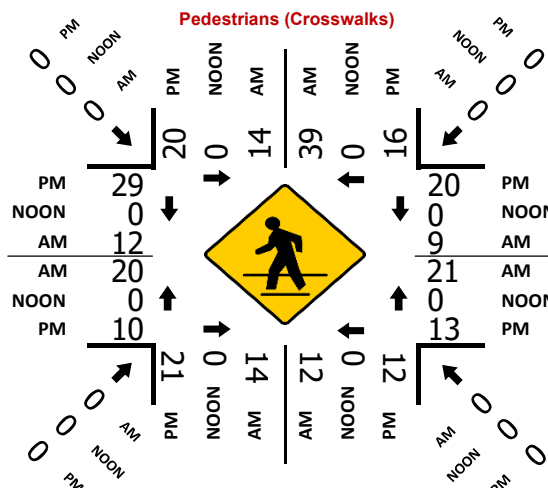
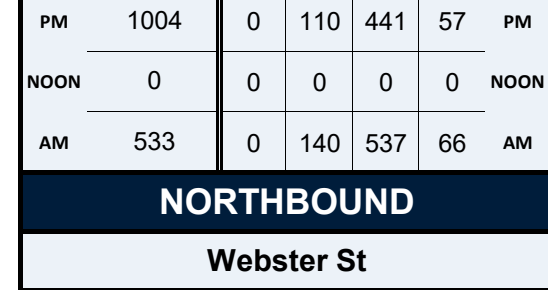
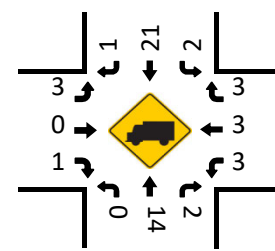
HT (NOON)



Cars (PM)



HT (PM)

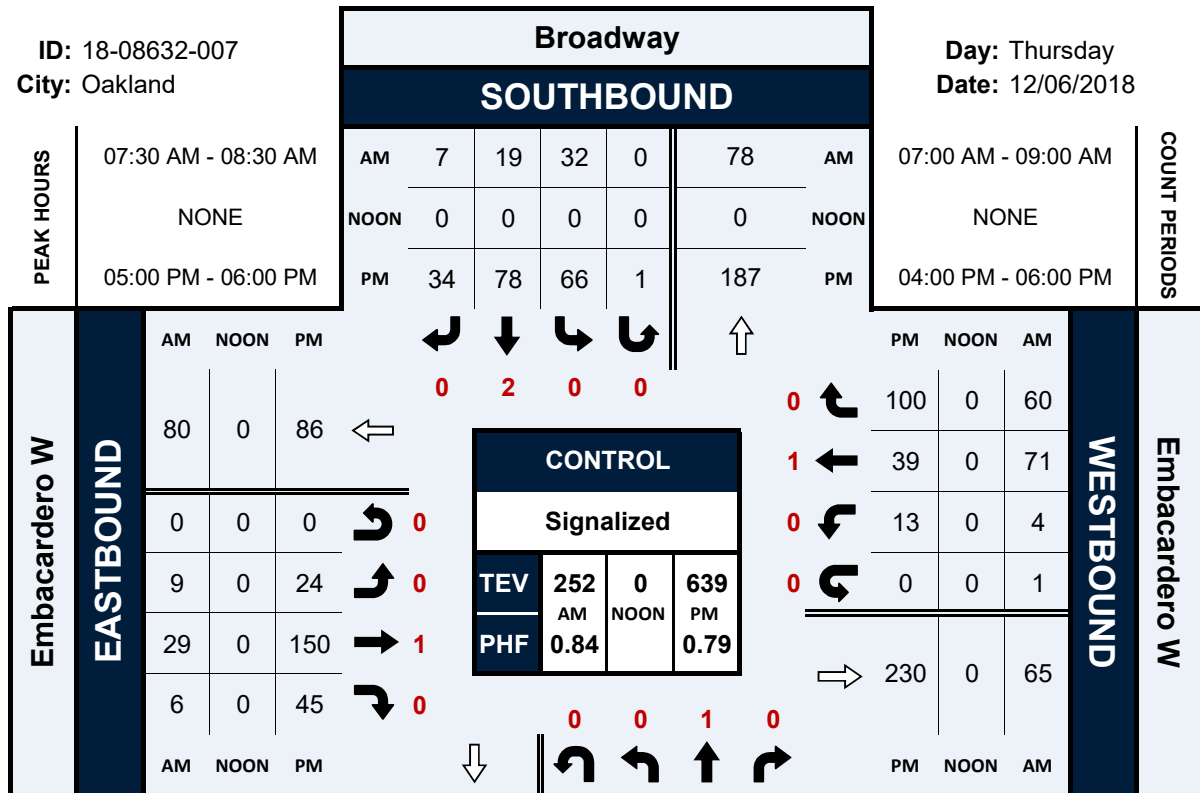


Broadway & Embacardero W

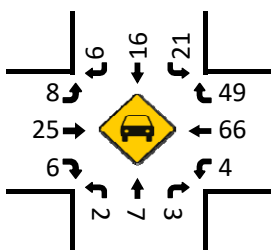
Peak Hour Turning Movement Count

ID: 18-08632-007
City: Oakland

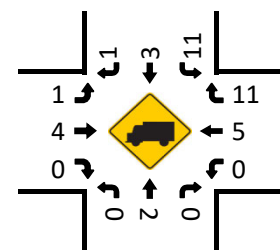
Day: Thursday
Date: 12/06/2018



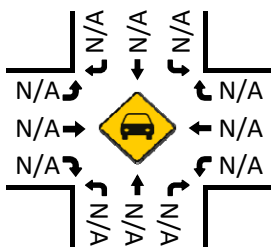
Cars (AM)



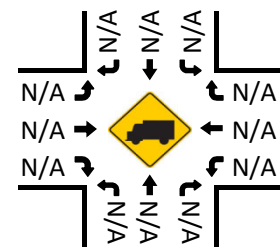
HT (AM)



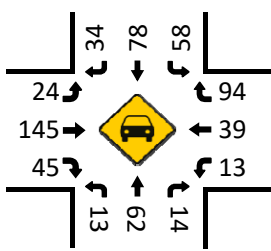
Cars (NOON)



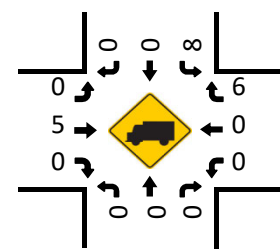
HT (NOON)



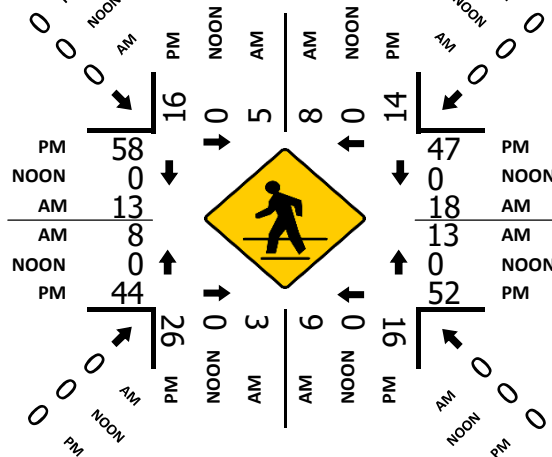
Cars (PM)



HT (PM)



Pedestrians (Crosswalks)

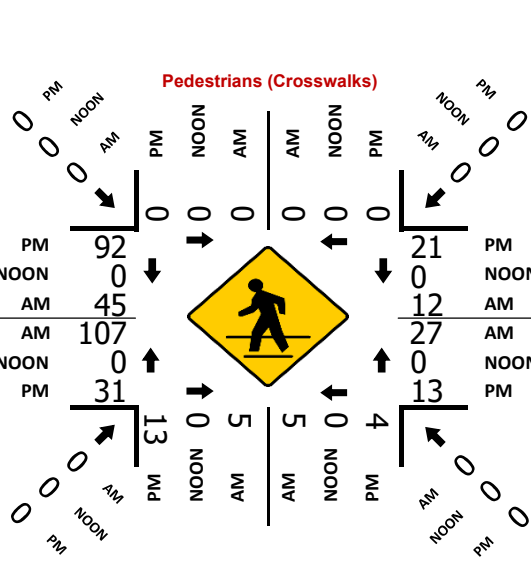
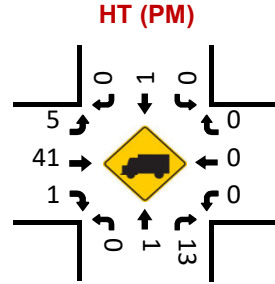
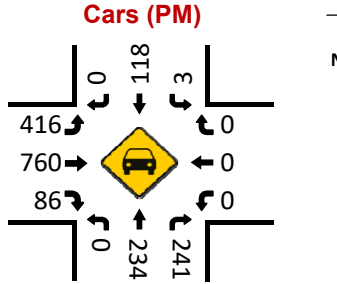
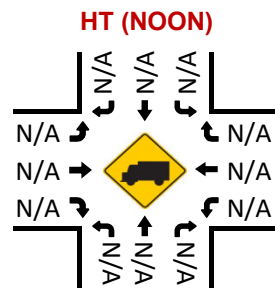
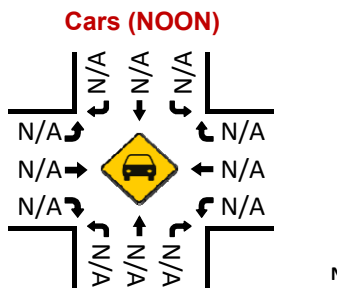
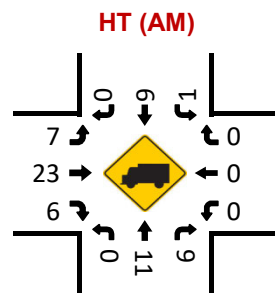
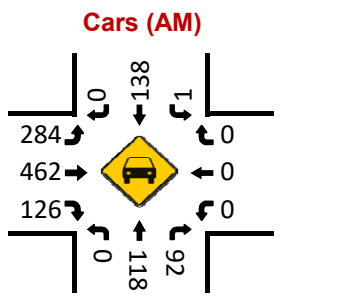
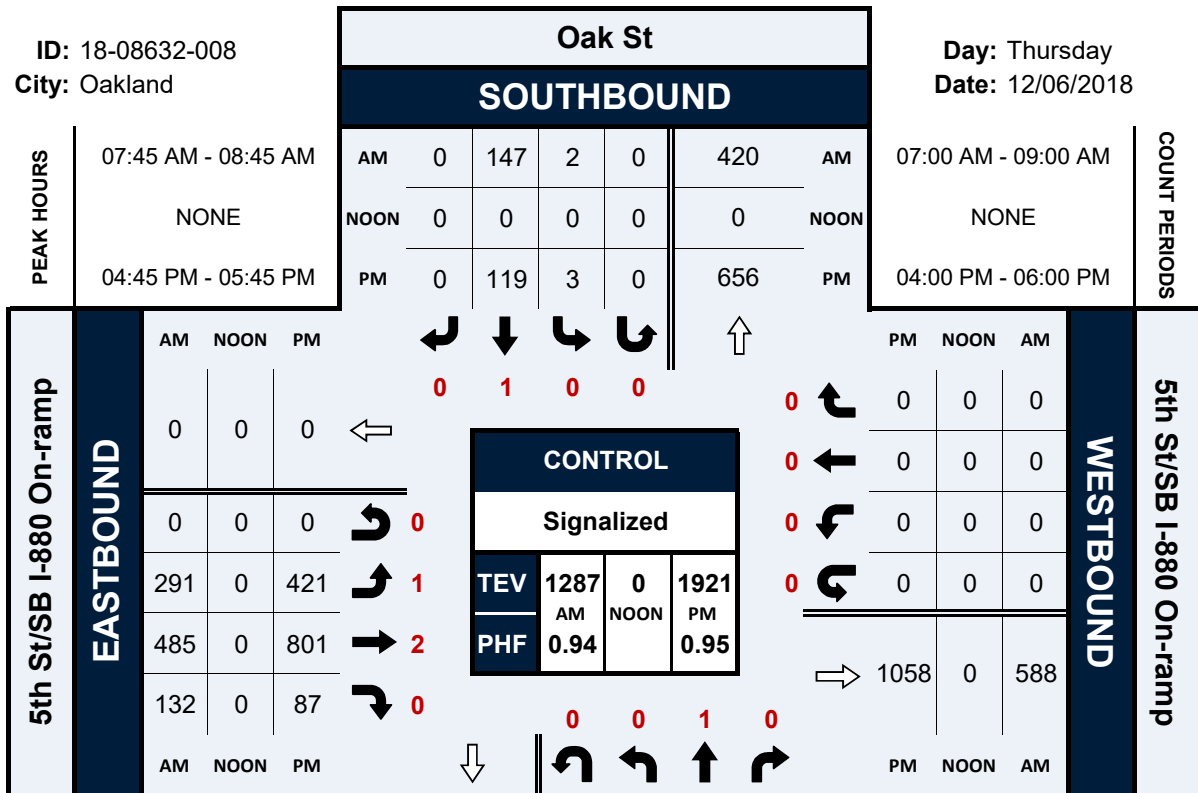


Oak St & 5th St/SB I-880 On-ramp

Peak Hour Turning Movement Count

ID: 18-08632-008
City: Oakland

Day: Thursday
Date: 12/06/2018

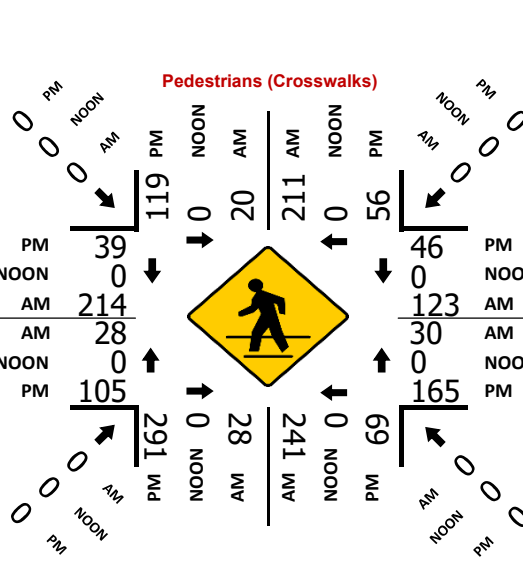
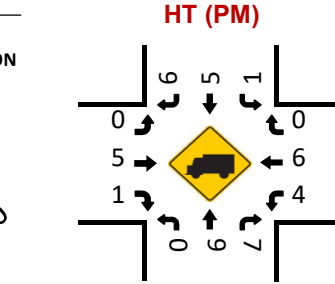
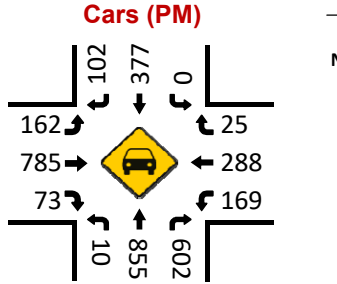
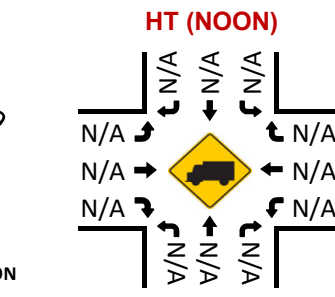
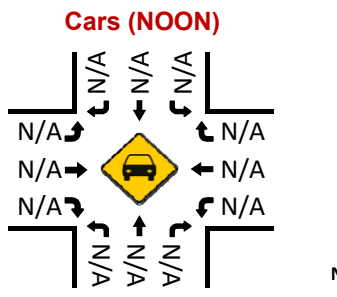
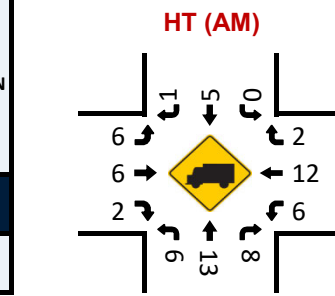
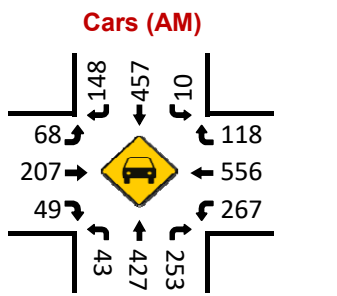
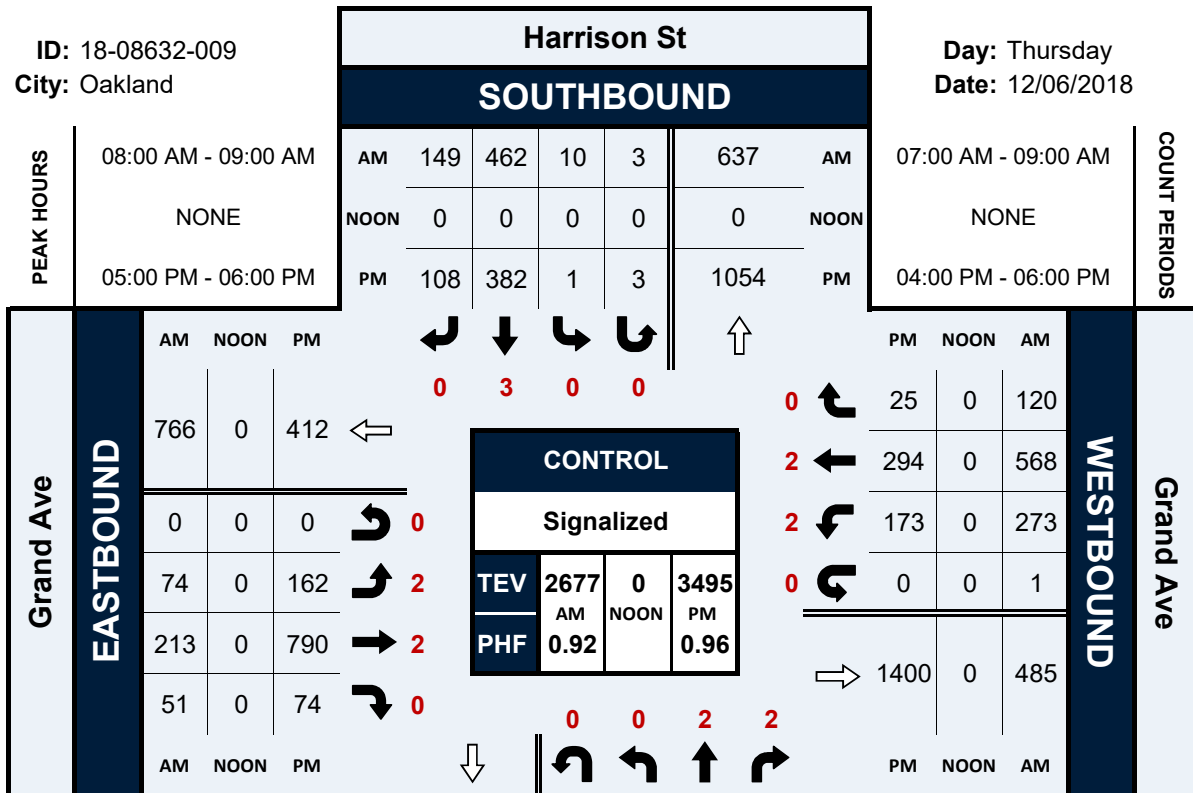


Harrison St & Grand Ave

Peak Hour Turning Movement Count

ID: 18-08632-009
City: Oakland

Day: Thursday
Date: 12/06/2018



Lakeshore Ave & Foothill Blvd

Peak Hour Turning Movement Count

ID: 18-08632-010

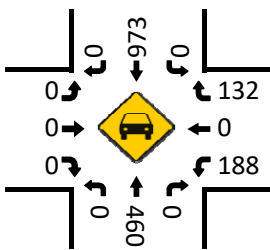
City: Oakland

Day: Thursday

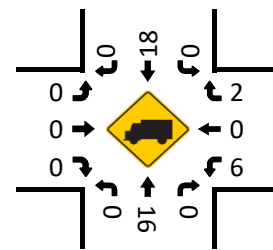
Date: 12/06/2018

PEAK HOURS		Lakeshore Ave						COUNT PERIODS																																
		SOUTHBOUND																																						
PEAK HOURS	07:45 AM - 08:45 AM	AM	0	991	0	0	610	AM	07:00 AM - 09:00 AM	COUNT PERIODS																														
	NONE	NOON	0	0	0	0	0	NOON																																
	04:45 PM - 05:45 PM	PM	0	669	0	0	1259	PM																																
<table border="1"> <thead> <tr> <th colspan="3">CONTROL</th> </tr> <tr> <th colspan="3">Signalized</th> </tr> <tr> <th>TEV</th> <th>1795</th> <th>0</th> <th>2039</th> </tr> <tr> <td></td> <td>AM</td> <td>NOON</td> <td>PM</td> </tr> <tr> <th>PHF</th> <th>0.95</th> <th></th> <th>0.97</th> </tr> </thead> </table>											CONTROL			Signalized			TEV	1795	0	2039		AM	NOON	PM	PHF	0.95		0.97												
CONTROL																																								
Signalized																																								
TEV	1795	0	2039																																					
	AM	NOON	PM																																					
PHF	0.95		0.97																																					
<table border="1"> <thead> <tr> <th>AM</th> <th>NOON</th> <th>PM</th> <th>AM</th> <th>NOON</th> <th>PM</th> </tr> </thead> <tbody> <tr> <td>0</td><td>0</td><td>0</td><td>0</td><td>0</td><td>0</td> </tr> <tr> <td>0</td><td>0</td><td>0</td><td>0</td><td>0</td><td>0</td> </tr> <tr> <td>0</td><td>0</td><td>0</td><td>0</td><td>0</td><td>0</td> </tr> <tr> <td>0</td><td>0</td><td>0</td><td>0</td><td>0</td><td>0</td> </tr> </tbody> </table>											AM	NOON	PM	AM	NOON	PM	0	0	0	0	0	0	0	0	0	0	0	0	0	0	0	0	0	0	0	0	0	0	0	0
AM	NOON	PM	AM	NOON	PM																																			
0	0	0	0	0	0																																			
0	0	0	0	0	0																																			
0	0	0	0	0	0																																			
0	0	0	0	0	0																																			
<table border="1"> <thead> <tr> <th>PM</th> <th>NOON</th> <th>AM</th> <th>PM</th> <th>NOON</th> <th>AM</th> </tr> </thead> <tbody> <tr> <td>83</td><td>0</td><td>134</td><td>0</td><td>0</td><td>0</td> </tr> <tr> <td>0</td><td>0</td><td>0</td><td>111</td><td>0</td><td>194</td> </tr> <tr> <td>0</td><td>0</td><td>0</td><td>0</td><td>0</td><td>0</td> </tr> <tr> <td>0</td><td>0</td><td>0</td><td>0</td><td>0</td><td>0</td> </tr> </tbody> </table>											PM	NOON	AM	PM	NOON	AM	83	0	134	0	0	0	0	0	0	111	0	194	0	0	0	0	0	0	0	0	0	0	0	0
PM	NOON	AM	PM	NOON	AM																																			
83	0	134	0	0	0																																			
0	0	0	111	0	194																																			
0	0	0	0	0	0																																			
0	0	0	0	0	0																																			
<table border="1"> <thead> <tr> <th>AM</th> <th>NOON</th> <th>PM</th> <th>AM</th> <th>NOON</th> <th>PM</th> </tr> </thead> <tbody> <tr> <td>780</td><td>0</td><td>0</td><td>1176</td><td>0</td><td>0</td> </tr> <tr> <td>0</td><td>0</td><td>0</td><td>0</td><td>0</td><td>0</td> </tr> <tr> <td>1185</td><td>0</td><td>0</td><td>476</td><td>0</td><td>0</td> </tr> </tbody> </table>											AM	NOON	PM	AM	NOON	PM	780	0	0	1176	0	0	0	0	0	0	0	0	1185	0	0	476	0	0						
AM	NOON	PM	AM	NOON	PM																																			
780	0	0	1176	0	0																																			
0	0	0	0	0	0																																			
1185	0	0	476	0	0																																			
<table border="1"> <thead> <tr> <th colspan="6">Lakeshore Ave</th> </tr> <tr> <th colspan="6">NORTHBOUND</th> </tr> </thead> <tbody> <tr> <td>PM</td><td>0</td><td>0</td><td>0</td><td>0</td><td>PM</td> </tr> <tr> <td>NOON</td><td>0</td><td>0</td><td>0</td><td>0</td><td>NOON</td> </tr> <tr> <td>AM</td><td>0</td><td>0</td><td>0</td><td>0</td><td>AM</td> </tr> </tbody> </table>											Lakeshore Ave						NORTHBOUND						PM	0	0	0	0	PM	NOON	0	0	0	0	NOON	AM	0	0	0	0	AM
Lakeshore Ave																																								
NORTHBOUND																																								
PM	0	0	0	0	PM																																			
NOON	0	0	0	0	NOON																																			
AM	0	0	0	0	AM																																			

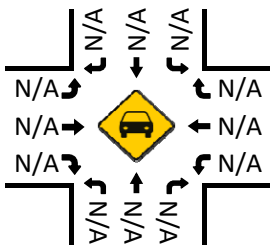
Cars (AM)



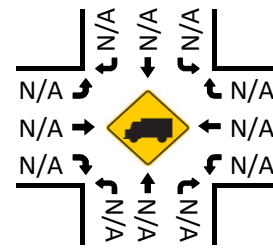
HT (AM)



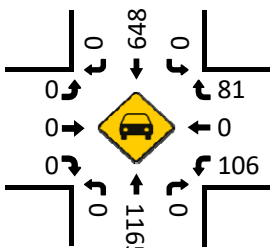
Cars (NOON)



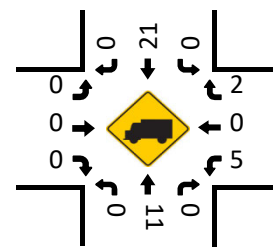
HT (NOON)



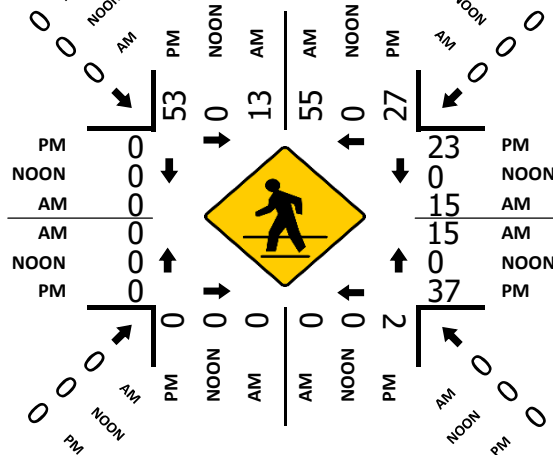
Cars (PM)



HT (PM)



Pedestrians (Crosswalks)

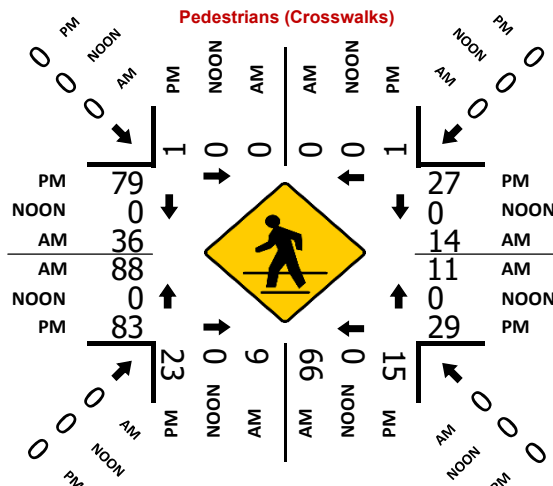
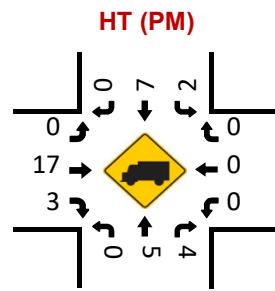
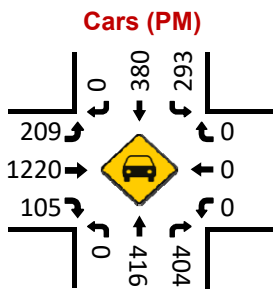
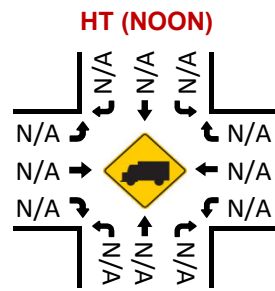
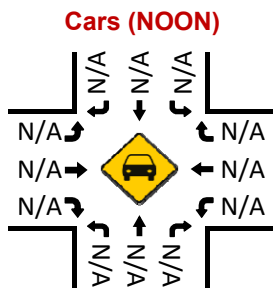
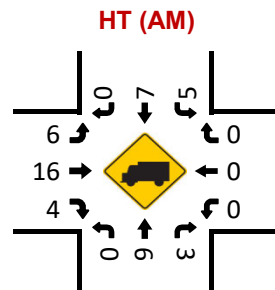
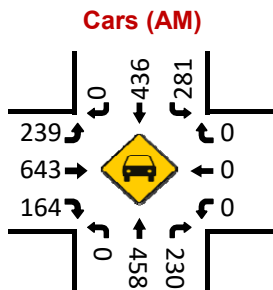
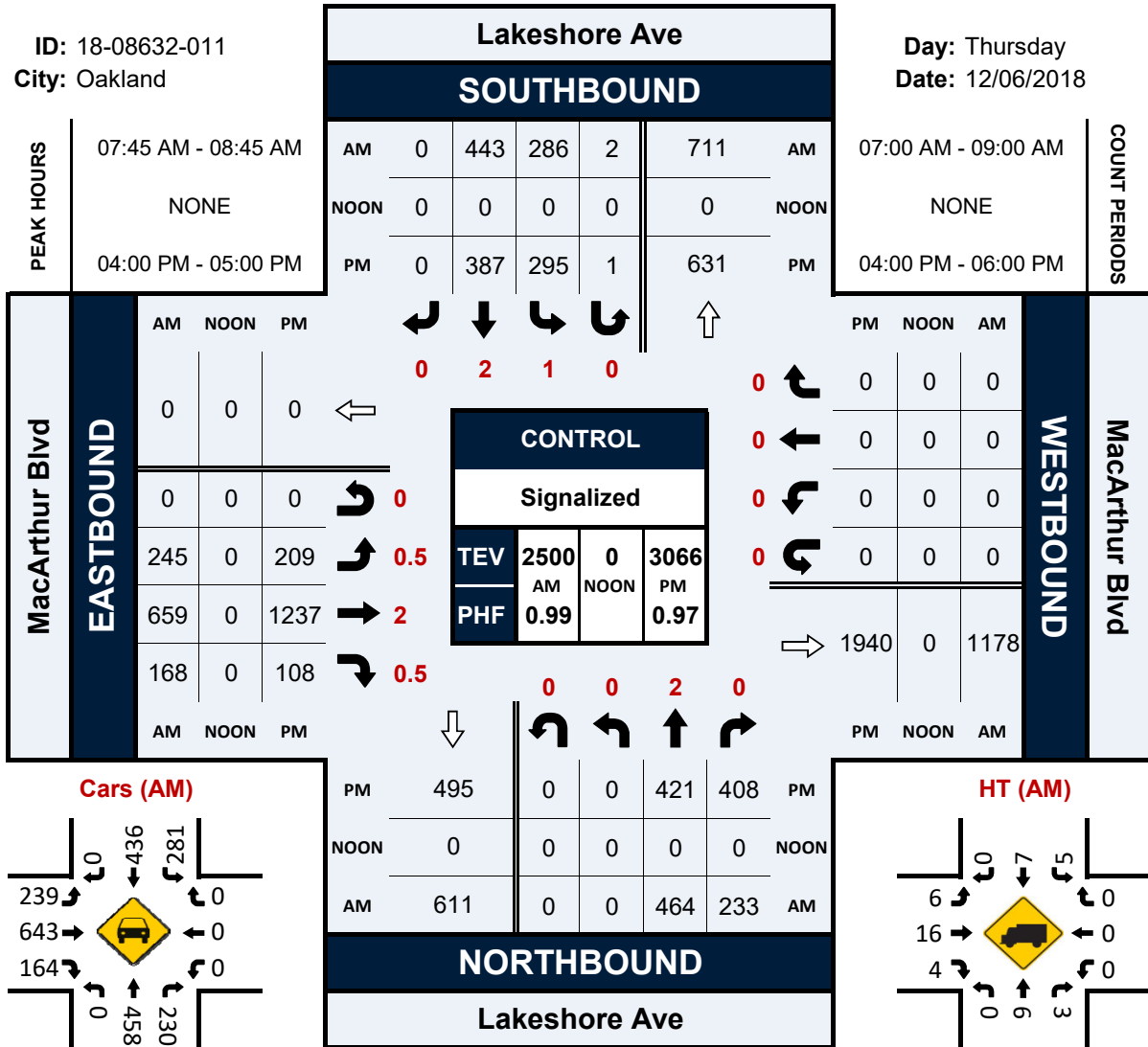


Lakeshore Ave & MacArthur Blvd

Peak Hour Turning Movement Count

ID: 18-08632-011
City: Oakland

Day: Thursday
Date: 12/06/2018



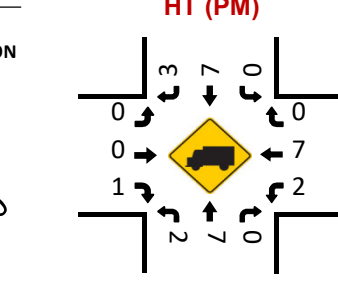
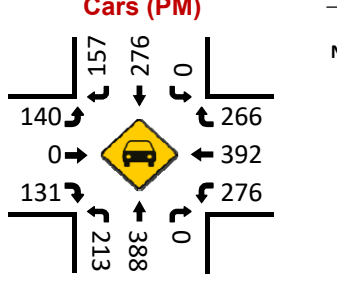
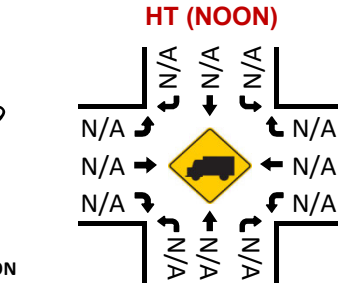
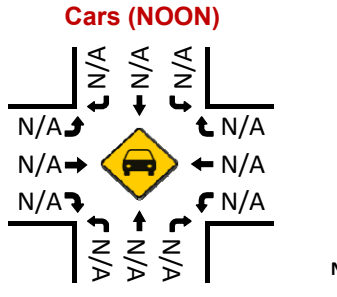
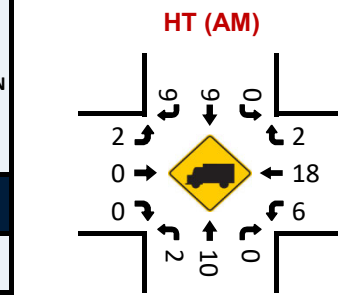
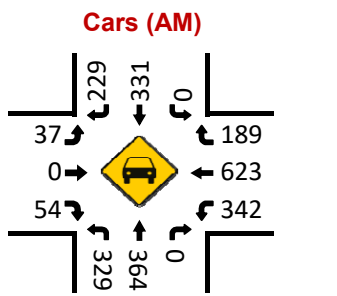
Lakeshore Ave & Lake Park Ave

Peak Hour Turning Movement Count

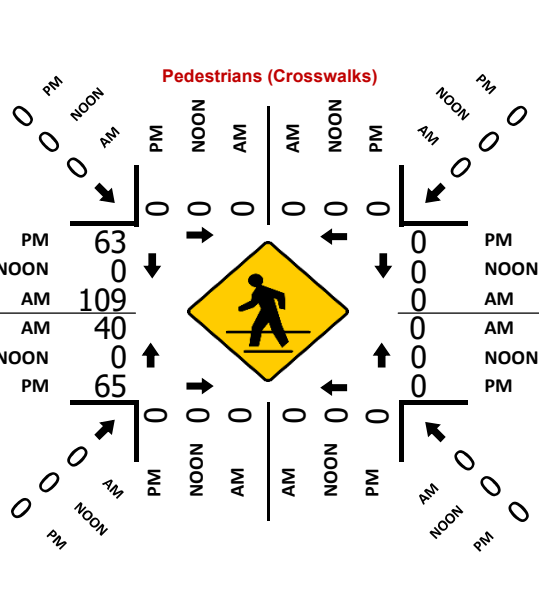
ID: 18-08632-012
City: Oakland

Day: Thursday
Date: 12/06/2018

PEAK HOURS		Lakeshore Ave SOUTHBOUND					COUNT PERIODS			
07:45 AM - 08:45 AM NONE 05:00 PM - 06:00 PM	AM	235	337	0	0	604	AM	07:00 AM - 09:00 AM NONE 04:00 PM - 06:00 PM		
	NOON	0	0	0	0	0	NOON			
	PM	160	283	0	0	801	PM			
Lakeshore Ave SOUTHBOUND	AM	NOON	PM	↓	0	2	0	0		
	←	1207	0	774	←	1	266	0	191	
	↪	0	0	0	↪	0	399	0	641	
	↪	39	0	140	↪	0	278	0	348	
	↪	0	0	0	↪	0	0	0	0	
CONTROL	Signalized		TEV		2551	0	2270	Lakeshore Ave NORTHBOUND		
			PHF		0.97		0.90	PM	NOON	AM
	AM	NOON	PM	↪	0	2	1	0		
	↪	54	0	132	↪	0	0	0		
Lakeshore Ave NORTHBOUND		AM	NOON	PM	↓	0	2	1	0	
AM	NOON	PM	↪	695	2	215	395	0		
↪	0	0	0	↪	0	0	0	0		
↪	740	1	331	374	0					
Lakeshore Ave NORTHBOUND		PM	NOON	AM	↪	0	0	0		
PM	NOON	AM	↪	0	0	0	0			
↪	0	0	↪	0	0	0	0			



PEAK HOURS		Lakeshore Ave NORTHBOUND				
07:45 AM - 08:45 AM NONE 05:00 PM - 06:00 PM	AM	740	1	331	374	0
	NOON	0	0	0	0	0
	PM	695	2	215	395	0

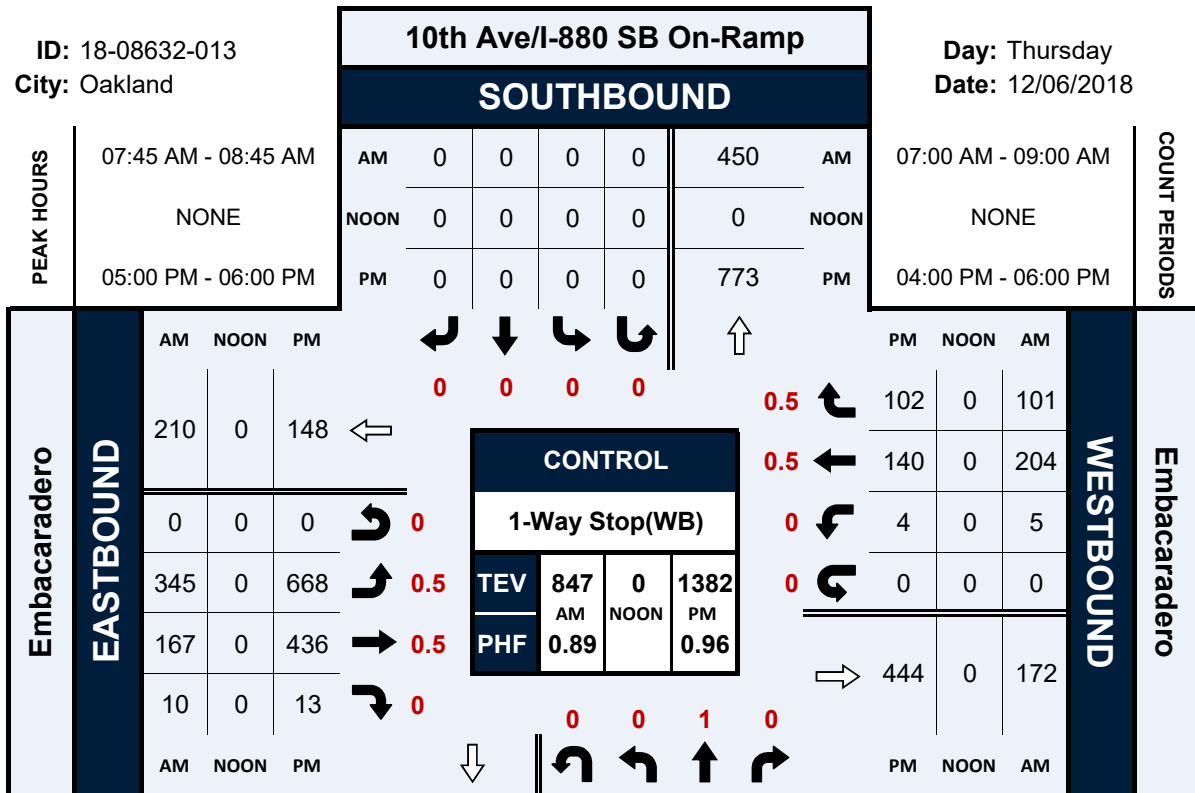


10th Ave/I-880 SB On-Ramp & Embacaradero

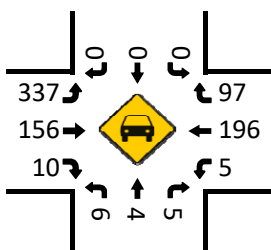
Peak Hour Turning Movement Count

ID: 18-08632-013
City: Oakland

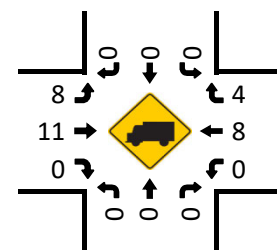
Day: Thursday
Date: 12/06/2018



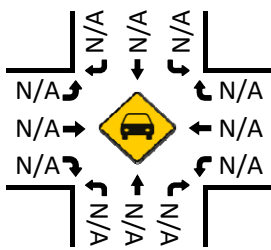
Cars (AM)



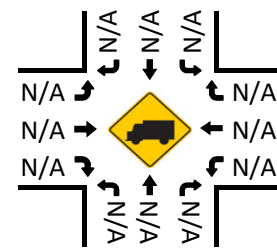
HT (AM)



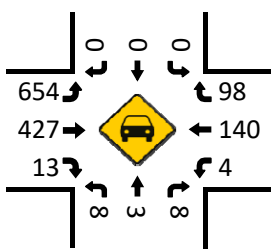
Cars (NOON)



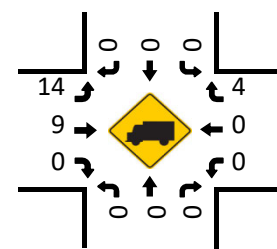
HT (NOON)



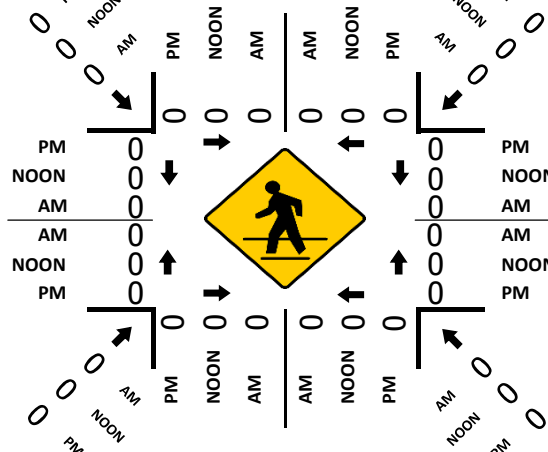
Cars (PM)



HT (PM)



Pedestrians (Crosswalks)

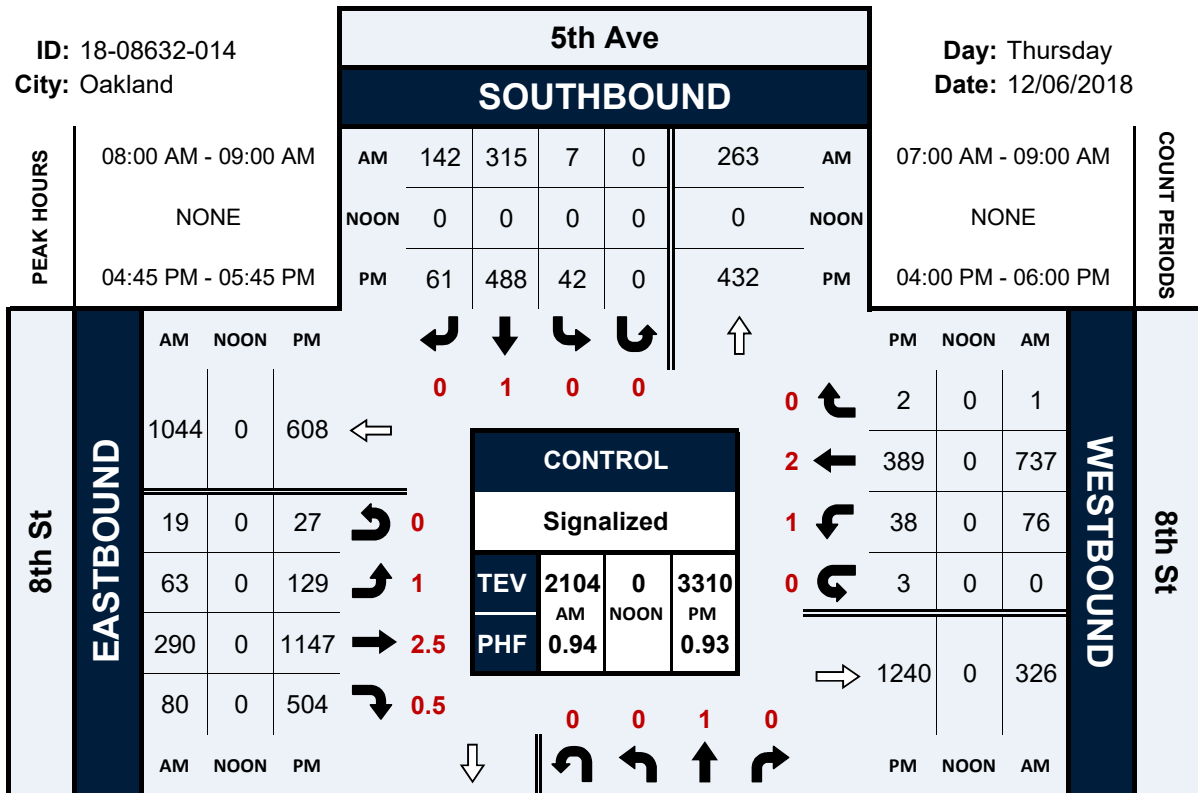


5th Ave & 8th St

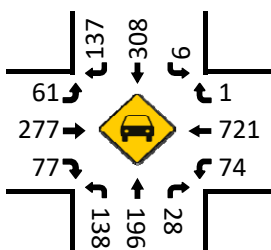
Peak Hour Turning Movement Count

ID: 18-08632-014
City: Oakland

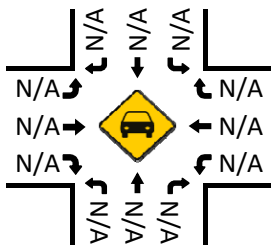
Day: Thursday
Date: 12/06/2018



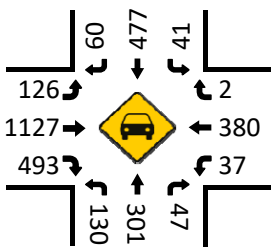
Cars (AM)



Cars (NOON)



Cars (PM)



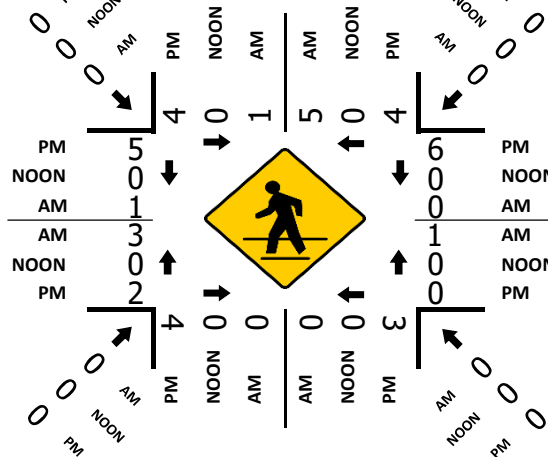
5th Ave NORTHBOUND



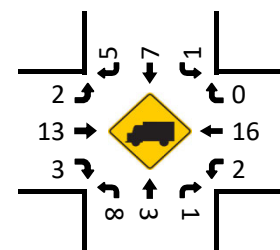
5th Ave SOUTHBOUND



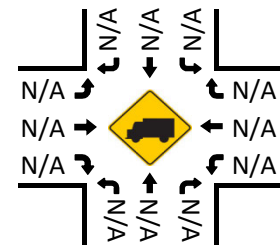
Pedestrians (Crosswalks)



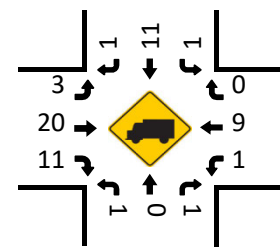
HT (AM)



HT (NOON)



HT (PM)

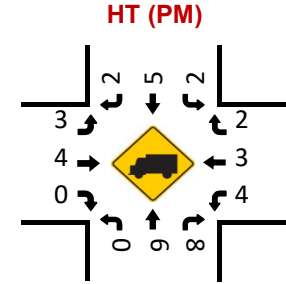
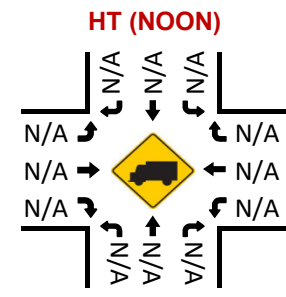
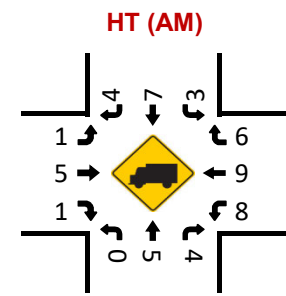
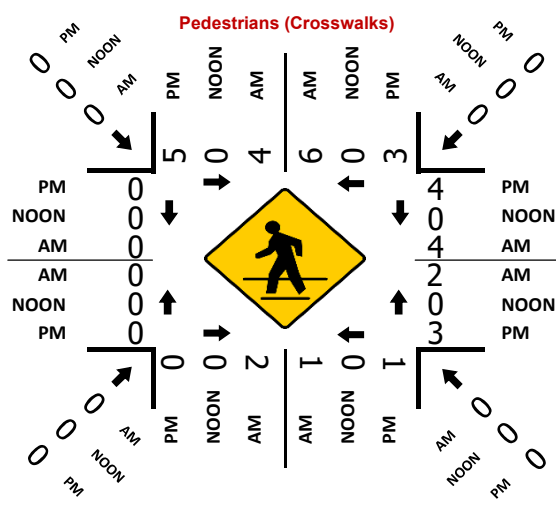
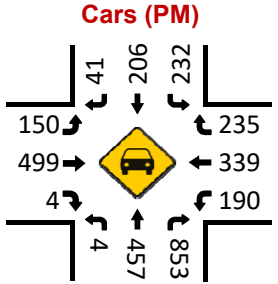
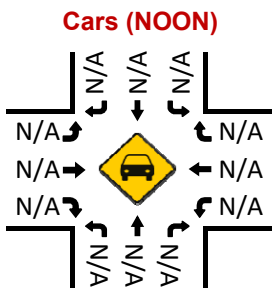
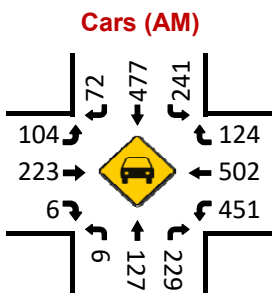
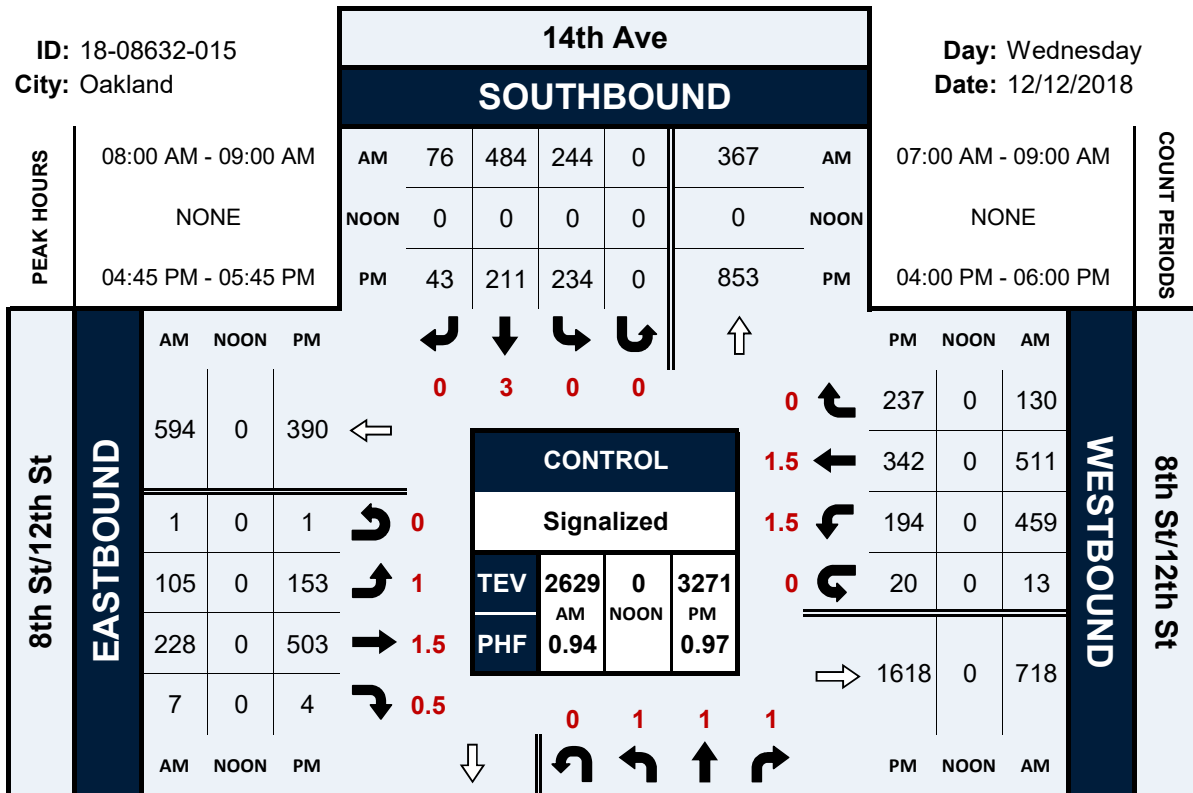


14th Ave & 8th St/12th St

Peak Hour Turning Movement Count

ID: 18-08632-015
City: Oakland

Day: Wednesday
Date: 12/12/2018

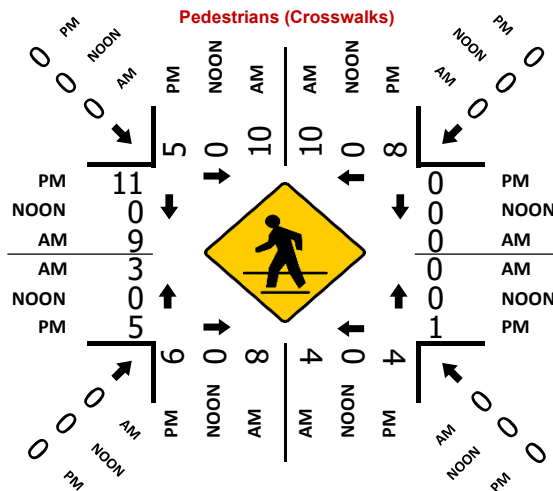
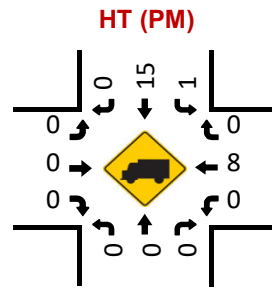
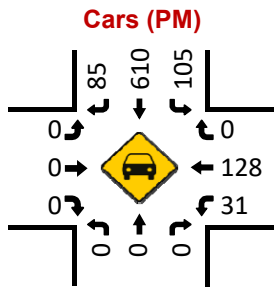
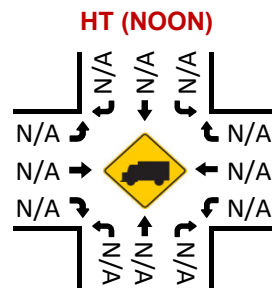
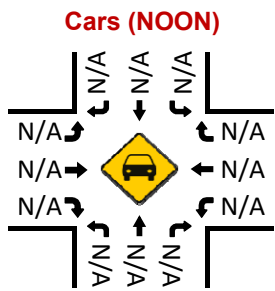
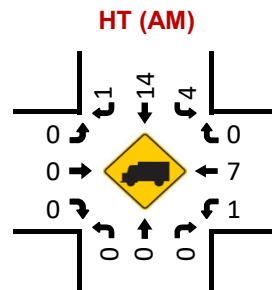
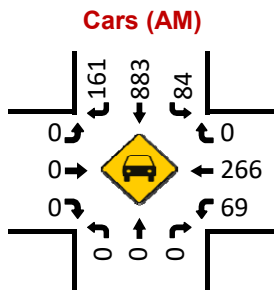
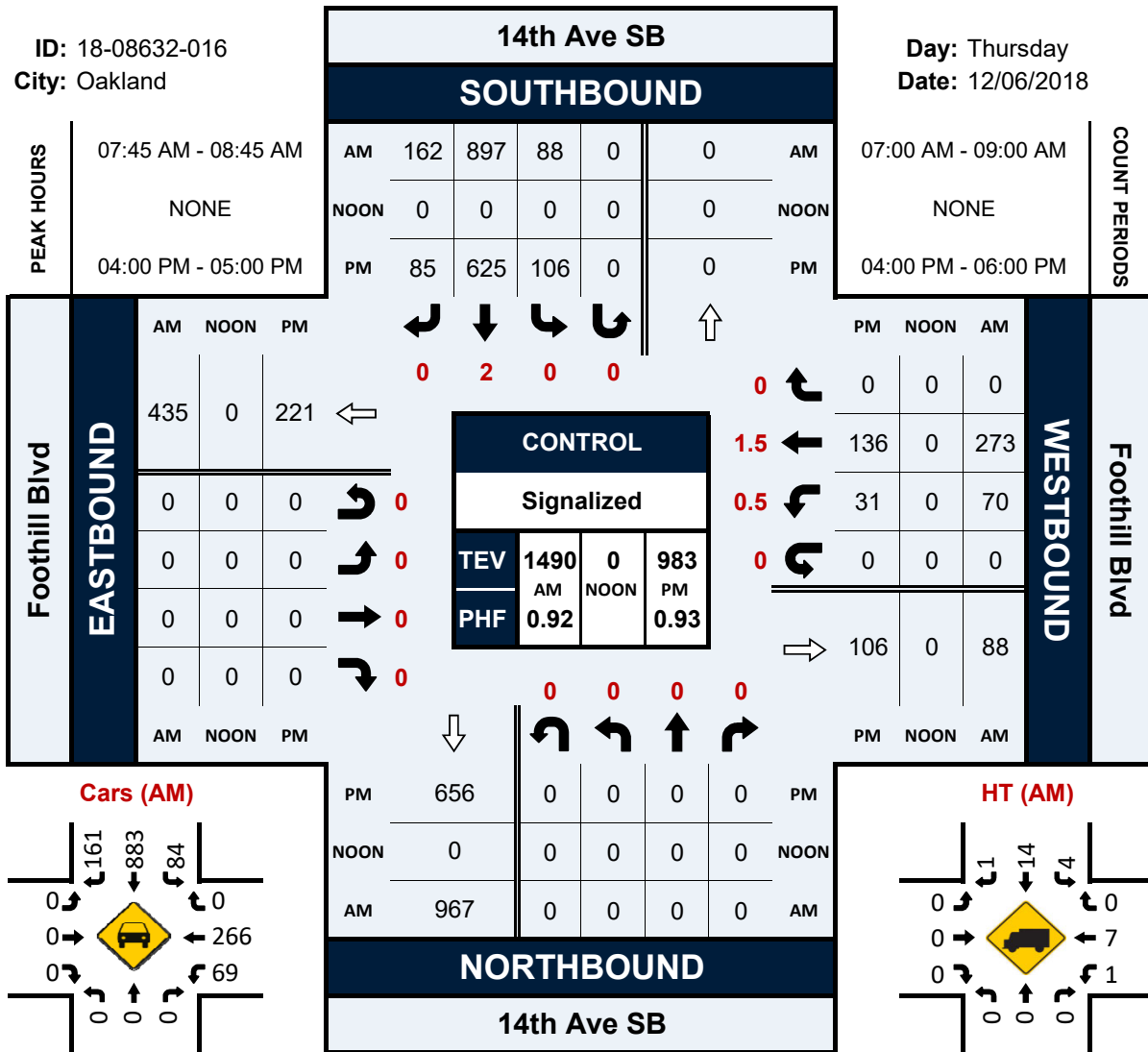


14th Ave SB & Foothill Blvd

Peak Hour Turning Movement Count

ID: 18-08632-016
City: Oakland

Day: Thursday
Date: 12/06/2018

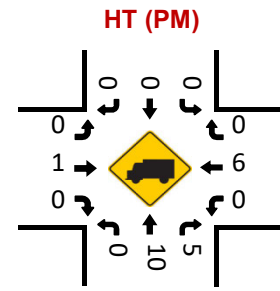
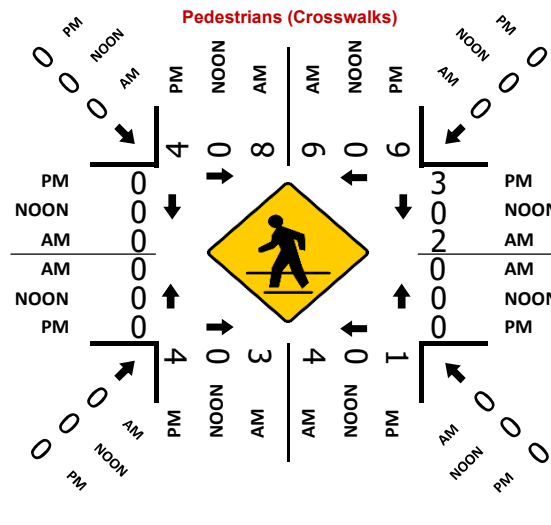
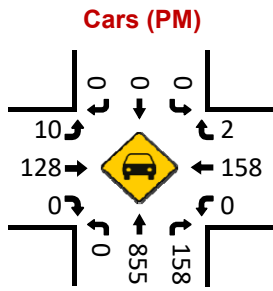
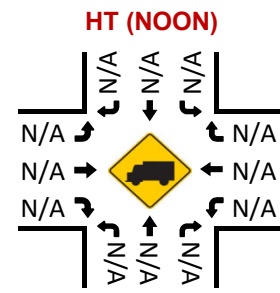
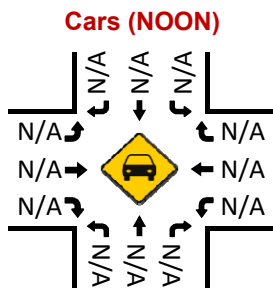
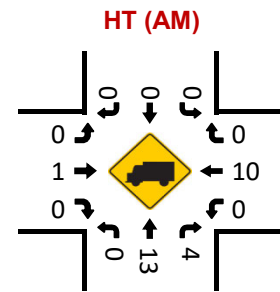
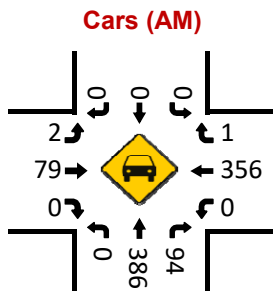
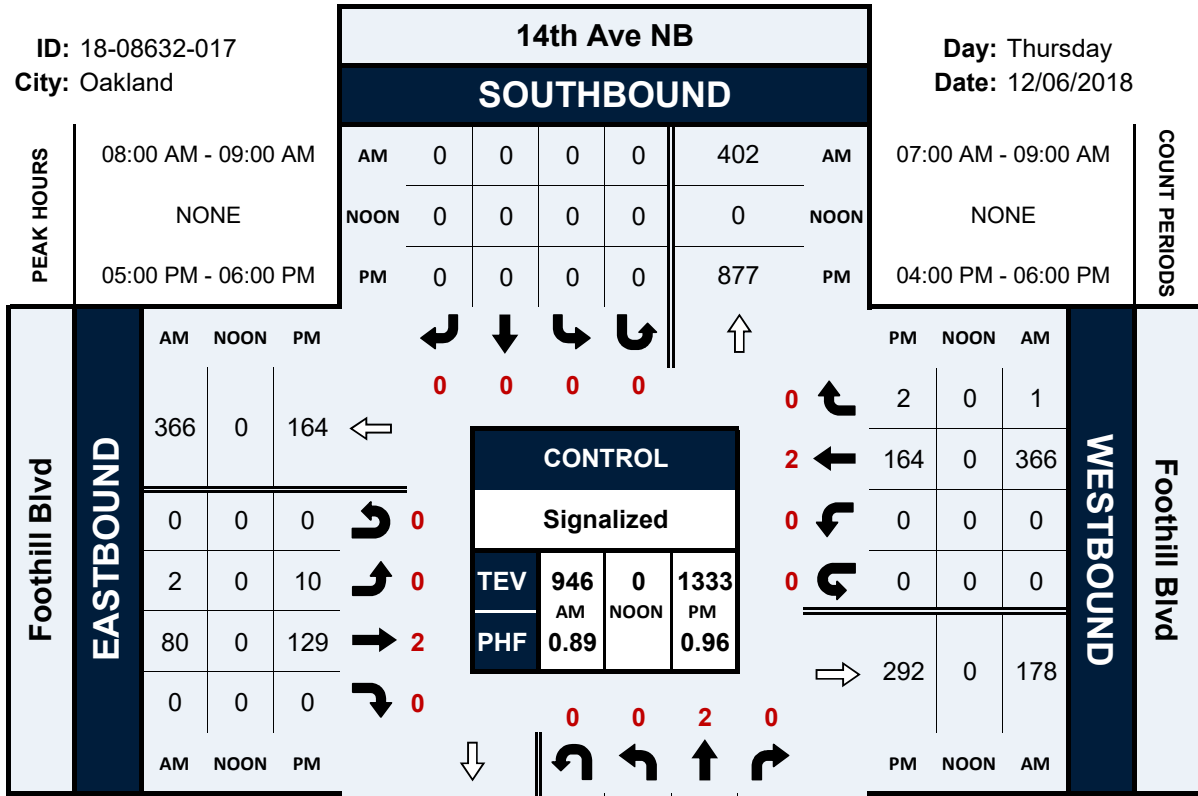


14th Ave NB & Foothill Blvd

Peak Hour Turning Movement Count

ID: 18-08632-017
City: Oakland

Day: Thursday
Date: 12/06/2018

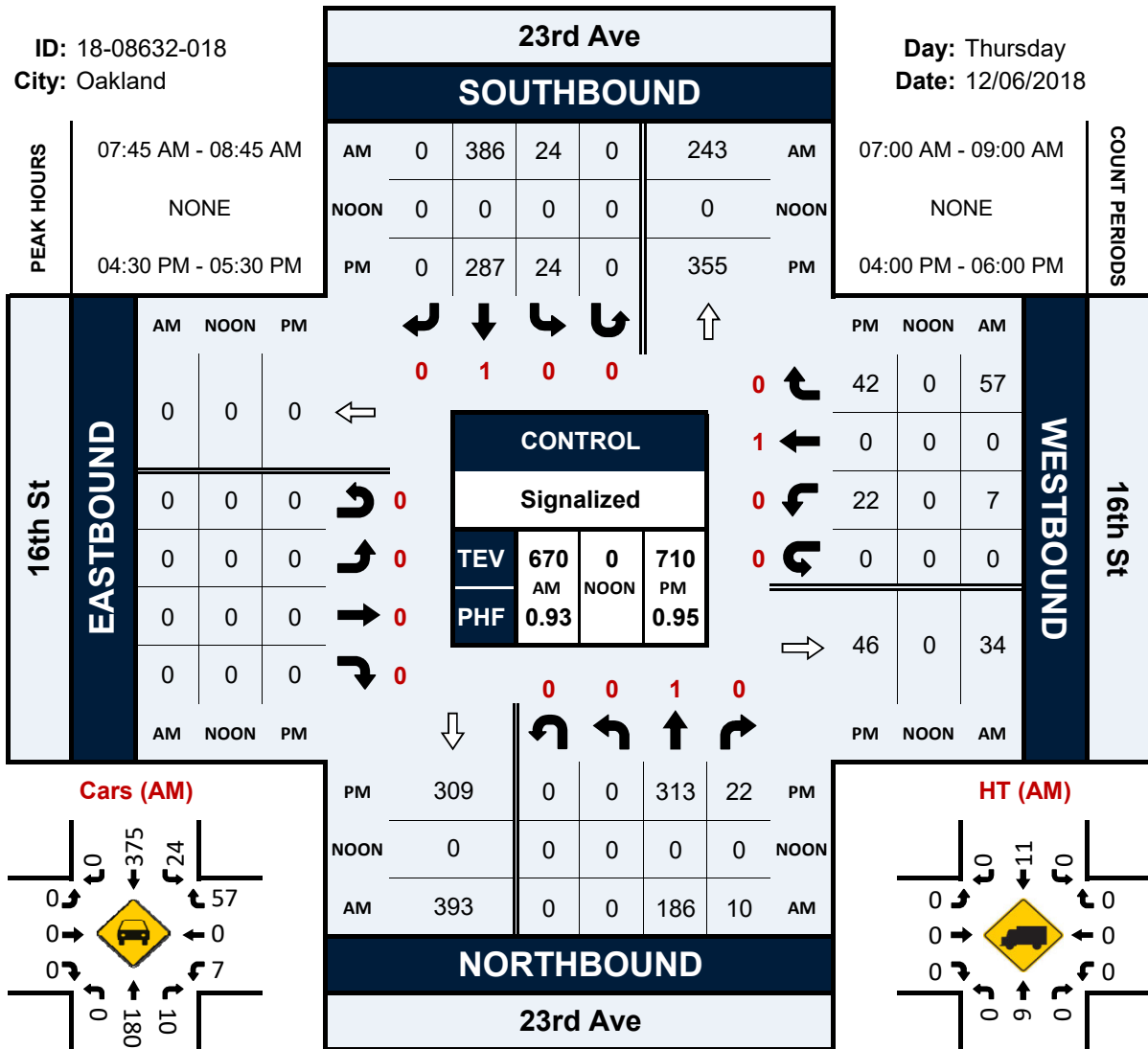


23rd Ave & 16th St

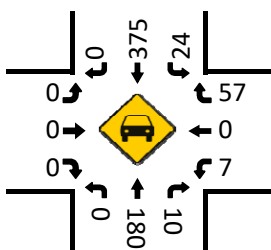
Peak Hour Turning Movement Count

ID: 18-08632-018
City: Oakland

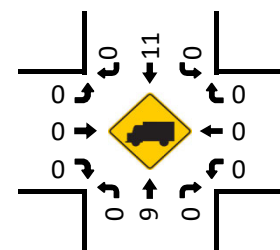
Day: Thursday
Date: 12/06/2018



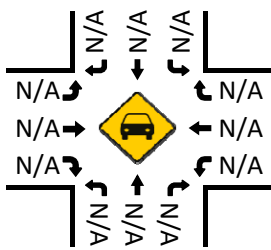
Cars (AM)



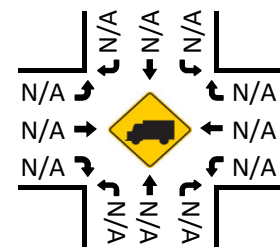
HT (AM)



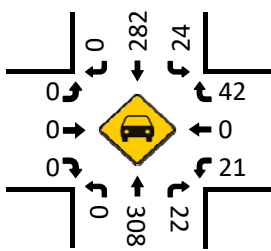
Cars (NOON)



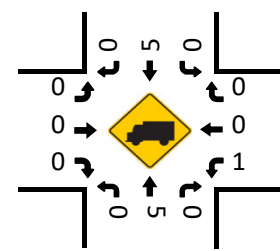
HT (NOON)



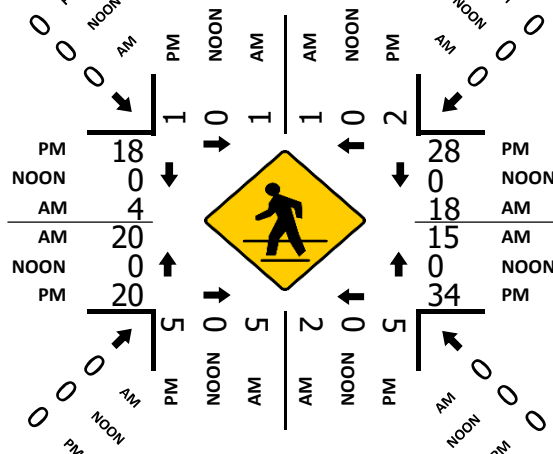
Cars (PM)



HT (PM)



Pedestrians (Crosswalks)



Attachment B

Intersection Analysis LOS Worksheets

Intersection						
Int Delay, s/veh	2.9					
Movement	EBL	EBR	NBL	NBT	SBT	SBR
Lane Configurations	↔		↔	↑	↑	
Traffic Vol, veh/h	79	24	53	394	154	21
Future Vol, veh/h	79	24	53	394	154	21
Conflicting Peds, #/hr	2	0	35	0	0	35
Sign Control	Stop	Stop	Free	Free	Free	Free
RT Channelized	-	None	-	None	-	None
Storage Length	0	-	0	-	-	-
Veh in Median Storage, #	0	-	-	0	0	-
Grade, %	0	-	-	0	0	-
Peak Hour Factor	100	100	100	100	100	100
Heavy Vehicles, %	8	8	8	8	8	8
Mvmt Flow	79	24	53	394	154	21

Major/Minor	Minor2	Major1		Major2	
Conflicting Flow All	702	200	210	0	0
Stage 1	200	-	-	-	-
Stage 2	502	-	-	-	-
Critical Hdwy	6.48	6.28	4.18	-	-
Critical Hdwy Stg 1	5.48	-	-	-	-
Critical Hdwy Stg 2	5.48	-	-	-	-
Follow-up Hdwy	3.572	3.372	2.272	-	-
Pot Cap-1 Maneuver	395	826	1326	-	-
Stage 1	820	-	-	-	-
Stage 2	596	-	-	-	-
Platoon blocked, %				-	-
Mov Cap-1 Maneuver	354	798	1282	-	-
Mov Cap-2 Maneuver	354	-	-	-	-
Stage 1	760	-	-	-	-
Stage 2	576	-	-	-	-

Approach	EB	NB	SB
HCM Control Delay, s	16.8	0.9	0
HCM LOS	C		

Minor Lane/Major Mvmt	NBL	NBT	EBLn1	SBT	SBR
Capacity (veh/h)	1282	-	407	-	-
HCM Lane V/C Ratio	0.041	-	0.253	-	-
HCM Control Delay (s)	7.9	-	16.8	-	-
HCM Lane LOS	A	-	C	-	-
HCM 95th %tile Q(veh)	0.1	-	1	-	-

2: Broadway & 5th Street HCM Signalized Intersection Capacity Analysis

03/14/2019



Movement	EBL	EBT	EBR	EBR2	NBT	NBR	NBR2	SBL2	SBL	SBT
Lane Configurations		↔↔	↗	↗	↑↑	↘			↘	↕↕
Traffic Volume (vph)	16	146	713	50	129	55	170	204	114	189
Future Volume (vph)	16	146	713	50	129	55	170	204	114	189
Ideal Flow (vphpl)	1900	1900	1900	1900	1900	1900	1900	1900	1900	1900
Total Lost time (s)		5.5	5.5	5.5	4.5	4.5			4.5	4.5
Lane Util. Factor		0.91	0.91	1.00	0.95	1.00			0.91	0.91
Frbp, ped/bikes		1.00	1.00	0.98	1.00	0.88			1.00	1.00
Flpb, ped/bikes		1.00	1.00	1.00	1.00	1.00			1.00	0.99
Frt		0.90	0.85	0.85	1.00	0.85			1.00	1.00
Flt Protected		1.00	1.00	1.00	1.00	1.00			0.95	0.98
Satd. Flow (prot)		2580	1225	1321	3008	1186			1369	2790
Flt Permitted		1.00	1.00	1.00	1.00	1.00			0.95	0.86
Satd. Flow (perm)		2580	1225	1321	3008	1186			1369	2432
Peak-hour factor, PHF	1.00	1.00	1.00	1.00	1.00	1.00	1.00	1.00	1.00	1.00
Adj. Flow (vph)	16	146	713	50	129	55	170	204	114	189
RTOR Reduction (vph)	0	0	0	35	0	147	0	0	0	0
Lane Group Flow (vph)	0	519	356	15	129	78	0	0	215	292
Confl. Peds. (#/hr)				5		55			55	
Confl. Bikes (#/hr)						1				
Heavy Vehicles (%)	8%	8%	8%	8%	8%	8%	8%	8%	8%	8%
Turn Type	Perm	NA	Prot	Perm	NA	Perm		Prot	Prot	NA
Protected Phases		4	4		2			1	1	6
Permitted Phases	4			4		2				
Actuated Green, G (s)		22.5	22.5	22.5	10.3	10.3			27.7	42.5
Effective Green, g (s)		22.5	22.5	22.5	10.3	10.3			27.7	42.5
Actuated g/C Ratio		0.30	0.30	0.30	0.14	0.14			0.37	0.57
Clearance Time (s)		5.5	5.5	5.5	4.5	4.5			4.5	4.5
Vehicle Extension (s)		2.0	2.0	2.0	2.0	2.0			2.0	2.0
Lane Grp Cap (vph)		774	367	396	413	162			505	1510
v/s Ratio Prot			c0.29		0.04				c0.16	0.07
v/s Ratio Perm		0.20		0.01		c0.07				0.04
v/c Ratio		0.93dr	0.97	0.04	0.31	0.48			0.43	0.19
Uniform Delay, d1		23.0	25.9	18.6	29.2	29.9			17.7	7.9
Progression Factor		1.00	1.00	1.00	1.00	1.00			1.00	1.00
Incremental Delay, d2		1.8	38.8	0.0	0.2	0.8			2.6	0.3
Delay (s)		24.8	64.7	18.6	29.3	30.7			20.3	8.2
Level of Service		C	E	B	C	C			C	A
Approach Delay (s)		39.8			30.2					13.3
Approach LOS		D			C					B

Intersection Summary

HCM 2000 Control Delay	30.4	HCM 2000 Level of Service	C
HCM 2000 Volume to Capacity ratio	0.64		
Actuated Cycle Length (s)	75.0	Sum of lost time (s)	14.5
Intersection Capacity Utilization	82.0%	ICU Level of Service	E
Analysis Period (min)	15		

dr Defacto Right Lane. Recode with 1 though lane as a right lane.

c Critical Lane Group

3: 6th Street & Jackson St
 HCM Signalized Intersection Capacity Analysis

03/14/2019



Movement	WBL	WBT	WBR2	NBL2	NBT	SBT	SBR	SER2
Lane Configurations	↖	↑	↗	↖	↑	↗		↗
Traffic Volume (vph)	15	301	110	171	390	131	399	1066
Future Volume (vph)	15	301	110	171	390	131	399	1066
Ideal Flow (vphpl)	1900	1900	1900	1900	1900	1900	1900	1900
Total Lost time (s)	5.5	5.5	5.5	5.5	5.5	5.5		5.5
Lane Util. Factor	1.00	1.00	1.00	1.00	1.00	1.00		1.00
Frpb, ped/bikes	1.00	1.00	0.98	1.00	1.00	0.98		1.00
Flpb, ped/bikes	0.99	1.00	1.00	1.00	1.00	1.00		1.00
Frt	1.00	1.00	0.85	1.00	1.00	0.90		0.86
Flt Protected	0.95	1.00	1.00	0.95	1.00	1.00		1.00
Satd. Flow (prot)	1566	1660	1383	1573	1660	1457		1450
Flt Permitted	0.95	1.00	1.00	0.38	1.00	1.00		1.00
Satd. Flow (perm)	1566	1660	1383	632	1660	1457		1450
Peak-hour factor, PHF	1.00	1.00	1.00	1.00	1.00	1.00	1.00	0.92
Adj. Flow (vph)	15	301	110	171	390	131	399	1159
RTOR Reduction (vph)	0	0	79	0	0	0	0	0
Lane Group Flow (vph)	15	301	31	171	390	530	0	1159
Confl. Peds. (#/hr)	3		5	6				6
Confl. Bikes (#/hr)			1					7
Heavy Vehicles (%)	3%	3%	3%	3%	3%	3%	3%	2%
Turn Type	Perm	NA	Perm	Perm	NA	NA		Perm
Protected Phases		8			2	6		
Permitted Phases	8		8	2				6 8
Actuated Green, G (s)	19.8	19.8	19.8	40.2	40.2	40.2		71.0
Effective Green, g (s)	19.8	19.8	19.8	40.2	40.2	40.2		71.0
Actuated g/C Ratio	0.28	0.28	0.28	0.57	0.57	0.57		1.00
Clearance Time (s)	5.5	5.5	5.5	5.5	5.5	5.5		
Vehicle Extension (s)	3.0	3.0	3.0	3.0	3.0	3.0		
Lane Grp Cap (vph)	436	462	385	357	939	824		1450
v/s Ratio Prot		0.18			0.23	0.36		
v/s Ratio Perm	0.01		0.02	0.27				c0.80
v/c Ratio	0.03	0.65	0.08	0.48	0.42	0.64		0.80
Uniform Delay, d1	18.6	22.6	18.9	9.2	8.7	10.5		0.0
Progression Factor	1.00	1.00	1.00	1.00	1.00	1.00		1.00
Incremental Delay, d2	0.0	3.3	0.1	4.5	1.4	3.8		3.2
Delay (s)	18.7	25.8	19.0	13.7	10.1	14.4		3.2
Level of Service	B	C	B	B	B	B		A
Approach Delay (s)		23.8			11.2	14.4		
Approach LOS		C			B	B		

Intersection Summary

HCM 2000 Control Delay	10.4	HCM 2000 Level of Service	B
HCM 2000 Volume to Capacity ratio	0.95		
Actuated Cycle Length (s)	71.0	Sum of lost time (s)	11.0
Intersection Capacity Utilization	155.2%	ICU Level of Service	H
Analysis Period (min)	15		
c Critical Lane Group			

Intersection												
Int Delay, s/veh	290.1											
Movement	EBL	EBT	EBR	WBL	WBT	WBR	NBL	NBT	NBR	SBL	SBT	SBR
Lane Configurations		↕	↕		↕			↕			↕	
Traffic Vol, veh/h	5	161	0	5	403	274	0	10	0	407	1	7
Future Vol, veh/h	5	161	0	5	403	274	0	10	0	407	1	7
Conflicting Peds, #/hr	0	0	5	5	0	0	4	0	0	0	0	4
Sign Control	Stop	Stop	Stop	Stop	Stop	Stop	Free	Free	Free	Free	Free	Free
RT Channelized	-	-	None	-	-	None	-	-	None	-	-	None
Storage Length	-	-	100	-	-	-	-	-	-	-	-	-
Veh in Median Storage, #	-	0	-	-	0	-	-	0	-	-	0	-
Grade, %	-	0	-	-	0	-	-	0	-	-	0	-
Peak Hour Factor	100	100	100	100	100	100	100	100	100	100	100	100
Heavy Vehicles, %	3	3	3	3	3	3	3	3	3	3	3	3
Mvmt Flow	5	161	0	5	403	274	0	10	0	407	1	7

Major/Minor	Minor2		Minor1		Major1		Major2					
Conflicting Flow All	1172	833	14	914	836	10	12	0	0	10	0	0
Stage 1	823	823	-	10	10	-	-	-	-	-	-	-
Stage 2	349	10	-	904	826	-	-	-	-	-	-	-
Critical Hdwy	7.13	6.53	6.23	7.13	6.53	6.23	4.13	-	-	4.13	-	-
Critical Hdwy Stg 1	6.13	5.53	-	6.13	5.53	-	-	-	-	-	-	-
Critical Hdwy Stg 2	6.13	5.53	-	6.13	5.53	-	-	-	-	-	-	-
Follow-up Hdwy	3.527	4.027	3.327	3.527	4.027	3.327	2.227	-	-	2.227	-	-
Pot Cap-1 Maneuver	168	303	1063	253	~ 302	1068	1600	-	-	1603	-	-
Stage 1	366	386	-	1008	885	-	-	-	-	-	-	-
Stage 2	665	885	-	330	~ 385	-	-	-	-	-	-	-
Platoon blocked, %								-	-	-	-	-
Mov Cap-1 Maneuver	-	225	1054	88	~ 224	1068	1594	-	-	1603	-	-
Mov Cap-2 Maneuver	-	225	-	88	~ 224	-	-	-	-	-	-	-
Stage 1	365	286	-	1008	885	-	-	-	-	-	-	-
Stage 2	269	885	-	107	~ 286	-	-	-	-	-	-	-

Approach	EB	WB	NB	SB
HCM Control Delay, s		\$ 536.6	0	7.9
HCM LOS	-	F		

Minor Lane/Major Mvmt	NBL	NBT	NBR	EBLn1	EBLn2	WBLn1	SBL	SBT	SBR
Capacity (veh/h)	1594	-	-	-	-	323	1603	-	-
HCM Lane V/C Ratio	-	-	-	-	-	2.111	0.254	-	-
HCM Control Delay (s)	0	-	-	-	0	\$ 536.6	8	0	-
HCM Lane LOS	A	-	-	-	A	F	A	A	-
HCM 95th %tile Q(veh)	0	-	-	-	-	50	1	-	-

Notes
 ~: Volume exceeds capacity \$: Delay exceeds 300s +: Computation Not Defined *: All major volume in platoon

5: Embarcadero W & 880 Off-Ramp
 HCM 2010 TWSC

03/14/2019

Intersection												
Int Delay, s/veh	4.3											
Movement	EBL	EBT	EBR	WBL	WBT	WBR	NBL	NBT	NBR	SBL	SBT	SBR
Lane Configurations		↑			↑						↑	↑
Traffic Vol, veh/h	0	568	0	0	414	0	0	0	0	75	0	268
Future Vol, veh/h	0	568	0	0	414	0	0	0	0	75	0	268
Conflicting Peds, #/hr	0	0	0	0	0	0	0	0	0	0	0	0
Sign Control	Free	Free	Free	Free	Free	Free	Stop	Stop	Stop	Stop	Stop	Stop
RT Channelized	-	-	None	-	-	None	-	-	None	-	-	None
Storage Length	-	-	-	-	-	-	-	-	-	-	-	0
Veh in Median Storage, #	-	0	-	-	0	-	-	-	-	-	0	-
Grade, %	-	0	-	-	0	-	-	0	-	-	0	-
Peak Hour Factor	100	100	100	100	100	100	100	100	100	100	100	100
Heavy Vehicles, %	4	4	2	2	4	4	2	2	2	4	2	4
Mvmt Flow	0	568	0	0	414	0	0	0	0	75	0	268























Major/Minor	Major1			Major2			Minor2				
Conflicting Flow All	-	0	-	-	-	0	-	-	982	982	414
Stage 1	-	-	-	-	-	-	-	-	414	414	-
Stage 2	-	-	-	-	-	-	-	-	568	568	-
Critical Hdwy	-	-	-	-	-	-	-	-	6.44	6.52	6.24
Critical Hdwy Stg 1	-	-	-	-	-	-	-	-	5.44	5.52	-
Critical Hdwy Stg 2	-	-	-	-	-	-	-	-	5.44	5.52	-
Follow-up Hdwy	-	-	-	-	-	-	-	-	3.536	4.018	3.336
Pot Cap-1 Maneuver	0	-	0	0	-	0	-	-	274	249	634
Stage 1	0	-	0	0	-	0	-	-	663	593	-
Stage 2	0	-	0	0	-	0	-	-	563	506	-
Platoon blocked, %	-	-	-	-	-	-	-	-	-	-	-
Mov Cap-1 Maneuver	-	-	-	-	-	-	-	-	274	0	634
Mov Cap-2 Maneuver	-	-	-	-	-	-	-	-	274	0	-
Stage 1	-	-	-	-	-	-	-	-	663	0	-
Stage 2	-	-	-	-	-	-	-	-	563	0	-

Approach	EB	WB	SB
HCM Control Delay, s	0	0	16.6
HCM LOS			C

Minor Lane/Major Mvmt	EBT	WBT	SBLn1	SBLn2
Capacity (veh/h)	-	-	274	634
HCM Lane V/C Ratio	-	-	0.274	0.423
HCM Control Delay (s)	-	-	23	14.8
HCM Lane LOS	-	-	C	B
HCM 95th %tile Q(veh)	-	-	1.1	2.1

6: Webster St & Atlantic Ave
 HCM 2010 Signalized Intersection Summary

03/14/2019

												
Movement	EBL	EBT	EBR	WBL	WBT	WBR	NBL	NBT	NBR	SBL	SBT	SBR
Lane Configurations												
Traffic Volume (veh/h)	172	300	146	23	374	46	140	537	66	84	364	315
Future Volume (veh/h)	172	300	146	23	374	46	140	537	66	84	364	315
Number	7	4	14	3	8	18	5	2	12	1	6	16
Initial Q (Qb), veh	0	0	0	0	0	0	0	0	0	0	0	0
Ped-Bike Adj(A_pbT)	1.00		0.96	1.00		0.92	1.00		0.96	1.00		0.94
Parking Bus, Adj	1.00	1.00	1.00	1.00	1.00	1.00	1.00	1.00	1.00	1.00	1.00	1.00
Adj Sat Flow, veh/h/ln	1827	1827	1827	1827	1827	1900	1827	1827	1900	1827	1827	1827
Adj Flow Rate, veh/h	187	326	19	25	407	50	152	584	72	91	396	57
Adj No. of Lanes	2	2	1	1	2	0	1	2	0	1	2	1
Peak Hour Factor	0.92	0.92	0.92	0.92	0.92	0.92	0.92	0.92	0.92	0.92	0.92	0.92
Percent Heavy Veh, %	4	4	4	4	4	4	4	4	4	4	4	4
Cap, veh/h	637	655	281	417	739	90	191	885	109	116	843	356
Arrive On Green	0.19	0.19	0.19	0.24	0.24	0.24	0.11	0.29	0.29	0.07	0.24	0.24
Sat Flow, veh/h	3375	3471	1489	1740	3081	375	1740	3094	380	1740	3471	1467
Grp Volume(v), veh/h	187	326	19	25	228	229	152	327	329	91	396	57
Grp Sat Flow(s),veh/h/ln	1688	1736	1489	1740	1736	1720	1740	1736	1739	1740	1736	1467
Q Serve(g_s), s	3.7	6.5	0.8	0.9	8.9	9.1	6.6	12.9	12.9	4.0	7.6	2.4
Cycle Q Clear(g_c), s	3.7	6.5	0.8	0.9	8.9	9.1	6.6	12.9	12.9	4.0	7.6	2.4
Prop In Lane	1.00		1.00	1.00		0.22	1.00		0.22	1.00		1.00
Lane Grp Cap(c), veh/h	637	655	281	417	416	413	191	496	497	116	843	356
V/C Ratio(X)	0.29	0.50	0.07	0.06	0.55	0.56	0.80	0.66	0.66	0.79	0.47	0.16
Avail Cap(c_a), veh/h	1086	1117	479	560	559	554	381	871	873	157	1296	548
HCM Platoon Ratio	1.00	1.00	1.00	1.00	1.00	1.00	1.00	1.00	1.00	1.00	1.00	1.00
Upstream Filter(I)	1.00	1.00	1.00	1.00	1.00	1.00	1.00	1.00	1.00	1.00	1.00	1.00
Uniform Delay (d), s/veh	27.1	28.2	25.9	22.8	25.8	25.9	33.7	24.4	24.4	35.7	25.1	23.2
Incr Delay (d2), s/veh	0.3	0.6	0.1	0.1	1.1	1.2	7.4	1.5	1.5	16.6	0.4	0.2
Initial Q Delay(d3),s/veh	0.0	0.0	0.0	0.0	0.0	0.0	0.0	0.0	0.0	0.0	0.0	0.0
%ile BackOfQ(50%),veh/ln	1.7	3.2	0.3	0.4	4.4	4.5	3.6	6.4	6.4	2.5	3.7	1.0
LnGrp Delay(d),s/veh	27.3	28.8	26.0	22.8	26.9	27.1	41.1	25.9	25.9	52.3	25.5	23.4
LnGrp LOS	C	C	C	C	C	C	D	C	C	D	C	C
Approach Vol, veh/h		532			482			808			544	
Approach Delay, s/veh		28.2			26.8			28.8			29.8	
Approach LOS		C			C			C			C	
Timer	1	2	3	4	5	6	7	8				
Assigned Phs	1	2		4	5	6		8				
Phs Duration (G+Y+Rc), s	9.2	27.2		18.7	12.5	23.9		22.6				
Change Period (Y+Rc), s	4.0	5.0		4.0	4.0	5.0		4.0				
Max Green Setting (Gmax), s	7.0	39.0		25.0	17.0	29.0		25.0				
Max Q Clear Time (g_c+I1), s	6.0	14.9		8.5	8.6	9.6		11.1				
Green Ext Time (p_c), s	0.0	4.5		2.7	0.2	2.8		2.5				
Intersection Summary												
HCM 2010 Ctrl Delay			28.5									
HCM 2010 LOS			C									

Intersection

Intersection Delay, s/veh 7.9

Intersection LOS A

















Movement	EBL	EBT	EBR	WBL	WBT	WBR	NBL	NBT	NBR	SBL	SBT	SBR
Lane Configurations		↕			↕			↕			↕	
Traffic Vol, veh/h	9	29	6	5	71	60	2	9	3	32	19	7
Future Vol, veh/h	9	29	6	5	71	60	2	9	3	32	19	7
Peak Hour Factor	1.00	1.00	1.00	1.00	1.00	1.00	1.00	1.00	1.00	1.00	1.00	1.00
Heavy Vehicles, %	15	15	15	15	15	15	15	15	15	15	15	15
Mvmt Flow	9	29	6	5	71	60	2	9	3	32	19	7
Number of Lanes	0	1	0	0	1	0	0	1	0	0	2	0

Approach	EB	WB	NB	SB
Opposing Approach	WB	EB	SB	NB
Opposing Lanes	1	1	2	1
Conflicting Approach Left	SB	NB	EB	WB
Conflicting Lanes Left	2	1	1	1
Conflicting Approach Right	NB	SB	WB	EB
Conflicting Lanes Right	1	2	1	1
HCM Control Delay	7.7	7.9	7.7	8.3
HCM LOS	A	A	A	A

Lane	NBLn1	EBLn1	WBLn1	SBLn1	SBLn2
Vol Left, %	14%	20%	4%	77%	0%
Vol Thru, %	64%	66%	52%	23%	58%
Vol Right, %	21%	14%	44%	0%	42%
Sign Control	Stop	Stop	Stop	Stop	Stop
Traffic Vol by Lane	14	44	136	42	17
LT Vol	2	9	5	32	0
Through Vol	9	29	71	10	10
RT Vol	3	6	60	0	7
Lane Flow Rate	14	44	136	42	16
Geometry Grp	5	2	2	7	7
Degree of Util (X)	0.018	0.054	0.153	0.063	0.022
Departure Headway (Hd)	4.634	4.445	4.054	5.462	4.778
Convergence, Y/N	Yes	Yes	Yes	Yes	Yes
Cap	777	810	872	649	739
Service Time	2.636	2.445	2.141	3.257	2.572
HCM Lane V/C Ratio	0.018	0.054	0.156	0.065	0.022
HCM Control Delay	7.7	7.7	7.9	8.6	7.7
HCM Lane LOS	A	A	A	A	A
HCM 95th-tile Q	0.1	0.2	0.5	0.2	0.1






















8: Oak St & 5th Street
 HCM 2010 Signalized Intersection Summary

03/14/2019

												
Movement	EBL	EBT	EBR	WBL	WBT	WBR	NBL	NBT	NBR	SBL	SBT	SBR
Lane Configurations												
Traffic Volume (veh/h)	291	485	132	0	0	0	0	129	61	2	47	0
Future Volume (veh/h)	291	485	132	0	0	0	0	129	61	2	47	0
Number	7	4	14				5	2	12	1	6	16
Initial Q (Qb), veh	0	0	0				0	0	0	0	0	0
Ped-Bike Adj(A_pbT)	1.00		0.99				1.00		0.97	0.99		1.00
Parking Bus, Adj	1.00	1.00	1.00				1.00	1.00	1.00	1.00	1.00	1.00
Adj Sat Flow, veh/h/ln	1629	1629	1710				0	1629	1710	1710	1629	0
Adj Flow Rate, veh/h	291	485	132				0	129	61	2	47	0
Adj No. of Lanes	1	2	0				0	1	0	0	1	0
Peak Hour Factor	1.00	1.00	1.00				1.00	1.00	1.00	1.00	1.00	1.00
Percent Heavy Veh, %	5	5	5				0	5	5	5	5	0
Cap, veh/h	404	625	169				0	632	299	67	973	0
Arrive On Green	0.26	0.26	0.26				0.00	0.61	0.61	0.61	0.61	0.00
Sat Flow, veh/h	1551	2403	650				0	1034	489	23	1592	0
Grp Volume(v), veh/h	291	311	306				0	0	190	49	0	0
Grp Sat Flow(s),veh/h/ln	1551	1547	1505				0	0	1523	1615	0	0
Q Serve(g_s), s	12.0	13.0	13.2				0.0	0.0	3.9	0.0	0.0	0.0
Cycle Q Clear(g_c), s	12.0	13.0	13.2				0.0	0.0	3.9	0.8	0.0	0.0
Prop In Lane	1.00		0.43				0.00		0.32	0.04		0.00
Lane Grp Cap(c), veh/h	404	402	392				0	0	931	1041	0	0
V/C Ratio(X)	0.72	0.77	0.78				0.00	0.00	0.20	0.05	0.00	0.00
Avail Cap(c_a), veh/h	809	807	785				0	0	931	1041	0	0
HCM Platoon Ratio	1.00	1.00	1.00				1.00	1.00	1.00	1.00	1.00	1.00
Upstream Filter(I)	1.00	1.00	1.00				0.00	0.00	1.00	1.00	0.00	0.00
Uniform Delay (d), s/veh	23.6	24.0	24.0				0.0	0.0	6.0	5.5	0.0	0.0
Incr Delay (d2), s/veh	0.9	1.2	1.3				0.0	0.0	0.5	0.1	0.0	0.0
Initial Q Delay(d3),s/veh	0.0	0.0	0.0				0.0	0.0	0.0	0.0	0.0	0.0
%ile BackOfQ(50%),veh/ln	5.2	5.7	5.6				0.0	0.0	1.8	0.4	0.0	0.0
LnGrp Delay(d),s/veh	24.5	25.2	25.3				0.0	0.0	6.5	5.5	0.0	0.0
LnGrp LOS	C	C	C						A	A		
Approach Vol, veh/h		908						190			49	
Approach Delay, s/veh		25.0						6.5			5.5	
Approach LOS		C						A			A	
Timer	1	2	3	4	5	6	7	8				
Assigned Phs		2		4		6						
Phs Duration (G+Y+Rc), s		47.3		22.7		47.3						
Change Period (Y+Rc), s		4.5		4.5		4.5						
Max Green Setting (Gmax), s		24.5		36.5		24.5						
Max Q Clear Time (g_c+I1), s		5.9		15.2		2.8						
Green Ext Time (p_c), s		0.6		2.9		0.1						
Intersection Summary												
HCM 2010 Ctrl Delay			21.1									
HCM 2010 LOS			C									













9: Harrison St & Grand Ave
 HCM 2010 Signalized Intersection Summary

03/14/2019

												
Movement	EBL	EBT	EBR	WBL	WBT	WBR	NBL	NBT	NBR	SBL	SBT	SBR
Lane Configurations												
Traffic Volume (veh/h)	74	213	51	274	568	120	52	440	261	13	462	149
Future Volume (veh/h)	74	213	51	274	568	120	52	440	261	13	462	149
Number	3	8	18	7	4	14	5	2	12	1	6	16
Initial Q (Qb), veh	0	0	0	0	0	0	0	0	0	0	0	0
Ped-Bike Adj(A_pbT)	1.00		0.74	1.00		0.81	0.90		1.00	0.89		0.74
Parking Bus, Adj	1.00	1.00	1.00	1.00	1.00	1.00	1.00	1.00	1.00	1.00	1.00	1.00
Adj Sat Flow, veh/h/ln	1845	1845	1845	1845	1845	1900	1900	1845	1845	1900	1845	1845
Adj Flow Rate, veh/h	74	213	22	274	568	120	52	440	0	13	462	33
Adj No. of Lanes	2	2	1	2	2	0	0	3	1	0	2	1
Peak Hour Factor	1.00	1.00	1.00	1.00	1.00	1.00	1.00	1.00	1.00	1.00	1.00	1.00
Percent Heavy Veh, %	3	3	3	3	3	3	3	3	3	3	3	3
Cap, veh/h	160	1145	381	615	1320	277	145	1156	480	53	1029	355
Arrive On Green	0.05	0.33	0.33	0.18	0.48	0.48	0.31	0.31	0.00	0.31	0.31	0.31
Sat Flow, veh/h	3408	3505	1165	3408	2761	579	293	3776	1568	36	3361	1159
Grp Volume(v), veh/h	74	213	22	274	359	329	140	352	0	253	222	33
Grp Sat Flow(s),veh/h/ln	1704	1752	1165	1704	1752	1587	1014	1528	1568	1802	1595	1159
Q Serve(g_s), s	1.9	3.9	1.2	6.4	12.1	12.3	3.5	8.1	0.0	0.0	10.1	1.8
Cycle Q Clear(g_c), s	1.9	3.9	1.2	6.4	12.1	12.3	13.6	8.1	0.0	9.9	10.1	1.8
Prop In Lane	1.00		1.00	1.00		0.36	0.37		1.00	0.05		1.00
Lane Grp Cap(c), veh/h	160	1145	381	615	838	759	365	936	480	594	488	355
V/C Ratio(X)	0.46	0.19	0.06	0.45	0.43	0.43	0.38	0.38	0.00	0.43	0.45	0.09
Avail Cap(c_a), veh/h	417	1145	381	615	838	759	391	998	512	629	521	379
HCM Platoon Ratio	1.00	1.00	1.00	1.00	1.00	1.00	1.00	1.00	1.00	1.00	1.00	1.00
Upstream Filter(I)	1.00	1.00	1.00	1.00	1.00	1.00	1.00	1.00	0.00	1.00	1.00	1.00
Uniform Delay (d), s/veh	41.8	21.7	20.8	32.9	15.4	15.5	25.6	24.5	0.0	25.1	25.2	22.3
Incr Delay (d2), s/veh	2.1	0.4	0.3	0.5	1.6	1.8	0.7	0.3	0.0	0.5	0.7	0.1
Initial Q Delay(d3),s/veh	0.0	0.0	0.0	0.0	0.0	0.0	0.0	0.0	0.0	0.0	0.0	0.0
%ile BackOfQ(50%),veh/ln	0.9	2.0	0.4	3.1	6.2	5.8	3.0	3.5	0.0	5.1	4.5	0.6
LnGrp Delay(d),s/veh	43.9	22.1	21.1	33.4	17.0	17.3	26.3	24.7	0.0	25.6	25.8	22.4
LnGrp LOS	D	C	C	C	B	B	C	C		C	C	C
Approach Vol, veh/h		309			962			492			508	
Approach Delay, s/veh		27.2			21.8			25.2			25.5	
Approach LOS		C			C			C			C	
Timer	1	2	3	4	5	6	7	8				
Assigned Phs		2	3	4		6	7	8				
Phs Duration (G+Y+Rc), s		33.2	8.2	48.6		33.2	21.8	35.0				
Change Period (Y+Rc), s		5.6	4.0	5.6		5.6	5.6	* 5.6				
Max Green Setting (Gmax), s		29.4	11.0	34.4		29.4	16.0	* 29				
Max Q Clear Time (g_c+I1), s		15.6	3.9	14.3		12.1	8.4	5.9				
Green Ext Time (p_c), s		2.8	0.1	4.5		2.8	0.6	1.4				
Intersection Summary												
HCM 2010 Ctrl Delay			24.1									
HCM 2010 LOS			C									
Notes												



















10: Lakeshore Ave & Foothill Blvd
 HCM 2010 Signalized Intersection Summary

03/14/2019

								
Movement	WBL	WBR	NBT	NBR	SBL	SBT		
Lane Configurations	 		 			 		
Traffic Volume (veh/h)	194	134	476	0	0	991		
Future Volume (veh/h)	194	134	476	0	0	991		
Number	3	18	2	12	1	6		
Initial Q (Qb), veh	0	0	0	0	0	0		
Ped-Bike Adj(A_pbT)	1.00	1.00		1.00	1.00			
Parking Bus, Adj	1.00	1.00	1.00	1.00	1.00	1.00		
Adj Sat Flow, veh/h/ln	1863	1900	1863	0	0	1863		
Adj Flow Rate, veh/h	164	166	476	0	0	991		
Adj No. of Lanes	1	1	2	0	0	2		
Peak Hour Factor	1.00	1.00	1.00	1.00	1.00	1.00		
Percent Heavy Veh, %	2	0	2	0	0	2		
Cap, veh/h	218	198	2815	0	0	2815		
Arrive On Green	0.12	0.12	0.80	0.00	0.00	0.80		
Sat Flow, veh/h	1774	1615	3725	0	0	3725		
Grp Volume(v), veh/h	164	166	476	0	0	991		
Grp Sat Flow(s),veh/h/ln	1774	1615	1770	0	0	1770		
Q Serve(g_s), s	9.8	11.1	3.5	0.0	0.0	8.8		
Cycle Q Clear(g_c), s	9.8	11.1	3.5	0.0	0.0	8.8		
Prop In Lane	1.00	1.00		0.00	0.00			
Lane Grp Cap(c), veh/h	218	198	2815	0	0	2815		
V/C Ratio(X)	0.75	0.84	0.17	0.00	0.00	0.35		
Avail Cap(c_a), veh/h	427	389	2815	0	0	2815		
HCM Platoon Ratio	1.00	1.00	1.00	1.00	1.00	1.00		
Upstream Filter(I)	1.00	1.00	1.00	0.00	0.00	1.00		
Uniform Delay (d), s/veh	46.6	47.2	2.7	0.0	0.0	3.2		
Incr Delay (d2), s/veh	2.0	3.6	0.1	0.0	0.0	0.3		
Initial Q Delay(d3),s/veh	0.0	0.0	0.0	0.0	0.0	0.0		
%ile BackOfQ(50%),veh/ln	4.9	5.1	1.7	0.0	0.0	4.4		
LnGrp Delay(d),s/veh	48.6	50.8	2.8	0.0	0.0	3.5		
LnGrp LOS	D	D	A			A		
Approach Vol, veh/h	330		476			991		
Approach Delay, s/veh	49.7		2.8			3.5		
Approach LOS	D		A			A		
Timer	1	2	3	4	5	6	7	8
Assigned Phs		2				6		8
Phs Duration (G+Y+Rc), s		92.0				92.0		18.0
Change Period (Y+Rc), s		4.5				4.5		4.5
Max Green Setting (Gmax), s		74.5				74.5		26.5
Max Q Clear Time (g_c+I1), s		5.5				10.8		13.1
Green Ext Time (p_c), s		2.5				6.2		0.4
Intersection Summary								
HCM 2010 Ctrl Delay			11.8					
HCM 2010 LOS			B					
Notes								





















11: Lakeshore Ave & MacArthur Blvd
 HCM 2010 Signalized Intersection Summary

03/14/2019

												
Movement	EBL	EBT	EBR	WBL	WBT	WBR	NBL	NBT	NBR	SBL	SBT	SBR
Lane Configurations												
Traffic Volume (veh/h)	245	659	168	0	0	0	0	464	233	288	443	0
Future Volume (veh/h)	245	659	168	0	0	0	0	464	233	288	443	0
Number	7	4	14				5	2	12	1	6	16
Initial Q (Qb), veh	0	0	0				0	0	0	0	0	0
Ped-Bike Adj(A_pbT)	1.00		0.89				1.00		0.97	1.00		1.00
Parking Bus, Adj	1.00	1.00	1.00				1.00	1.00	1.00	1.00	1.00	1.00
Adj Sat Flow, veh/h/ln	1863	1863	1863				0	1863	1900	1863	1863	0
Adj Flow Rate, veh/h	226	686	103				0	464	233	288	443	0
Adj No. of Lanes	1	3	1				0	2	0	1	2	0
Peak Hour Factor	1.00	1.00	1.00				1.00	1.00	1.00	1.00	1.00	1.00
Percent Heavy Veh, %	2	2	2				0	2	2	2	2	0
Cap, veh/h	422	1328	337				0	853	425	465	2397	0
Arrive On Green	0.24	0.24	0.24				0.00	0.38	0.38	0.35	0.90	0.00
Sat Flow, veh/h	1774	5588	1416				0	2353	1126	1774	3632	0
Grp Volume(v), veh/h	226	686	103				0	362	335	288	443	0
Grp Sat Flow(s),veh/h/ln	1774	1863	1416				0	1770	1616	1774	1770	0
Q Serve(g_s), s	11.8	11.3	6.3				0.0	17.0	17.2	14.3	1.6	0.0
Cycle Q Clear(g_c), s	11.8	11.3	6.3				0.0	17.0	17.2	14.3	1.6	0.0
Prop In Lane	1.00		1.00				0.00		0.70	1.00		0.00
Lane Grp Cap(c), veh/h	422	1328	337				0	668	610	465	2397	0
V/C Ratio(X)	0.54	0.52	0.31				0.00	0.54	0.55	0.62	0.18	0.00
Avail Cap(c_a), veh/h	485	1529	387				0	668	610	465	2397	0
HCM Platoon Ratio	1.00	1.00	1.00				1.00	1.00	1.00	1.33	1.33	1.00
Upstream Filter(I)	1.00	1.00	1.00				0.00	1.00	1.00	0.83	0.83	0.00
Uniform Delay (d), s/veh	35.3	35.1	33.2				0.0	25.8	25.9	30.1	1.8	0.0
Incr Delay (d2), s/veh	0.4	0.1	0.2				0.0	3.2	3.5	1.5	0.1	0.0
Initial Q Delay(d3),s/veh	0.0	0.0	0.0				0.0	0.0	0.0	0.0	0.0	0.0
%ile BackOfQ(50%),veh/ln	5.8	5.9	2.5				0.0	8.8	8.2	7.2	0.8	0.0
LnGrp Delay(d),s/veh	35.7	35.2	33.4				0.0	29.0	29.4	31.6	1.9	0.0
LnGrp LOS	D	D	C					C	C	C	A	
Approach Vol, veh/h		1015						697			731	
Approach Delay, s/veh		35.1						29.2			13.6	
Approach LOS		D						C			B	
Timer	1	2	3	4	5	6	7	8				
Assigned Phs	1	2		4		6						
Phs Duration (G+Y+Rc), s	31.8	44.0		30.2		75.8						
Change Period (Y+Rc), s	4.0	* 4		5.0		4.0						
Max Green Setting (Gmax), s	24.5	* 40		29.0		68.0						
Max Q Clear Time (g_c+I1), s	16.3	19.2		13.8		3.6						
Green Ext Time (p_c), s	0.3	3.2		3.5		2.3						
Intersection Summary												
HCM 2010 Ctrl Delay			27.0									
HCM 2010 LOS			C									
Notes												

12: Lakeshore Ave & Lake Park Ave
 HCM 2010 Signalized Intersection Summary

03/14/2019

												
Movement	EBL	EBT	EBR	WBL	WBT	WBR	NBL	NBT	NBR	SBL	SBT	SBR
Lane Configurations												
Traffic Volume (veh/h)	39	0	54	348	641	191	332	374	0	0	337	235
Future Volume (veh/h)	39	0	54	348	641	191	332	374	0	0	337	235
Number	7	4	14	3	8	18	5	2	12	1	6	16
Initial Q (Qb), veh	0	0	0	0	0	0	0	0	0	0	0	0
Ped-Bike Adj(A_pbT)	1.00		0.98	1.00		1.00	1.00		1.00	1.00		0.80
Parking Bus, Adj	1.00	1.00	1.00	1.00	1.00	1.00	1.00	1.00	1.00	1.00	1.00	1.00
Adj Sat Flow, veh/h/ln	1863	1863	1900	1900	1863	1863	1863	1863	0	0	1863	1900
Adj Flow Rate, veh/h	39	0	54	348	641	0	332	374	0	0	337	235
Adj No. of Lanes	1	1	0	0	2	1	2	1	0	0	2	0
Peak Hour Factor	1.00	1.00	1.00	1.00	1.00	1.00	1.00	1.00	1.00	1.00	1.00	1.00
Percent Heavy Veh, %	2	2	2	2	2	2	2	2	0	0	2	2
Cap, veh/h	110	0	96	317	626	418	697	992	0	0	530	351
Arrive On Green	0.06	0.00	0.06	0.26	0.26	0.00	0.40	1.00	0.00	0.00	0.29	0.29
Sat Flow, veh/h	1774	0	1548	1201	2371	1583	3442	1863	0	0	1934	1219
Grp Volume(v), veh/h	39	0	54	522	467	0	332	374	0	0	323	249
Grp Sat Flow(s),veh/h/ln	1774	0	1548	1803	1770	1583	1721	1863	0	0	1770	1290
Q Serve(g_s), s	2.2	0.0	3.6	28.0	27.9	0.0	7.5	0.0	0.0	0.0	16.9	18.0
Cycle Q Clear(g_c), s	2.2	0.0	3.6	28.0	27.9	0.0	7.5	0.0	0.0	0.0	16.9	18.0
Prop In Lane	1.00		1.00	0.67		1.00	1.00		0.00	0.00		0.95
Lane Grp Cap(c), veh/h	110	0	96	476	467	418	697	992	0	0	509	371
V/C Ratio(X)	0.36	0.00	0.56	1.10	1.00	0.00	0.48	0.38	0.00	0.00	0.64	0.67
Avail Cap(c_a), veh/h	209	0	183	476	467	418	697	992	0	0	509	371
HCM Platoon Ratio	1.00	1.00	1.00	1.00	1.00	1.00	2.00	2.00	1.00	1.00	1.00	1.00
Upstream Filter(I)	1.00	0.00	1.00	1.00	1.00	0.00	0.85	0.85	0.00	0.00	1.00	1.00
Uniform Delay (d), s/veh	47.7	0.0	48.3	39.0	39.0	0.0	27.4	0.0	0.0	0.0	32.9	33.3
Incr Delay (d2), s/veh	0.7	0.0	1.9	70.2	41.2	0.0	0.2	0.9	0.0	0.0	5.9	9.3
Initial Q Delay(d3),s/veh	0.0	0.0	0.0	0.0	0.0	0.0	0.0	0.0	0.0	0.0	0.0	0.0
%ile BackOfQ(50%),veh/ln	1.1	0.0	1.6	23.2	19.0	0.0	3.5	0.3	0.0	0.0	9.1	7.4
LnGrp Delay(d),s/veh	48.4	0.0	50.3	109.2	80.2	0.0	27.6	0.9	0.0	0.0	38.8	42.6
LnGrp LOS	D		D	F	F		C	A			D	D
Approach Vol, veh/h		93			989			706			572	
Approach Delay, s/veh		49.5			95.5			13.5			40.5	
Approach LOS		D			F			B			D	
Timer	1	2	3	4	5	6	7	8				
Assigned Phs		2		4	5	6		8				
Phs Duration (G+Y+Rc), s		61.0		12.0	26.0	35.0		33.0				
Change Period (Y+Rc), s		4.5		5.5	4.5	* 4.5		5.0				
Max Green Setting (Gmax), s		50.5		12.5	16.0	* 31		28.0				
Max Q Clear Time (g_c+I1), s		2.0		5.6	9.5	20.0		30.0				
Green Ext Time (p_c), s		1.7		0.1	0.4	2.1		0.0				
Intersection Summary												
HCM 2010 Ctrl Delay				55.8								
HCM 2010 LOS				E								
Notes												

Intersection	
Intersection Delay, s/veh	5
Intersection LOS	A




















Movement	EBL	EBT	WBT	WBR	SBL	SBR
Lane Configurations		↕	↔			
Traffic Vol, veh/h	385	258	414	101	0	0
Future Vol, veh/h	385	258	414	101	0	0
Peak Hour Factor	1.00	1.00	1.00	1.00	1.00	1.00
Heavy Vehicles, %	4	4	4	4	4	4
Mvmt Flow	385	258	414	101	0	0
Number of Lanes	0	1	1	0	0	0

Approach	EB	WB
Opposing Approach	WB	EB
Opposing Lanes	1	1
Conflicting Approach Left		
Conflicting Lanes Left	0	0
Conflicting Approach Right		
Conflicting Lanes Right	0	0
HCM Control Delay	5	5
HCM LOS	A	A

Lane	EBLn1	WBLn1
Vol Left, %	60%	0%
Vol Thru, %	40%	80%
Vol Right, %	0%	20%
Sign Control	Stop	Stop
Traffic Vol by Lane	643	515
LT Vol	385	0
Through Vol	258	414
RT Vol	0	101
Lane Flow Rate	643	515
Geometry Grp	0	0
Degree of Util (X)	0	0
Departure Headway (Hd)	0	0
Convergence, Y/N	Yes	Yes
Cap	0	0
Service Time	0	0
HCM Lane V/C Ratio	0	0
HCM Control Delay	5	5
HCM Lane LOS	N	N
HCM 95th-tile Q	0	0



















14: 5th Ave & E 8th St
 HCM 2010 Signalized Intersection Summary

03/14/2019

												
Movement	EBL	EBT	EBR	WBL	WBT	WBR	NBL	NBT	NBR	SBL	SBT	SBR
Lane Configurations												
Traffic Volume (veh/h)	82	206	44	76	527	1	56	199	29	7	315	142
Future Volume (veh/h)	82	206	44	76	527	1	56	199	29	7	315	142
Number	7	4	14	3	8	18	5	2	12	1	6	16
Initial Q (Qb), veh	0	0	0	0	0	0	0	0	0	0	0	0
Ped-Bike Adj(A_pbT)	1.00		0.97	0.99		0.97	1.00		0.98	1.00		0.98
Parking Bus, Adj	1.00	1.00	1.00	1.00	1.00	1.00	1.00	1.00	1.00	1.00	1.00	1.00
Adj Sat Flow, veh/h/ln	1845	1845	1845	1845	1845	1900	1900	1845	1900	1900	1845	1900
Adj Flow Rate, veh/h	82	206	19	76	527	1	56	199	29	7	315	142
Adj No. of Lanes	1	3	1	1	2	0	0	1	0	0	1	0
Peak Hour Factor	1.00	1.00	1.00	1.00	1.00	1.00	1.00	1.00	1.00	1.00	1.00	1.00
Percent Heavy Veh, %	3	3	3	3	3	3	3	3	3	3	3	3
Cap, veh/h	385	2120	641	558	1511	3	174	580	78	58	567	251
Arrive On Green	0.42	0.42	0.42	0.42	0.42	0.42	0.47	0.47	0.47	0.47	0.47	0.47
Sat Flow, veh/h	861	5036	1522	1134	3589	7	230	1225	165	7	1197	531
Grp Volume(v), veh/h	82	206	19	76	257	271	284	0	0	464	0	0
Grp Sat Flow(s),veh/h/ln	861	1679	1522	1134	1752	1843	1621	0	0	1735	0	0
Q Serve(g_s), s	4.8	1.6	0.5	2.9	6.6	6.6	0.0	0.0	0.0	0.0	0.0	0.0
Cycle Q Clear(g_c), s	11.4	1.6	0.5	4.5	6.6	6.6	6.5	0.0	0.0	12.7	0.0	0.0
Prop In Lane	1.00		1.00	1.00		0.00	0.20		0.10	0.02		0.31
Lane Grp Cap(c), veh/h	385	2120	641	558	738	776	832	0	0	877	0	0
V/C Ratio(X)	0.21	0.10	0.03	0.14	0.35	0.35	0.34	0.00	0.00	0.53	0.00	0.00
Avail Cap(c_a), veh/h	385	2120	641	558	738	776	832	0	0	877	0	0
HCM Platoon Ratio	1.00	1.00	1.00	1.00	1.00	1.00	1.00	1.00	1.00	1.00	1.00	1.00
Upstream Filter(I)	1.00	1.00	1.00	1.00	1.00	1.00	1.00	0.00	0.00	1.00	0.00	0.00
Uniform Delay (d), s/veh	16.9	11.6	11.3	13.0	13.1	13.1	10.9	0.0	0.0	12.6	0.0	0.0
Incr Delay (d2), s/veh	1.3	0.1	0.1	0.5	1.3	1.2	1.1	0.0	0.0	2.3	0.0	0.0
Initial Q Delay(d3),s/veh	0.0	0.0	0.0	0.0	0.0	0.0	0.0	0.0	0.0	0.0	0.0	0.0
%ile BackOfQ(50%),veh/ln	1.3	0.8	0.2	1.0	3.4	3.6	3.5	0.0	0.0	6.6	0.0	0.0
LnGrp Delay(d),s/veh	18.2	11.7	11.4	13.5	14.4	14.3	12.0	0.0	0.0	14.8	0.0	0.0
LnGrp LOS	B	B	B	B	B	B	B			B		
Approach Vol, veh/h		307			604			284				464
Approach Delay, s/veh		13.4			14.2			12.0				14.8
Approach LOS		B			B			B				B
Timer	1	2	3	4	5	6	7	8				
Assigned Phs		2		4		6		8				
Phs Duration (G+Y+Rc), s		35.0		31.5		35.0		31.5				
Change Period (Y+Rc), s		3.5		3.5		3.5		3.5				
Max Green Setting (Gmax), s		31.5		28.0		31.5		28.0				
Max Q Clear Time (g_c+I1), s		8.5		13.4		14.7		8.6				
Green Ext Time (p_c), s		1.8		1.4		2.8		3.2				
Intersection Summary												
HCM 2010 Ctrl Delay				13.9								
HCM 2010 LOS				B								

15: E 8th St/14th Ave & E 12th St
 HCM 2010 Signalized Intersection Summary

03/14/2019

												
Movement	EBL	EBT	EBR	WBL	WBT	WBR	NBL	NBT	NBR	SBL	SBT	SBR
Lane Configurations												
Traffic Volume (veh/h)	106	144	7	0	0	0	0	132	0	244	274	0
Future Volume (veh/h)	106	144	7	0	0	0	0	132	0	244	274	0
Number	1	6	16				7	4	14	3	8	18
Initial Q (Qb), veh	0	0	0				0	0	0	0	0	0
Ped-Bike Adj(A_pbT)	1.00		1.00				1.00		1.00	1.00		1.00
Parking Bus, Adj	1.00	1.00	1.00				1.00	1.00	1.00	1.00	1.00	1.00
Adj Sat Flow, veh/h/ln	1863	1863	1900				0	1863	0	1863	1863	0
Adj Flow Rate, veh/h	106	144	0				0	132	0	244	274	0
Adj No. of Lanes	1	2	0				0	2	0	1	3	0
Peak Hour Factor	1.00	1.00	1.00				1.00	1.00	1.00	1.00	1.00	1.00
Percent Heavy Veh, %	2	2	2				0	2	0	2	2	0
Cap, veh/h	519	1035	0				0	762	0	861	2816	0
Arrive On Green	0.29	0.29	0.00				0.00	0.22	0.00	0.29	0.55	0.00
Sat Flow, veh/h	1774	3632	0				0	3725	0	1774	5253	0
Grp Volume(v), veh/h	106	144	0				0	132	0	244	274	0
Grp Sat Flow(s),veh/h/ln	1774	1770	0				0	1770	0	1774	1695	0
Q Serve(g_s), s	2.9	2.0	0.0				0.0	2.0	0.0	4.8	1.7	0.0
Cycle Q Clear(g_c), s	2.9	2.0	0.0				0.0	2.0	0.0	4.8	1.7	0.0
Prop In Lane	1.00		0.00				0.00		0.00	1.00		0.00
Lane Grp Cap(c), veh/h	519	1035	0				0	762	0	861	2816	0
V/C Ratio(X)	0.20	0.14	0.00				0.00	0.17	0.00	0.28	0.10	0.00
Avail Cap(c_a), veh/h	519	1035	0				0	762	0	861	2816	0
HCM Platoon Ratio	1.00	1.00	1.00				1.00	1.00	1.00	1.00	1.00	1.00
Upstream Filter(l)	1.00	1.00	0.00				0.00	1.00	0.00	1.00	1.00	0.00
Uniform Delay (d), s/veh	17.3	17.0	0.0				0.0	20.8	0.0	8.2	6.8	0.0
Incr Delay (d2), s/veh	0.9	0.3	0.0				0.0	0.5	0.0	0.8	0.1	0.0
Initial Q Delay(d3),s/veh	0.0	0.0	0.0				0.0	0.0	0.0	0.0	0.0	0.0
%ile BackOfQ(50%),veh/ln	1.5	1.0	0.0				0.0	1.0	0.0	2.4	0.8	0.0
LnGrp Delay(d),s/veh	18.2	17.2	0.0				0.0	21.3	0.0	9.0	6.9	0.0
LnGrp LOS	B	B						C		A	A	
Approach Vol, veh/h		250						132			518	
Approach Delay, s/veh		17.7						21.3			7.9	
Approach LOS		B						C			A	
Timer	1	2	3	4	5	6	7	8				
Assigned Phs			3	4		6		8				
Phs Duration (G+Y+Rc), s			22.0	19.0		24.0		41.0				
Change Period (Y+Rc), s			3.0	5.0		5.0		5.0				
Max Green Setting (Gmax), s			19.0	14.0		19.0		36.0				
Max Q Clear Time (g_c+I1), s			6.8	4.0		4.9		3.7				
Green Ext Time (p_c), s			0.0	0.1		0.1		0.4				
Intersection Summary												
HCM 2010 Ctrl Delay			12.6									
HCM 2010 LOS			B									

16: Foothill & 14th Ave
 HCM Signalized Intersection Capacity Analysis

03/14/2019



Movement	EBL	EBT	EBR	WBL	WBT	WBR	NBL	NBT	NBR	SBL	SBT	SBR
Lane Configurations					↑↑						↑↑	
Traffic Volume (vph)	0	0	0	70	296	0	0	0	0	88	897	162
Future Volume (vph)	0	0	0	70	296	0	0	0	0	88	897	162
Ideal Flow (vphpl)	1900	1900	1900	1900	1900	1900	1900	1900	1900	1900	1900	1900
Total Lost time (s)					5.5						4.0	
Lane Util. Factor					0.95						0.95	
Frbp, ped/bikes					1.00						1.00	
Flpb, ped/bikes					1.00						1.00	
Frt					1.00						0.98	
Flt Protected					0.99						1.00	
Satd. Flow (prot)					3506						3438	
Flt Permitted					0.99						1.00	
Satd. Flow (perm)					3506						3438	
Peak-hour factor, PHF	1.00	1.00	1.00	1.00	1.00	1.00	1.00	1.00	1.00	1.00	1.00	1.00
Adj. Flow (vph)	0	0	0	70	296	0	0	0	0	88	897	162
RTOR Reduction (vph)	0	0	0	0	0	0	0	0	0	0	15	0
Lane Group Flow (vph)	0	0	0	0	366	0	0	0	0	0	1132	0
Confl. Peds. (#/hr)	20		12			20	12					12
Confl. Bikes (#/hr)						16						8
Turn Type				Split	NA					Split	NA	
Protected Phases				5	5					6	6	
Permitted Phases												
Actuated Green, G (s)					7.4						33.0	
Effective Green, g (s)					7.4						33.0	
Actuated g/C Ratio					0.11						0.51	
Clearance Time (s)					5.5						4.0	
Vehicle Extension (s)					0.2						0.2	
Lane Grp Cap (vph)					399						1745	
v/s Ratio Prot					c0.10						c0.33	
v/s Ratio Perm												
v/c Ratio					0.92						0.65	
Uniform Delay, d1					28.5						11.7	
Progression Factor					1.72						1.00	
Incremental Delay, d2					24.3						1.9	
Delay (s)					73.3						13.6	
Level of Service					E						B	
Approach Delay (s)		0.0			73.3			0.0			13.6	
Approach LOS		A			E			A			B	
Intersection Summary												
HCM 2000 Control Delay			28.1		HCM 2000 Level of Service						C	
HCM 2000 Volume to Capacity ratio			0.56									
Actuated Cycle Length (s)			65.0		Sum of lost time (s)					15.0		
Intersection Capacity Utilization			54.1%		ICU Level of Service					A		
Analysis Period (min)			15									

c Critical Lane Group

17: 14th Ave & Foothill Blvd
 HCM Signalized Intersection Capacity Analysis

03/14/2019



Movement	EBL	EBT	EBR	WBL	WBT	WBR	NBL	NBT	NBR	SBL	SBT	SBR	
Lane Configurations		↑↑			↑↑			↑↑					
Traffic Volume (vph)	2	86	0	0	366	1	0	399	98	0	0	0	
Future Volume (vph)	2	86	0	0	366	1	0	399	98	0	0	0	
Ideal Flow (vphpl)	1900	1900	1900	1900	1900	1900	1900	1900	1900	1900	1900	1900	
Total Lost time (s)		5.5			5.5			4.0					
Lane Util. Factor		0.95			0.95			0.95					
Frb, ped/bikes		1.00			1.00			1.00					
Flpb, ped/bikes		1.00			1.00			1.00					
Frt		1.00			1.00			0.97					
Flt Protected		1.00			1.00			1.00					
Satd. Flow (prot)		3501			3503			3390					
Flt Permitted		0.95			1.00			1.00					
Satd. Flow (perm)		3332			3503			3390					
Peak-hour factor, PHF	1.00	1.00	1.00	1.00	1.00	1.00	1.00	1.00	1.00	1.00	1.00	1.00	
Adj. Flow (vph)	2	86	0	0	366	1	0	399	98	0	0	0	
RTOR Reduction (vph)	0	0	0	0	0	0	0	22	0	0	0	0	
Lane Group Flow (vph)	0	88	0	0	367	0	0	475	0	0	0	0	
Confl. Peds. (#/hr)			7	7		17			2	2			
Confl. Bikes (#/hr)			1			13			5				
Heavy Vehicles (%)	3%	3%	3%	3%	3%	3%	3%	3%	3%	3%	3%	3%	
Turn Type	custom	NA			NA			NA					
Protected Phases	1	4	1		8			2					
Permitted Phases	4												
Actuated Green, G (s)		14.1			9.6			36.9					
Effective Green, g (s)		14.1			9.6			36.9					
Actuated g/C Ratio		0.22			0.15			0.57					
Clearance Time (s)					5.5			4.0					
Vehicle Extension (s)					0.2			0.2					
Lane Grp Cap (vph)		734			517			1924					
v/s Ratio Prot		c0.01			c0.10			c0.14					
v/s Ratio Perm		0.02											
v/c Ratio		0.12			0.71			0.25					
Uniform Delay, d1		20.5			26.4			7.1					
Progression Factor		1.91			1.00			1.00					
Incremental Delay, d2		0.0			3.6			0.3					
Delay (s)		39.1			30.0			7.4					
Level of Service		D			C			A					
Approach Delay (s)		39.1			30.0			7.4			0.0		
Approach LOS		D			C			A			A		
Intersection Summary													
HCM 2000 Control Delay			19.0									HCM 2000 Level of Service	B
HCM 2000 Volume to Capacity ratio			0.33										
Actuated Cycle Length (s)			65.0									Sum of lost time (s)	15.0
Intersection Capacity Utilization			34.2%									ICU Level of Service	A
Analysis Period (min)			15										
c	Critical Lane Group												

18: 23rd Ave & 16th St
 HCM Signalized Intersection Capacity Analysis

03/14/2019



Movement	WBL	WBR	NBT	NBR	SBL	SBT
Lane Configurations						
Traffic Volume (vph)	7	57	186	10	24	386
Future Volume (vph)	7	57	186	10	24	386
Ideal Flow (vphpl)	1900	1900	1900	1900	1900	1900
Total Lost time (s)	4.0		4.0			4.0
Lane Util. Factor	1.00		1.00			1.00
Frbp, ped/bikes	0.97		1.00			1.00
Flpb, ped/bikes	1.00		1.00			1.00
Frt	0.88		0.99			1.00
Flt Protected	0.99		1.00			1.00
Satd. Flow (prot)	1571		1826			1836
Flt Permitted	0.99		1.00			0.98
Satd. Flow (perm)	1571		1826			1804
Peak-hour factor, PHF	1.00	1.00	1.00	1.00	1.00	1.00
Adj. Flow (vph)	7	57	186	10	24	386
RTOR Reduction (vph)	49	0	2	0	0	0
Lane Group Flow (vph)	15	0	194	0	0	410
Confl. Peds. (#/hr)		2		33	33	
Confl. Bikes (#/hr)		1		2		
Heavy Vehicles (%)	3%	3%	3%	3%	3%	3%
Turn Type	Prot		NA		Perm	NA
Protected Phases	7		2			2
Permitted Phases					2	
Actuated Green, G (s)	6.7		22.8			22.8
Effective Green, g (s)	6.7		22.8			22.8
Actuated g/C Ratio	0.14		0.46			0.46
Clearance Time (s)	4.0		4.0			4.0
Vehicle Extension (s)	3.0		3.0			3.0
Lane Grp Cap (vph)	212		839			829
v/s Ratio Prot	c0.01		0.11			
v/s Ratio Perm						c0.23
v/c Ratio	0.07		0.23			0.49
Uniform Delay, d1	18.7		8.1			9.4
Progression Factor	1.00		1.00			0.19
Incremental Delay, d2	0.1		0.1			0.4
Delay (s)	18.9		8.2			2.2
Level of Service	B		A			A
Approach Delay (s)	18.9		8.2			2.2
Approach LOS	B		A			A

Intersection Summary

HCM 2000 Control Delay	5.5	HCM 2000 Level of Service	A
HCM 2000 Volume to Capacity ratio	0.31		
Actuated Cycle Length (s)	49.6	Sum of lost time (s)	12.0
Intersection Capacity Utilization	49.9%	ICU Level of Service	A
Analysis Period (min)	15		

c Critical Lane Group

Intersection						
Int Delay, s/veh	8.1					
Movement	EBL	EBR	NBL	NBT	SBT	SBR
Lane Configurations	↔		↔	↑	↑	
Traffic Vol, veh/h	138	43	53	362	532	31
Future Vol, veh/h	138	43	53	362	532	31
Conflicting Peds, #/hr	0	0	39	0	0	39
Sign Control	Stop	Stop	Free	Free	Free	Free
RT Channelized	-	None	-	None	-	None
Storage Length	0	-	0	-	-	-
Veh in Median Storage, #	0	-	-	0	0	-
Grade, %	0	-	-	0	0	-
Peak Hour Factor	100	100	100	100	100	100
Heavy Vehicles, %	2	2	2	2	2	2
Mvmt Flow	138	43	53	362	532	31

Major/Minor	Minor2	Major1	Major2			
Conflicting Flow All	1055	587	602	0	-	0
Stage 1	587	-	-	-	-	-
Stage 2	468	-	-	-	-	-
Critical Hdwy	6.42	6.22	4.12	-	-	-
Critical Hdwy Stg 1	5.42	-	-	-	-	-
Critical Hdwy Stg 2	5.42	-	-	-	-	-
Follow-up Hdwy	3.518	3.318	2.218	-	-	-
Pot Cap-1 Maneuver	250	510	975	-	-	-
Stage 1	556	-	-	-	-	-
Stage 2	630	-	-	-	-	-
Platoon blocked, %				-	-	-
Mov Cap-1 Maneuver	219	491	939	-	-	-
Mov Cap-2 Maneuver	219	-	-	-	-	-
Stage 1	505	-	-	-	-	-
Stage 2	607	-	-	-	-	-

Approach	EB	NB	SB
HCM Control Delay, s	48.8	1.2	0
HCM LOS	E		

Minor Lane/Major Mvmt	NBL	NBT	EBLn1	SBT	SBR
Capacity (veh/h)	939	-	252	-	-
HCM Lane V/C Ratio	0.056	-	0.718	-	-
HCM Control Delay (s)	9.1	-	48.8	-	-
HCM Lane LOS	A	-	E	-	-
HCM 95th %tile Q(veh)	0.2	-	4.9	-	-

2: Broadway & 5th Street HCM Signalized Intersection Capacity Analysis

03/14/2019



Movement	EBL	EBT	EBR	EBR2	NBT	NBR	NBR2	SBL2	SBL	SBT
Lane Configurations		↕↕	↗	↗	↕↕	↘			↘	↕↕
Traffic Volume (vph)	5	329	791	17	239	50	381	361	144	232
Future Volume (vph)	5	329	791	17	239	50	381	361	144	232
Ideal Flow (vphpl)	1900	1900	1900	1900	1900	1900	1900	1900	1900	1900
Total Lost time (s)		5.5	5.5	5.5	4.5	4.5			4.5	4.5
Lane Util. Factor		0.91	0.91	1.00	0.95	1.00			0.91	0.91
Frbp, ped/bikes		1.00	1.00	0.98	1.00	0.84			1.00	1.00
Flpb, ped/bikes		1.00	1.00	1.00	1.00	1.00			1.00	0.98
Frt		0.92	0.85	0.85	1.00	0.85			1.00	1.00
Flt Protected		1.00	1.00	1.00	1.00	1.00			0.95	0.98
Satd. Flow (prot)		2696	1248	1344	3065	1145			1395	2838
Flt Permitted		1.00	1.00	1.00	1.00	1.00			0.95	0.77
Satd. Flow (perm)		2696	1248	1344	3065	1145			1395	2227
Peak-hour factor, PHF	1.00	1.00	1.00	1.00	1.00	1.00	1.00	1.00	1.00	1.00
Adj. Flow (vph)	5	329	791	17	239	50	381	361	144	232
RTOR Reduction (vph)	0	0	0	11	0	189	0	0	0	0
Lane Group Flow (vph)	0	730	395	6	239	242	0	0	375	362
Confl. Peds. (#/hr)				5		65			65	
Confl. Bikes (#/hr)				1		6				
Heavy Vehicles (%)	6%	6%	6%	6%	6%	6%	6%	6%	6%	6%
Turn Type	Perm	NA	Prot	Perm	NA	Perm		Prot	Prot	NA
Protected Phases		4	4		2			1	1	6
Permitted Phases	4			4		2				
Actuated Green, G (s)		31.0	31.0	31.0	20.4	20.4			24.1	49.0
Effective Green, g (s)		31.0	31.0	31.0	20.4	20.4			24.1	49.0
Actuated g/C Ratio		0.34	0.34	0.34	0.23	0.23			0.27	0.54
Clearance Time (s)		5.5	5.5	5.5	4.5	4.5			4.5	4.5
Vehicle Extension (s)		2.0	2.0	2.0	2.0	2.0			2.0	2.0
Lane Grp Cap (vph)		928	429	462	694	259			373	1376
v/s Ratio Prot			c0.32		0.08				c0.27	0.07
v/s Ratio Perm		0.27		0.00		c0.21				0.07
v/c Ratio		0.88dr	0.92	0.01	0.34	0.93			1.01	0.26
Uniform Delay, d1		26.5	28.3	19.4	29.2	34.1			33.0	10.9
Progression Factor		1.00	1.00	1.00	1.00	1.00			1.00	1.00
Incremental Delay, d2		4.1	24.7	0.0	0.1	37.5			47.9	0.5
Delay (s)		30.6	53.0	19.4	29.3	71.7			80.9	11.4
Level of Service		C	D	B	C	E			F	B
Approach Delay (s)		38.2			56.6					46.7
Approach LOS		D			E					D

Intersection Summary

HCM 2000 Control Delay	45.5	HCM 2000 Level of Service	D
HCM 2000 Volume to Capacity ratio	0.95		
Actuated Cycle Length (s)	90.0	Sum of lost time (s)	14.5
Intersection Capacity Utilization	105.0%	ICU Level of Service	G
Analysis Period (min)	15		

dr Defacto Right Lane. Recode with 1 though lane as a right lane.

c Critical Lane Group

3: 6th Street & Jackson St
 HCM Signalized Intersection Capacity Analysis

03/14/2019



Movement	WBL	WBT	WBR2	NBL2	NBT	SBT	SBR	SER2
Lane Configurations	↶	↑	↷	↶	↑	↷		↷
Traffic Volume (vph)	8	303	83	244	500	150	286	999
Future Volume (vph)	8	303	83	244	500	150	286	999
Ideal Flow (vphpl)	1900	1900	1900	1900	1900	1900	1900	1900
Total Lost time (s)	5.5	5.5	5.5	5.5	5.5	5.5		5.5
Lane Util. Factor	1.00	1.00	1.00	1.00	1.00	1.00		1.00
Frpb, ped/bikes	1.00	1.00	0.99	1.00	1.00	0.98		1.00
Flpb, ped/bikes	1.00	1.00	1.00	1.00	1.00	1.00		1.00
Frt	1.00	1.00	0.85	1.00	1.00	0.91		0.86
Flt Protected	0.95	1.00	1.00	0.95	1.00	1.00		1.00
Satd. Flow (prot)	1601	1693	1419	1604	1693	1513		1450
Flt Permitted	0.95	1.00	1.00	0.46	1.00	1.00		1.00
Satd. Flow (perm)	1601	1693	1419	773	1693	1513		1450
Peak-hour factor, PHF	1.00	1.00	1.00	1.00	1.00	1.00	1.00	0.92
Adj. Flow (vph)	8	303	83	244	500	150	286	1086
RTOR Reduction (vph)	0	0	61	0	0	0	0	0
Lane Group Flow (vph)	8	303	22	244	500	436	0	1086
Confl. Peds. (#/hr)	2			5				5
Confl. Bikes (#/hr)			2					7
Heavy Vehicles (%)	1%	1%	1%	1%	1%	1%	1%	2%
Turn Type	Perm	NA	Perm	Perm	NA	NA		Perm
Protected Phases		8			2	6		
Permitted Phases	8		8	2				6 8
Actuated Green, G (s)	19.2	19.2	19.2	40.8	40.8	40.8		71.0
Effective Green, g (s)	19.2	19.2	19.2	40.8	40.8	40.8		71.0
Actuated g/C Ratio	0.27	0.27	0.27	0.57	0.57	0.57		1.00
Clearance Time (s)	5.5	5.5	5.5	5.5	5.5	5.5		
Vehicle Extension (s)	3.0	3.0	3.0	3.0	3.0	3.0		
Lane Grp Cap (vph)	432	457	383	444	972	869		1450
v/s Ratio Prot		0.18			0.30	0.29		
v/s Ratio Perm	0.00		0.02	0.32				c0.75
v/c Ratio	0.02	0.66	0.06	0.55	0.51	0.50		0.75
Uniform Delay, d1	19.0	23.0	19.2	9.4	9.1	9.0		0.0
Progression Factor	1.00	1.00	1.00	1.00	1.00	1.00		1.00
Incremental Delay, d2	0.0	3.6	0.1	4.8	1.9	2.1		2.2
Delay (s)	19.0	26.6	19.3	14.2	11.1	11.1		2.2
Level of Service	B	C	B	B	B	B		A
Approach Delay (s)		24.9			12.1	11.1		
Approach LOS		C			B	B		

Intersection Summary

HCM 2000 Control Delay	9.8	HCM 2000 Level of Service	A
HCM 2000 Volume to Capacity ratio	0.89		
Actuated Cycle Length (s)	71.0	Sum of lost time (s)	11.0
Intersection Capacity Utilization	148.6%	ICU Level of Service	H
Analysis Period (min)	15		
c Critical Lane Group			

Intersection												
Int Delay, s/veh	4.5											
Movement	EBL	EBT	EBR	WBL	WBT	WBR	NBL	NBT	NBR	SBL	SBT	SBR
Lane Configurations		↕	↗		↕			↕			↕	
Traffic Vol, veh/h	14	525	2	6	363	319	1	10	10	952	18	21
Future Vol, veh/h	14	525	2	6	363	319	1	10	10	952	18	21
Conflicting Peds, #/hr	0	0	11	11	0	0	15	0	3	3	0	15
Sign Control	Stop	Stop	Stop	Stop	Stop	Stop	Free	Free	Free	Free	Free	Free
RT Channelized	-	-	None	-	-	None	-	-	None	-	-	None
Storage Length	-	-	100	-	-	-	-	-	-	-	-	-
Veh in Median Storage, #	-	0	-	-	0	-	-	0	-	-	0	-
Grade, %	-	0	-	-	0	-	-	0	-	-	0	-
Peak Hour Factor	100	100	100	100	100	100	100	100	100	100	100	100
Heavy Vehicles, %	2	2	2	2	2	2	2	2	2	2	2	2
Mvmt Flow	14	525	2	6	363	319	1	10	10	952	18	21

Major/Minor	Minor2		Minor1		Major1		Major2					
Conflicting Flow All	2306	1973	55	2227	1978	18	54	0	0	23	0	0
Stage 1	1948	1948	-	20	20	-	-	-	-	-	-	-
Stage 2	358	25	-	2207	1958	-	-	-	-	-	-	-
Critical Hdwy	7.12	6.52	6.22	7.12	6.52	6.22	4.12	-	-	4.12	-	-
Critical Hdwy Stg 1	6.12	5.52	-	6.12	5.52	-	-	-	-	-	-	-
Critical Hdwy Stg 2	6.12	5.52	-	6.12	5.52	-	-	-	-	-	-	-
Follow-up Hdwy	3.518	4.018	3.318	3.518	4.018	3.318	2.218	-	-	2.218	-	-
Pot Cap-1 Maneuver	27	~ 62	1012	31	~ 62	1061	1551	-	-	1592	-	-
Stage 1	83	~ 111	-	999	879	-	-	-	-	-	-	-
Stage 2	660	874	-	59	~ 110	-	-	-	-	-	-	-
Platoon blocked, %	-	-	-	-	-	-	-	-	-	-	-	-
Mov Cap-1 Maneuver	-	~ 23	987	-	~ 23	1058	1529	-	-	1587	-	-
Mov Cap-2 Maneuver	-	~ 23	-	-	~ 23	-	-	-	-	-	-	-
Stage 1	82	~ 42	-	995	875	-	-	-	-	-	-	-
Stage 2	269	871	-	-	~ 42	-	-	-	-	-	-	-

Approach	EB	WB	NB	SB
HCM Control Delay, s			0.4	10.2
HCM LOS	-	-		

Minor Lane/Major Mvmt	NBL	NBT	NBR	EBLn1	EBLn2	WBLn1	SBL	SBT	SBR
Capacity (veh/h)	1529	-	-	-	987	-	1587	-	-
HCM Lane V/C Ratio	0.001	-	-	-	0.002	-	0.6	-	-
HCM Control Delay (s)	7.4	0	-	-	8.7	-	10.6	0	-
HCM Lane LOS	A	A	-	-	A	-	B	A	-
HCM 95th %tile Q(veh)	0	-	-	-	0	-	4.3	-	-

Notes
 ~: Volume exceeds capacity \$: Delay exceeds 300s +: Computation Not Defined *: All major volume in platoon

5: Embarcadero W & 880 Off-Ramp
 HCM 2010 TWSC

03/14/2019

Intersection												
Int Delay, s/veh	6.3											
Movement	EBL	EBT	EBR	WBL	WBT	WBR	NBL	NBT	NBR	SBL	SBT	SBR
Lane Configurations		↑			↑						↑	↑
Traffic Vol, veh/h	0	1408	0	0	332	0	0	0	0	72	0	372
Future Vol, veh/h	0	1408	0	0	332	0	0	0	0	72	0	372
Conflicting Peds, #/hr	0	0	0	0	0	0	0	0	0	0	0	0
Sign Control	Free	Free	Free	Free	Free	Free	Stop	Stop	Stop	Stop	Stop	Stop
RT Channelized	-	-	None	-	-	None	-	-	None	-	-	None
Storage Length	-	-	-	-	-	-	-	-	-	-	-	0
Veh in Median Storage, #	-	0	-	-	0	-	-	-	-	-	0	-
Grade, %	-	0	-	-	0	-	-	0	-	-	0	-
Peak Hour Factor	100	100	100	100	100	100	100	100	100	100	100	100
Heavy Vehicles, %	2	2	2	2	2	2	2	2	2	2	2	2
Mvmt Flow	0	1408	0	0	332	0	0	0	0	72	0	372























Major/Minor	Major1			Major2			Minor2			
Conflicting Flow All	-	0	-	-	-	0		1740	1740	332
Stage 1	-	-	-	-	-	-		332	332	-
Stage 2	-	-	-	-	-	-		1408	1408	-
Critical Hdwy	-	-	-	-	-	-		6.42	6.52	6.22
Critical Hdwy Stg 1	-	-	-	-	-	-		5.42	5.52	-
Critical Hdwy Stg 2	-	-	-	-	-	-		5.42	5.52	-
Follow-up Hdwy	-	-	-	-	-	-		3.518	4.018	3.318
Pot Cap-1 Maneuver	0	-	0	0	-	0		96	87	710
Stage 1	0	-	0	0	-	0		727	644	-
Stage 2	0	-	0	0	-	0		226	205	-
Platoon blocked, %	-	-	-	-	-	-		-	-	-
Mov Cap-1 Maneuver	-	-	-	-	-	-		96	0	710
Mov Cap-2 Maneuver	-	-	-	-	-	-		96	0	-
Stage 1	-	-	-	-	-	-		727	0	-
Stage 2	-	-	-	-	-	-		226	0	-

Approach	EB	WB	SB
HCM Control Delay, s	0	0	31.1
HCM LOS			D

Minor Lane/Major Mvmt	EBT	WBT	SBLn1	SBLn2
Capacity (veh/h)	-	-	96	710
HCM Lane V/C Ratio	-	-	0.75	0.524
HCM Control Delay (s)	-	-	112	15.5
HCM Lane LOS	-	-	F	C
HCM 95th %tile Q(veh)	-	-	3.9	3.1

6: Webster St & Atlantic Ave
 HCM 2010 Signalized Intersection Summary

03/14/2019

												
Movement	EBL	EBT	EBR	WBL	WBT	WBR	NBL	NBT	NBR	SBL	SBT	SBR
Lane Configurations												
Traffic Volume (veh/h)	154	312	152	60	259	105	110	441	57	168	792	266
Future Volume (veh/h)	154	312	152	60	259	105	110	441	57	168	792	266
Number	7	4	14	3	8	18	5	2	12	1	6	16
Initial Q (Qb), veh	0	0	0	0	0	0	0	0	0	0	0	0
Ped-Bike Adj(A_pbT)	1.00		0.93	1.00		0.93	1.00		0.95	1.00		0.95
Parking Bus, Adj	1.00	1.00	1.00	1.00	1.00	1.00	1.00	1.00	1.00	1.00	1.00	1.00
Adj Sat Flow, veh/h/ln	1863	1863	1863	1863	1863	1900	1863	1863	1900	1863	1863	1863
Adj Flow Rate, veh/h	156	315	27	61	262	106	111	445	58	170	800	92
Adj No. of Lanes	2	2	1	1	2	0	1	2	0	1	2	1
Peak Hour Factor	0.99	0.99	0.99	0.99	0.99	0.99	0.99	0.99	0.99	0.99	0.99	0.99
Percent Heavy Veh, %	2	2	2	2	2	2	2	2	2	2	2	2
Cap, veh/h	660	678	282	366	503	196	142	840	109	212	1088	461
Arrive On Green	0.19	0.19	0.19	0.21	0.21	0.21	0.08	0.27	0.27	0.12	0.31	0.31
Sat Flow, veh/h	3442	3539	1471	1774	2437	949	1774	3131	405	1774	3539	1500
Grp Volume(v), veh/h	156	315	27	61	188	180	111	250	253	170	800	92
Grp Sat Flow(s),veh/h/ln	1721	1770	1471	1774	1770	1616	1774	1770	1766	1774	1770	1500
Q Serve(g_s), s	3.0	6.3	1.2	2.2	7.5	7.9	4.9	9.6	9.7	7.4	16.1	3.6
Cycle Q Clear(g_c), s	3.0	6.3	1.2	2.2	7.5	7.9	4.9	9.6	9.7	7.4	16.1	3.6
Prop In Lane	1.00		1.00	1.00		0.59	1.00		0.23	1.00		1.00
Lane Grp Cap(c), veh/h	660	678	282	366	366	334	142	475	474	212	1088	461
V/C Ratio(X)	0.24	0.46	0.10	0.17	0.51	0.54	0.78	0.53	0.53	0.80	0.74	0.20
Avail Cap(c_a), veh/h	1083	1114	463	558	557	509	268	602	600	424	1515	642
HCM Platoon Ratio	1.00	1.00	1.00	1.00	1.00	1.00	1.00	1.00	1.00	1.00	1.00	1.00
Upstream Filter(I)	1.00	1.00	1.00	1.00	1.00	1.00	1.00	1.00	1.00	1.00	1.00	1.00
Uniform Delay (d), s/veh	27.2	28.5	26.4	25.9	28.0	28.1	35.8	24.8	24.8	34.1	24.6	20.3
Incr Delay (d2), s/veh	0.2	0.5	0.1	0.2	1.1	1.4	8.9	0.9	0.9	6.9	1.2	0.2
Initial Q Delay(d3),s/veh	0.0	0.0	0.0	0.0	0.0	0.0	0.0	0.0	0.0	0.0	0.0	0.0
%ile BackOfQ(50%),veh/ln	1.5	3.1	0.5	1.1	3.8	3.6	2.7	4.8	4.8	4.0	8.0	1.5
LnGrp Delay(d),s/veh	27.4	29.0	26.6	26.1	29.1	29.5	44.7	25.7	25.7	41.0	25.8	20.5
LnGrp LOS	C	C	C	C	C	C	D	C	C	D	C	C
Approach Vol, veh/h		498			429			614			1062	
Approach Delay, s/veh		28.3			28.8			29.1			27.8	
Approach LOS		C			C			C			C	
Timer	1	2	3	4	5	6	7	8				
Assigned Phs	1	2		4	5	6		8				
Phs Duration (G+Y+Rc), s	13.5	26.3		19.2	10.4	29.4		20.4				
Change Period (Y+Rc), s	4.0	5.0		4.0	4.0	5.0		4.0				
Max Green Setting (Gmax), s	19.0	27.0		25.0	12.0	34.0		25.0				
Max Q Clear Time (g_c+I1), s	9.4	11.7		8.3	6.9	18.1		9.9				
Green Ext Time (p_c), s	0.3	2.8		2.6	0.1	5.6		2.2				
Intersection Summary												
HCM 2010 Ctrl Delay				28.4								
HCM 2010 LOS				C								

Intersection												
Intersection Delay, s/veh	9.2											
Intersection LOS	A											

















Movement	EBL	EBT	EBR	WBL	WBT	WBR	NBL	NBT	NBR	SBL	SBT	SBR
Lane Configurations		↕			↕			↕			↕	
Traffic Vol, veh/h	24	150	45	13	39	100	13	62	14	67	78	34
Future Vol, veh/h	24	150	45	13	39	100	13	62	14	67	78	34
Peak Hour Factor	1.00	1.00	1.00	1.00	1.00	1.00	1.00	1.00	1.00	1.00	1.00	1.00
Heavy Vehicles, %	3	3	3	3	3	3	3	3	3	3	3	3
Mvmt Flow	24	150	45	13	39	100	13	62	14	67	78	34
Number of Lanes	0	1	0	0	1	0	0	1	0	0	2	0

Approach	EB	WB	NB	SB
Opposing Approach	WB	EB	SB	NB
Opposing Lanes	1	1	2	1
Conflicting Approach Left	SB	NB	EB	WB
Conflicting Lanes Left	2	1	1	1
Conflicting Approach Right	NB	SB	WB	EB
Conflicting Lanes Right	1	2	1	1
HCM Control Delay	9.7	8.7	8.9	9.3
HCM LOS	A	A	A	A

Lane	NBLn1	EBLn1	WBLn1	SBLn1	SBLn2
Vol Left, %	15%	11%	9%	63%	0%
Vol Thru, %	70%	68%	26%	37%	53%
Vol Right, %	16%	21%	66%	0%	47%
Sign Control	Stop	Stop	Stop	Stop	Stop
Traffic Vol by Lane	89	219	152	106	73
LT Vol	13	24	13	67	0
Through Vol	62	150	39	39	39
RT Vol	14	45	100	0	34
Lane Flow Rate	89	219	152	106	73
Geometry Grp	5	2	2	7	7
Degree of Util (X)	0.126	0.287	0.192	0.171	0.105
Departure Headway (Hd)	5.098	4.72	4.536	5.819	5.171
Convergence, Y/N	Yes	Yes	Yes	Yes	Yes
Cap	697	758	786	613	688
Service Time	3.174	2.771	2.591	3.59	2.941
HCM Lane V/C Ratio	0.128	0.289	0.193	0.173	0.106
HCM Control Delay	8.9	9.7	8.7	9.8	8.6
HCM Lane LOS	A	A	A	A	A
HCM 95th-tile Q	0.4	1.2	0.7	0.6	0.4





























8: Oak St & 5th Street
 HCM 2010 Signalized Intersection Summary

03/14/2019

												
Movement	EBL	EBT	EBR	WBL	WBT	WBR	NBL	NBT	NBR	SBL	SBT	SBR
Lane Configurations												
Traffic Volume (veh/h)	421	801	87	0	0	0	0	235	194	3	19	0
Future Volume (veh/h)	421	801	87	0	0	0	0	235	194	3	19	0
Number	7	4	14				5	2	12	1	6	16
Initial Q (Qb), veh	0	0	0				0	0	0	0	0	0
Ped-Bike Adj(A_pbT)	1.00		0.98				1.00		0.94	1.00		1.00
Parking Bus, Adj	1.00	1.00	1.00				1.00	1.00	1.00	1.00	1.00	1.00
Adj Sat Flow, veh/h/ln	1660	1660	1710				0	1660	1710	1710	1660	0
Adj Flow Rate, veh/h	421	801	87				0	235	194	3	19	0
Adj No. of Lanes	1	2	0				0	1	0	0	1	0
Peak Hour Factor	1.00	1.00	1.00				1.00	1.00	1.00	1.00	1.00	1.00
Percent Heavy Veh, %	3	3	3				0	3	3	3	3	0
Cap, veh/h	779	1411	153				0	310	256	84	420	0
Arrive On Green	0.49	0.49	0.49				0.00	0.38	0.38	0.38	0.38	0.00
Sat Flow, veh/h	1581	2863	311				0	818	676	68	1110	0
Grp Volume(v), veh/h	421	441	447				0	0	429	22	0	0
Grp Sat Flow(s),veh/h/ln	1581	1577	1597				0	0	1494	1178	0	0
Q Serve(g_s), s	12.9	13.8	13.8				0.0	0.0	17.5	0.1	0.0	0.0
Cycle Q Clear(g_c), s	12.9	13.8	13.8				0.0	0.0	17.5	17.6	0.0	0.0
Prop In Lane	1.00		0.19				0.00		0.45	0.14		0.00
Lane Grp Cap(c), veh/h	779	777	787				0	0	566	504	0	0
V/C Ratio(X)	0.54	0.57	0.57				0.00	0.00	0.76	0.04	0.00	0.00
Avail Cap(c_a), veh/h	779	777	787				0	0	566	504	0	0
HCM Platoon Ratio	1.00	1.00	1.00				1.00	1.00	1.00	1.00	1.00	1.00
Upstream Filter(I)	1.00	1.00	1.00				0.00	0.00	1.00	1.00	0.00	0.00
Uniform Delay (d), s/veh	12.3	12.5	12.5				0.0	0.0	19.0	14.0	0.0	0.0
Incr Delay (d2), s/veh	2.7	3.0	3.0				0.0	0.0	9.2	0.2	0.0	0.0
Initial Q Delay(d3),s/veh	0.0	0.0	0.0				0.0	0.0	0.0	0.0	0.0	0.0
%ile BackOfQ(50%),veh/ln	6.2	6.5	6.6				0.0	0.0	8.6	0.3	0.0	0.0
LnGrp Delay(d),s/veh	14.9	15.5	15.5				0.0	0.0	28.2	14.2	0.0	0.0
LnGrp LOS	B	B	B						C	B		
Approach Vol, veh/h		1309						429			22	
Approach Delay, s/veh		15.3						28.2			14.2	
Approach LOS		B						C			B	
Timer	1	2	3	4	5	6	7	8				
Assigned Phs		2		4		6						
Phs Duration (G+Y+Rc), s		31.0		39.0		31.0						
Change Period (Y+Rc), s		4.5		4.5		4.5						
Max Green Setting (Gmax), s		26.5		34.5		26.5						
Max Q Clear Time (g_c+I1), s		19.5		15.8		19.6						
Green Ext Time (p_c), s		1.1		4.4		0.0						
Intersection Summary												
HCM 2010 Ctrl Delay			18.4									
HCM 2010 LOS			B									













9: Harrison St & Grand Ave
 HCM 2010 Signalized Intersection Summary

03/14/2019

												
Movement	EBL	EBT	EBR	WBL	WBT	WBR	NBL	NBT	NBR	SBL	SBT	SBR
Lane Configurations	 	 		 	 			  			 	
Traffic Volume (veh/h)	162	790	74	173	294	25	0	874	609	0	386	108
Future Volume (veh/h)	162	790	74	173	294	25	0	874	609	0	386	108
Number	3	8	18	7	4	14	5	2	12	1	6	16
Initial Q (Qb), veh	0	0	0	0	0	0	0	0	0	0	0	0
Ped-Bike Adj(A_pbT)	1.00		0.69	1.00		0.89	1.00		1.00	1.00		0.82
Parking Bus, Adj	1.00	1.00	1.00	1.00	1.00	1.00	1.00	1.00	1.00	1.00	1.00	1.00
Adj Sat Flow, veh/h/ln	1881	1881	1881	1881	1881	1900	0	1881	1881	0	1881	1881
Adj Flow Rate, veh/h	162	790	25	173	294	25	0	874	0	0	386	45
Adj No. of Lanes	2	2	1	2	2	0	0	3	1	0	2	1
Peak Hour Factor	1.00	1.00	1.00	1.00	1.00	1.00	1.00	1.00	1.00	1.00	1.00	1.00
Percent Heavy Veh, %	1	1	1	1	1	1	0	1	1	0	1	1
Cap, veh/h	226	988	305	1102	1792	151	0	1304	406	0	907	332
Arrive On Green	0.06	0.28	0.28	0.32	0.54	0.54	0.00	0.25	0.00	0.00	0.25	0.25
Sat Flow, veh/h	3476	3574	1104	3476	3300	277	0	5305	1599	0	3668	1308
Grp Volume(v), veh/h	162	790	25	173	158	161	0	874	0	0	386	45
Grp Sat Flow(s),veh/h/ln	1738	1787	1104	1738	1787	1790	0	1712	1599	0	1787	1308
Q Serve(g_s), s	5.0	22.6	1.8	3.9	4.9	5.0	0.0	16.8	0.0	0.0	9.9	2.9
Cycle Q Clear(g_c), s	5.0	22.6	1.8	3.9	4.9	5.0	0.0	16.8	0.0	0.0	9.9	2.9
Prop In Lane	1.00		1.00	1.00		0.15	0.00		1.00	0.00		1.00
Lane Grp Cap(c), veh/h	226	988	305	1102	970	972	0	1304	406	0	907	332
V/C Ratio(X)	0.72	0.80	0.08	0.16	0.16	0.17	0.00	0.67	0.00	0.00	0.43	0.14
Avail Cap(c_a), veh/h	348	988	305	1102	970	972	0	2446	762	0	1703	623
HCM Platoon Ratio	1.00	1.00	1.00	1.00	1.00	1.00	1.00	1.00	1.00	1.00	1.00	1.00
Upstream Filter(I)	1.00	1.00	1.00	1.00	1.00	1.00	0.00	1.00	0.00	0.00	1.00	1.00
Uniform Delay (d), s/veh	50.4	37.0	29.5	27.0	12.6	12.6	0.0	36.9	0.0	0.0	34.3	31.7
Incr Delay (d2), s/veh	4.2	6.8	0.5	0.1	0.4	0.4	0.0	0.6	0.0	0.0	0.3	0.2
Initial Q Delay(d3),s/veh	0.0	0.0	0.0	0.0	0.0	0.0	0.0	0.0	0.0	0.0	0.0	0.0
%ile BackOfQ(50%),veh/ln	2.5	12.0	0.6	1.9	2.5	2.6	0.0	8.0	0.0	0.0	4.9	1.1
LnGrp Delay(d),s/veh	54.7	43.7	30.0	27.1	13.0	13.0	0.0	37.5	0.0	0.0	34.6	31.9
LnGrp LOS	D	D	C	C	B	B		D			C	C
Approach Vol, veh/h		977			492			874			431	
Approach Delay, s/veh		45.2			17.9			37.5			34.4	
Approach LOS		D			B			D			C	
Timer	1	2	3	4	5	6	7	8				
Assigned Phs		2	3	4		6	7	8				
Phs Duration (G+Y+Rc), s		33.5	11.1	65.3		33.5	40.5	36.0				
Change Period (Y+Rc), s		5.6	4.0	5.6		5.6	5.6	* 5.6				
Max Green Setting (Gmax), s		52.4	11.0	31.4		52.4	12.0	* 30				
Max Q Clear Time (g_c+I1), s		18.8	7.0	7.0		11.9	5.9	24.6				
Green Ext Time (p_c), s		7.2	0.2	1.9		3.0	0.3	2.7				
Intersection Summary												
HCM 2010 Ctrl Delay			36.3									
HCM 2010 LOS			D									
Notes												



















10: Lakeshore Ave & Foothill Blvd
 HCM 2010 Signalized Intersection Summary

03/14/2019

								
Movement	WBL	WBR	NBT	NBR	SBL	SBT		
Lane Configurations	 		 			 		
Traffic Volume (veh/h)	111	83	1176	0	0	669		
Future Volume (veh/h)	111	83	1176	0	0	669		
Number	3	18	2	12	1	6		
Initial Q (Qb), veh	0	0	0	0	0	0		
Ped-Bike Adj(A_pbT)	1.00	1.00		1.00	1.00			
Parking Bus, Adj	1.00	1.00	1.00	1.00	1.00	1.00		
Adj Sat Flow, veh/h/ln	1863	1900	1863	0	0	1863		
Adj Flow Rate, veh/h	97	98	1176	0	0	669		
Adj No. of Lanes	1	1	2	0	0	2		
Peak Hour Factor	1.00	1.00	1.00	1.00	1.00	1.00		
Percent Heavy Veh, %	2	0	2	0	0	2		
Cap, veh/h	141	129	3032	0	0	3032		
Arrive On Green	0.08	0.08	0.86	0.00	0.00	0.86		
Sat Flow, veh/h	1774	1615	3725	0	0	3725		
Grp Volume(v), veh/h	97	98	1176	0	0	669		
Grp Sat Flow(s),veh/h/ln	1774	1615	1770	0	0	1770		
Q Serve(g_s), s	5.9	6.5	7.8	0.0	0.0	3.7		
Cycle Q Clear(g_c), s	5.9	6.5	7.8	0.0	0.0	3.7		
Prop In Lane	1.00	1.00		0.00	0.00			
Lane Grp Cap(c), veh/h	141	129	3032	0	0	3032		
V/C Ratio(X)	0.69	0.76	0.39	0.00	0.00	0.22		
Avail Cap(c_a), veh/h	411	374	3032	0	0	3032		
HCM Platoon Ratio	1.00	1.00	1.00	1.00	1.00	1.00		
Upstream Filter(I)	1.00	1.00	1.00	0.00	0.00	1.00		
Uniform Delay (d), s/veh	49.3	49.6	1.7	0.0	0.0	1.4		
Incr Delay (d2), s/veh	2.2	3.5	0.4	0.0	0.0	0.2		
Initial Q Delay(d3),s/veh	0.0	0.0	0.0	0.0	0.0	0.0		
%ile BackOfQ(50%),veh/ln	3.0	3.0	3.9	0.0	0.0	1.8		
LnGrp Delay(d),s/veh	51.5	53.0	2.1	0.0	0.0	1.6		
LnGrp LOS	D	D	A			A		
Approach Vol, veh/h	195		1176			669		
Approach Delay, s/veh	52.3		2.1			1.6		
Approach LOS	D		A			A		
Timer	1	2	3	4	5	6	7	8
Assigned Phs		2				6		8
Phs Duration (G+Y+Rc), s		97.7				97.7		12.3
Change Period (Y+Rc), s		3.5				3.5		3.5
Max Green Setting (Gmax), s		77.5				77.5		25.5
Max Q Clear Time (g_c+I1), s		9.8				5.7		8.5
Green Ext Time (p_c), s		8.0				3.7		0.3
Intersection Summary								
HCM 2010 Ctrl Delay			6.7					
HCM 2010 LOS			A					
Notes								





















11: Lakeshore Ave & MacArthur Blvd
 HCM 2010 Signalized Intersection Summary

03/14/2019

												
Movement	EBL	EBT	EBR	WBL	WBT	WBR	NBL	NBT	NBR	SBL	SBT	SBR
Lane Configurations												
Traffic Volume (veh/h)	209	1237	108	0	0	0	0	421	408	296	387	0
Future Volume (veh/h)	209	1237	108	0	0	0	0	421	408	296	387	0
Number	7	4	14				5	2	12	1	6	16
Initial Q (Qb), veh	0	0	0				0	0	0	0	0	0
Ped-Bike Adj(A_pbT)	1.00		0.94				1.00		0.93	1.00		1.00
Parking Bus, Adj	1.00	1.00	1.00				1.00	1.00	1.00	1.00	1.00	1.00
Adj Sat Flow, veh/h/ln	1881	1881	1881				0	1881	1900	1881	1881	0
Adj Flow Rate, veh/h	209	1237	29				0	421	408	296	387	0
Adj No. of Lanes	1	3	1				0	2	0	1	2	0
Peak Hour Factor	1.00	1.00	1.00				1.00	1.00	1.00	1.00	1.00	1.00
Percent Heavy Veh, %	1	1	1				0	1	1	1	1	0
Cap, veh/h	470	1481	395				0	674	563	426	2333	0
Arrive On Green	0.26	0.26	0.26				0.00	0.38	0.38	0.48	1.00	0.00
Sat Flow, veh/h	1792	5644	1505				0	1881	1491	1792	3668	0
Grp Volume(v), veh/h	209	1237	29				0	421	408	296	387	0
Grp Sat Flow(s),veh/h/ln	1792	1881	1505				0	1787	1491	1792	1787	0
Q Serve(g_s), s	10.3	21.9	1.5				0.0	20.3	24.9	13.7	0.0	0.0
Cycle Q Clear(g_c), s	10.3	21.9	1.5				0.0	20.3	24.9	13.7	0.0	0.0
Prop In Lane	1.00		1.00				0.00		1.00	1.00		0.00
Lane Grp Cap(c), veh/h	470	1481	395				0	674	563	426	2333	0
V/C Ratio(X)	0.44	0.84	0.07				0.00	0.62	0.73	0.70	0.17	0.00
Avail Cap(c_a), veh/h	490	1544	412				0	674	563	426	2333	0
HCM Platoon Ratio	1.00	1.00	1.00				1.00	1.00	1.00	2.00	2.00	1.00
Upstream Filter(I)	1.00	1.00	1.00				0.00	1.00	1.00	0.88	0.88	0.00
Uniform Delay (d), s/veh	32.6	36.9	29.4				0.0	26.9	28.3	24.8	0.0	0.0
Incr Delay (d2), s/veh	0.2	3.7	0.0				0.0	4.3	7.9	3.6	0.1	0.0
Initial Q Delay(d3),s/veh	0.0	0.0	0.0				0.0	0.0	0.0	0.0	0.0	0.0
%ile BackOfQ(50%),veh/ln	5.1	11.9	0.6				0.0	10.9	11.4	7.2	0.0	0.0
LnGrp Delay(d),s/veh	32.9	40.7	29.4				0.0	31.2	36.2	28.4	0.1	0.0
LnGrp LOS	C	D	C					C	D	C	A	
Approach Vol, veh/h		1475						829			683	
Approach Delay, s/veh		39.3						33.7			12.4	
Approach LOS		D						C			B	
Timer	1	2	3	4	5	6	7	8				
Assigned Phs	1	2		4		6						
Phs Duration (G+Y+Rc), s	29.2	44.0		32.8		73.2						
Change Period (Y+Rc), s	4.0	* 4		5.0		4.0						
Max Green Setting (Gmax), s	24.5	* 40		29.0		68.0						
Max Q Clear Time (g_c+I1), s	15.7	26.9		23.9		2.0						
Green Ext Time (p_c), s	0.3	3.5		2.9		2.0						
Intersection Summary												
HCM 2010 Ctrl Delay			31.6									
HCM 2010 LOS			C									
Notes												

12: Lakeshore Ave & Lake Park Ave
 HCM 2010 Signalized Intersection Summary

03/14/2019

												
Movement	EBL	EBT	EBR	WBL	WBT	WBR	NBL	NBT	NBR	SBL	SBT	SBR
Lane Configurations												
Traffic Volume (veh/h)	140	0	132	278	399	266	217	395	0	0	283	160
Future Volume (veh/h)	140	0	132	278	399	266	217	395	0	0	283	160
Number	7	4	14	3	8	18	5	2	12	1	6	16
Initial Q (Qb), veh	0	0	0	0	0	0	0	0	0	0	0	0
Ped-Bike Adj(A_pbT)	1.00		0.99	1.00		1.00	1.00		1.00	1.00		0.85
Parking Bus, Adj	1.00	1.00	1.00	1.00	1.00	1.00	1.00	1.00	1.00	1.00	1.00	1.00
Adj Sat Flow, veh/h/ln	1881	1881	1900	1900	1881	1881	1881	1881	0	0	1881	1900
Adj Flow Rate, veh/h	136	6	132	278	399	0	217	395	0	0	283	160
Adj No. of Lanes	1	1	0	0	2	1	2	1	0	0	2	0
Peak Hour Factor	1.00	1.00	1.00	1.00	1.00	1.00	1.00	1.00	1.00	1.00	1.00	1.00
Percent Heavy Veh, %	1	1	1	1	1	1	1	1	0	0	1	1
Cap, veh/h	188	7	160	473	472	422	553	920	0	0	608	324
Arrive On Green	0.11	0.11	0.11	0.26	0.26	0.00	0.32	0.98	0.00	0.00	0.29	0.29
Sat Flow, veh/h	1792	69	1519	1792	1787	1599	3476	1881	0	0	2206	1126
Grp Volume(v), veh/h	136	0	138	278	399	0	217	395	0	0	237	206
Grp Sat Flow(s),veh/h/ln	1792	0	1588	1792	1787	1599	1738	1881	0	0	1787	1451
Q Serve(g_s), s	7.8	0.0	9.0	14.3	22.4	0.0	5.2	0.8	0.0	0.0	11.5	12.5
Cycle Q Clear(g_c), s	7.8	0.0	9.0	14.3	22.4	0.0	5.2	0.8	0.0	0.0	11.5	12.5
Prop In Lane	1.00		0.96	1.00		1.00	1.00		0.00	0.00		0.78
Lane Grp Cap(c), veh/h	188	0	167	473	472	422	553	920	0	0	514	418
V/C Ratio(X)	0.72	0.00	0.83	0.59	0.85	0.00	0.39	0.43	0.00	0.00	0.46	0.49
Avail Cap(c_a), veh/h	211	0	187	473	472	422	553	920	0	0	514	418
HCM Platoon Ratio	1.00	1.00	1.00	1.00	1.00	1.00	2.00	2.00	1.00	1.00	1.00	1.00
Upstream Filter(I)	1.00	0.00	1.00	1.00	1.00	0.00	0.74	0.74	0.00	0.00	1.00	1.00
Uniform Delay (d), s/veh	45.9	0.0	46.5	34.0	36.9	0.0	32.2	0.6	0.0	0.0	31.0	31.3
Incr Delay (d2), s/veh	8.0	0.0	20.9	5.3	16.8	0.0	0.1	1.1	0.0	0.0	3.0	4.1
Initial Q Delay(d3),s/veh	0.0	0.0	0.0	0.0	0.0	0.0	0.0	0.0	0.0	0.0	0.0	0.0
%ile BackOfQ(50%),veh/ln	4.3	0.0	4.9	7.8	13.3	0.0	2.5	0.5	0.0	0.0	6.1	5.5
LnGrp Delay(d),s/veh	54.0	0.0	67.4	39.2	53.7	0.0	32.3	1.7	0.0	0.0	33.9	35.5
LnGrp LOS	D		E	D	D		C	A			C	D
Approach Vol, veh/h		274			677			612			443	
Approach Delay, s/veh		60.7			47.8			12.5			34.7	
Approach LOS		E			D			B			C	
Timer	1	2	3	4	5	6	7	8				
Assigned Phs		2		4	5	6		8				
Phs Duration (G+Y+Rc), s		56.4		16.6	21.4	35.0		33.0				
Change Period (Y+Rc), s		4.5		5.5	4.5	* 4.5		5.0				
Max Green Setting (Gmax), s		50.5		12.5	16.0	* 31		28.0				
Max Q Clear Time (g_c+I1), s		2.8		11.0	7.2	14.5		24.4				
Green Ext Time (p_c), s		1.8		0.1	0.3	1.8		1.1				
Intersection Summary												
HCM 2010 Ctrl Delay			35.9									
HCM 2010 LOS			D									
Notes												

Intersection	
Intersection Delay, s/veh	5
Intersection LOS	A




















Movement	EBL	EBT	WBT	WBR	SBL	SBR
Lane Configurations		↕	↔			
Traffic Vol, veh/h	728	752	332	102	0	0
Future Vol, veh/h	728	752	332	102	0	0
Peak Hour Factor	1.00	1.00	1.00	1.00	1.00	1.00
Heavy Vehicles, %	2	2	2	2	2	2
Mvmt Flow	728	752	332	102	0	0
Number of Lanes	0	1	1	0	0	0

Approach	EB	WB
Opposing Approach	WB	EB
Opposing Lanes	1	1
Conflicting Approach Left		
Conflicting Lanes Left	0	0
Conflicting Approach Right		
Conflicting Lanes Right	0	0
HCM Control Delay	5	5
HCM LOS	A	A

Lane	EBLn1	WBLn1
Vol Left, %	49%	0%
Vol Thru, %	51%	76%
Vol Right, %	0%	24%
Sign Control	Stop	Stop
Traffic Vol by Lane	1480	434
LT Vol	728	0
Through Vol	752	332
RT Vol	0	102
Lane Flow Rate	1480	434
Geometry Grp	0	0
Degree of Util (X)	0	0
Departure Headway (Hd)	0	0
Convergence, Y/N	Yes	Yes
Cap	0	0
Service Time	0	0
HCM Lane V/C Ratio	0	0
HCM Control Delay	5	5
HCM Lane LOS	N	N
HCM 95th-tile Q	0	0






















14: 5th Ave & E 8th St
 HCM 2010 Signalized Intersection Summary

03/14/2019

												
Movement	EBL	EBT	EBR	WBL	WBT	WBR	NBL	NBT	NBR	SBL	SBT	SBR
Lane Configurations												
Traffic Volume (veh/h)	156	832	369	41	214	2	56	301	48	42	488	61
Future Volume (veh/h)	156	832	369	41	214	2	56	301	48	42	488	61
Number	7	4	14	3	8	18	5	2	12	1	6	16
Initial Q (Qb), veh	0	0	0	0	0	0	0	0	0	0	0	0
Ped-Bike Adj(A_pbT)	0.99		0.96	1.00		0.97	1.00		0.98	1.00		0.98
Parking Bus, Adj	1.00	1.00	1.00	1.00	1.00	1.00	1.00	1.00	1.00	1.00	1.00	1.00
Adj Sat Flow, veh/h/ln	1863	1863	1863	1863	1863	1900	1900	1863	1900	1900	1863	1900
Adj Flow Rate, veh/h	156	832	210	41	214	2	56	301	48	42	488	61
Adj No. of Lanes	1	3	1	1	2	0	0	1	0	0	1	0
Peak Hour Factor	1.00	1.00	1.00	1.00	1.00	1.00	1.00	1.00	1.00	1.00	1.00	1.00
Percent Heavy Veh, %	2	2	2	2	2	2	2	2	2	2	2	2
Cap, veh/h	551	2141	642	274	1512	14	130	635	95	92	717	86
Arrive On Green	0.42	0.42	0.42	0.42	0.42	0.42	0.47	0.47	0.47	0.47	0.47	0.47
Sat Flow, veh/h	1153	5085	1525	538	3592	34	144	1341	200	72	1514	182
Grp Volume(v), veh/h	156	832	210	41	105	111	405	0	0	591	0	0
Grp Sat Flow(s),veh/h/ln	1153	1695	1525	538	1770	1856	1685	0	0	1768	0	0
Q Serve(g_s), s	6.4	7.5	6.2	3.8	2.4	2.4	0.0	0.0	0.0	3.9	0.0	0.0
Cycle Q Clear(g_c), s	8.9	7.5	6.2	11.3	2.4	2.4	10.0	0.0	0.0	17.1	0.0	0.0
Prop In Lane	1.00		1.00	1.00		0.02	0.14		0.12	0.07		0.10
Lane Grp Cap(c), veh/h	551	2141	642	274	745	781	860	0	0	895	0	0
V/C Ratio(X)	0.28	0.39	0.33	0.15	0.14	0.14	0.47	0.00	0.00	0.66	0.00	0.00
Avail Cap(c_a), veh/h	551	2141	642	274	745	781	860	0	0	895	0	0
HCM Platoon Ratio	1.00	1.00	1.00	1.00	1.00	1.00	1.00	1.00	1.00	1.00	1.00	1.00
Upstream Filter(I)	1.00	1.00	1.00	1.00	1.00	1.00	1.00	0.00	0.00	1.00	0.00	0.00
Uniform Delay (d), s/veh	14.6	13.3	12.9	17.2	11.8	11.9	11.8	0.0	0.0	13.6	0.0	0.0
Incr Delay (d2), s/veh	1.3	0.5	1.4	1.2	0.4	0.4	1.8	0.0	0.0	3.8	0.0	0.0
Initial Q Delay(d3),s/veh	0.0	0.0	0.0	0.0	0.0	0.0	0.0	0.0	0.0	0.0	0.0	0.0
%ile BackOfQ(50%),veh/ln	2.2	3.6	2.8	0.6	1.3	1.3	5.4	0.0	0.0	9.3	0.0	0.0
LnGrp Delay(d),s/veh	15.9	13.9	14.3	18.4	12.2	12.2	13.7	0.0	0.0	17.4	0.0	0.0
LnGrp LOS	B	B	B	B	B	B	B			B		
Approach Vol, veh/h		1198			257			405			591	
Approach Delay, s/veh		14.2			13.2			13.7			17.4	
Approach LOS		B			B			B			B	
Timer	1	2	3	4	5	6	7	8				
Assigned Phs		2		4		6		8				
Phs Duration (G+Y+Rc), s		35.0		31.5		35.0		31.5				
Change Period (Y+Rc), s		3.5		3.5		3.5		3.5				
Max Green Setting (Gmax), s		31.5		28.0		31.5		28.0				
Max Q Clear Time (g_c+I1), s		12.0		10.9		19.1		13.3				
Green Ext Time (p_c), s		2.7		5.2		3.3		1.3				
Intersection Summary												
HCM 2010 Ctrl Delay			14.8									
HCM 2010 LOS			B									

15: E 8th St/14th Ave & E 12th St
 HCM 2010 Signalized Intersection Summary

03/14/2019

												
Movement	EBL	EBT	EBR	WBL	WBT	WBR	NBL	NBT	NBR	SBL	SBT	SBR
Lane Configurations		 						 			  	
Traffic Volume (veh/h)	154	188	4	0	0	0	0	463	0	234	36	0
Future Volume (veh/h)	154	188	4	0	0	0	0	463	0	234	36	0
Number	1	6	16				7	4	14	3	8	18
Initial Q (Qb), veh	0	0	0				0	0	0	0	0	0
Ped-Bike Adj(A_pbT)	1.00		1.00				1.00		1.00	1.00		1.00
Parking Bus, Adj	1.00	1.00	1.00				1.00	1.00	1.00	1.00	1.00	1.00
Adj Sat Flow, veh/h/ln	1881	1881	1900				0	1881	0	1881	1881	0
Adj Flow Rate, veh/h	154	188	0				0	463	0	234	36	0
Adj No. of Lanes	1	2	0				0	2	0	1	3	0
Peak Hour Factor	1.00	1.00	1.00				1.00	1.00	1.00	1.00	1.00	1.00
Percent Heavy Veh, %	1	1	1				0	1	0	1	1	0
Cap, veh/h	524	1045	0				0	770	0	727	2844	0
Arrive On Green	0.29	0.29	0.00				0.00	0.22	0.00	0.29	0.55	0.00
Sat Flow, veh/h	1792	3668	0				0	3762	0	1792	5305	0
Grp Volume(v), veh/h	154	188	0				0	463	0	234	36	0
Grp Sat Flow(s),veh/h/ln	1792	1787	0				0	1787	0	1792	1712	0
Q Serve(g_s), s	4.3	2.6	0.0				0.0	7.6	0.0	4.5	0.2	0.0
Cycle Q Clear(g_c), s	4.3	2.6	0.0				0.0	7.6	0.0	4.5	0.2	0.0
Prop In Lane	1.00		0.00				0.00		0.00	1.00		0.00
Lane Grp Cap(c), veh/h	524	1045	0				0	770	0	727	2844	0
V/C Ratio(X)	0.29	0.18	0.00				0.00	0.60	0.00	0.32	0.01	0.00
Avail Cap(c_a), veh/h	524	1045	0				0	770	0	727	2844	0
HCM Platoon Ratio	1.00	1.00	1.00				1.00	1.00	1.00	1.00	1.00	1.00
Upstream Filter(I)	1.00	1.00	0.00				0.00	1.00	0.00	1.00	1.00	0.00
Uniform Delay (d), s/veh	17.8	17.2	0.0				0.0	23.0	0.0	8.9	6.5	0.0
Incr Delay (d2), s/veh	1.4	0.4	0.0				0.0	3.5	0.0	1.2	0.0	0.0
Initial Q Delay(d3),s/veh	0.0	0.0	0.0				0.0	0.0	0.0	0.0	0.0	0.0
%ile BackOfQ(50%),veh/ln	2.3	1.3	0.0				0.0	4.1	0.0	2.4	0.1	0.0
LnGrp Delay(d),s/veh	19.2	17.6	0.0				0.0	26.4	0.0	10.1	6.5	0.0
LnGrp LOS	B	B						C		B	A	
Approach Vol, veh/h		342						463			270	
Approach Delay, s/veh		18.3						26.4			9.6	
Approach LOS		B						C			A	
Timer	1	2	3	4	5	6	7	8				
Assigned Phs			3	4		6		8				
Phs Duration (G+Y+Rc), s			22.0	19.0		24.0		41.0				
Change Period (Y+Rc), s			3.0	5.0		5.0		5.0				
Max Green Setting (Gmax), s			19.0	14.0		19.0		36.0				
Max Q Clear Time (g_c+I1), s			6.5	9.6		6.3		2.2				
Green Ext Time (p_c), s			0.0	0.3		0.2		0.0				
Intersection Summary												
HCM 2010 Ctrl Delay			19.6									
HCM 2010 LOS			B									

16: Foothill & 14th Ave
 HCM Signalized Intersection Capacity Analysis

03/14/2019



Movement	EBL	EBT	EBR	WBL	WBT	WBR	NBL	NBT	NBR	SBL	SBT	SBR
Lane Configurations					↑↑						↑↑	
Traffic Volume (vph)	0	0	0	31	136	0	0	0	0	139	625	85
Future Volume (vph)	0	0	0	31	136	0	0	0	0	139	625	85
Ideal Flow (vphpl)	1900	1900	1900	1900	1900	1900	1900	1900	1900	1900	1900	1900
Total Lost time (s)					4.5						4.0	
Lane Util. Factor					0.95						0.95	
Frbp, ped/bikes					1.00						1.00	
Flpb, ped/bikes					1.00						1.00	
Frt					1.00						0.98	
Flt Protected					0.99						0.99	
Satd. Flow (prot)					3507						3448	
Flt Permitted					0.99						0.99	
Satd. Flow (perm)					3507						3448	
Peak-hour factor, PHF	1.00	1.00	1.00	1.00	1.00	1.00	1.00	1.00	1.00	1.00	1.00	1.00
Adj. Flow (vph)	0	0	0	31	136	0	0	0	0	139	625	85
RTOR Reduction (vph)	0	0	0	0	0	0	0	0	0	0	10	0
Lane Group Flow (vph)	0	0	0	0	167	0	0	0	0	0	839	0
Confl. Peds. (#/hr)	13		13			13	16		1			16
Confl. Bikes (#/hr)						10						2
Turn Type				Split	NA					Split	NA	
Protected Phases				5	5					6	6	
Permitted Phases												
Actuated Green, G (s)					8.4						35.8	
Effective Green, g (s)					8.4						35.8	
Actuated g/C Ratio					0.13						0.55	
Clearance Time (s)					4.5						4.0	
Vehicle Extension (s)					3.0						0.2	
Lane Grp Cap (vph)					453						1899	
v/s Ratio Prot					c0.05						c0.24	
v/s Ratio Perm												
v/c Ratio					0.37						0.44	
Uniform Delay, d1					25.9						8.7	
Progression Factor					1.86						1.00	
Incremental Delay, d2					0.5						0.7	
Delay (s)					48.5						9.4	
Level of Service					D						A	
Approach Delay (s)		0.0			48.5			0.0			9.4	
Approach LOS		A			D			A			A	
Intersection Summary												
HCM 2000 Control Delay			15.8		HCM 2000 Level of Service						B	
HCM 2000 Volume to Capacity ratio			0.37									
Actuated Cycle Length (s)			65.0		Sum of lost time (s)					14.0		
Intersection Capacity Utilization			43.0%		ICU Level of Service					A		
Analysis Period (min)			15									
c Critical Lane Group												

17: 14th Ave & Foothill Blvd
 HCM Signalized Intersection Capacity Analysis

03/14/2019



Movement	EBL	EBT	EBR	WBL	WBT	WBR	NBL	NBT	NBR	SBL	SBT	SBR
Lane Configurations		↕↕			↕↕			↕↕				
Traffic Volume (vph)	10	129	0	0	167	2	0	865	163	0	0	0
Future Volume (vph)	10	129	0	0	167	2	0	865	163	0	0	0
Ideal Flow (vphpl)	1900	1900	1900	1900	1900	1900	1900	1900	1900	1900	1900	1900
Total Lost time (s)		5.5			5.5			4.0				
Lane Util. Factor		0.95			0.95			0.95				
Frbp, ped/bikes		1.00			1.00			1.00				
Flpb, ped/bikes		1.00			1.00			1.00				
Frt		1.00			1.00			0.98				
Flt Protected		1.00			1.00			1.00				
Satd. Flow (prot)		3527			3531			3445				
Flt Permitted		0.94			1.00			1.00				
Satd. Flow (perm)		3312			3531			3445				
Peak-hour factor, PHF	1.00	1.00	1.00	1.00	1.00	1.00	1.00	1.00	1.00	1.00	1.00	1.00
Adj. Flow (vph)	10	129	0	0	167	2	0	865	163	0	0	0
RTOR Reduction (vph)	0	0	0	0	2	0	0	17	0	0	0	0
Lane Group Flow (vph)	0	139	0	0	167	0	0	1011	0	0	0	0
Confl. Peds. (#/hr)			5	5		10			3	3		
Confl. Bikes (#/hr)			1			10			8			
Turn Type	custom	NA			NA			NA				
Protected Phases	1	4 1			8			2				
Permitted Phases	4											
Actuated Green, G (s)		11.4			6.8			39.6				
Effective Green, g (s)		11.4			6.8			39.6				
Actuated g/C Ratio		0.18			0.10			0.61				
Clearance Time (s)					5.5			4.0				
Vehicle Extension (s)					0.2			0.2				
Lane Grp Cap (vph)		596			369			2098				
v/s Ratio Prot		c0.02			c0.05			c0.29				
v/s Ratio Perm		0.02										
v/c Ratio		0.23			0.45			0.48				
Uniform Delay, d1		23.0			27.4			7.0				
Progression Factor		1.73			1.00			1.00				
Incremental Delay, d2		0.1			0.3			0.8				
Delay (s)		39.8			27.7			7.8				
Level of Service		D			C			A				
Approach Delay (s)		39.8			27.7			7.8			0.0	
Approach LOS		D			C			A			A	
Intersection Summary												
HCM 2000 Control Delay			13.7									B
HCM 2000 Volume to Capacity ratio			0.46									
Actuated Cycle Length (s)			65.0								14.0	
Intersection Capacity Utilization			48.3%									A
Analysis Period (min)			15									

c Critical Lane Group

18: 23rd Ave & 16th St
 HCM Signalized Intersection Capacity Analysis

03/14/2019














Movement	WBL	WBR	NBT	NBR	SBL	SBT
Lane Configurations	W	R	T	R	L	R
Traffic Volume (vph)	22	42	313	22	24	287
Future Volume (vph)	22	42	313	22	24	287
Ideal Flow (vphpl)	1900	1900	1900	1900	1900	1900
Total Lost time (s)	4.5		4.0			4.0
Lane Util. Factor	1.00		1.00			1.00
Frbp, ped/bikes	0.97		0.99			1.00
Flpb, ped/bikes	1.00		1.00			1.00
Frt	0.91		0.99			1.00
Flt Protected	0.98		1.00			1.00
Satd. Flow (prot)	1626		1832			1848
Flt Permitted	0.98		1.00			0.96
Satd. Flow (perm)	1626		1832			1784
Peak-hour factor, PHF	1.00	1.00	1.00	1.00	1.00	1.00
Adj. Flow (vph)	22	42	313	22	24	287
RTOR Reduction (vph)	36	0	3	0	0	0
Lane Group Flow (vph)	28	0	332	0	0	311
Confl. Peds. (#/hr)		3		62	62	
Confl. Bikes (#/hr)		3		7		
Turn Type	Prot		NA		Perm	NA
Protected Phases	7		2			2
Permitted Phases					2	
Actuated Green, G (s)	7.6		21.3			21.3
Effective Green, g (s)	7.6		21.3			21.3
Actuated g/C Ratio	0.13		0.38			0.38
Clearance Time (s)	4.5		4.0			4.0
Vehicle Extension (s)	3.0		3.0			3.0
Lane Grp Cap (vph)	219		693			674
v/s Ratio Prot	c0.02		c0.18			
v/s Ratio Perm						0.17
v/c Ratio	0.13		0.48			0.46
Uniform Delay, d1	21.4		13.3			13.2
Progression Factor	1.00		1.00			0.24
Incremental Delay, d2	0.3		0.5			0.5
Delay (s)	21.7		13.8			3.6
Level of Service	C		B			A
Approach Delay (s)	21.7		13.8			3.6
Approach LOS	C		B			A
Intersection Summary						
HCM 2000 Control Delay			10.0		HCM 2000 Level of Service	B
HCM 2000 Volume to Capacity ratio			0.25			
Actuated Cycle Length (s)			56.3		Sum of lost time (s)	12.5
Intersection Capacity Utilization			46.2%		ICU Level of Service	A
Analysis Period (min)			15			
c Critical Lane Group						

HCM 2010 Signalized Intersection Summary

1: Embarcadero W & Oak St

05/05/2020

								
Movement	EBL	EBR	NBL	NBT	SBT	SBR		
Lane Configurations								
Traffic Volume (veh/h)	79	77	253	666	210	21		
Future Volume (veh/h)	79	77	253	666	210	21		
Number	7	14	5	2	6	16		
Initial Q (Qb), veh	0	0	0	0	0	0		
Ped-Bike Adj(A_pbT)	1.00	1.00	0.98			0.95		
Parking Bus, Adj	1.00	1.00	1.00	1.00	1.00	1.00		
Adj Sat Flow, veh/h/ln	1583	1583	1583	1583	1583	1710		
Adj Flow Rate, veh/h	79	77	253	666	210	21		
Adj No. of Lanes	1	1	1	1	1	0		
Peak Hour Factor	1.00	1.00	1.00	1.00	1.00	1.00		
Percent Heavy Veh, %	8	8	8	8	8	8		
Cap, veh/h	141	126	789	1128	1004	100		
Arrive On Green	0.09	0.09	0.71	0.71	0.71	0.71		
Sat Flow, veh/h	1508	1346	958	1583	1410	141		
Grp Volume(v), veh/h	79	77	253	666	0	231		
Grp Sat Flow(s),veh/h/ln	1508	1346	958	1583	0	1551		
Q Serve(g_s), s	2.3	2.5	5.6	9.7	0.0	2.3		
Cycle Q Clear(g_c), s	2.3	2.5	8.0	9.7	0.0	2.3		
Prop In Lane	1.00	1.00	1.00			0.09		
Lane Grp Cap(c), veh/h	141	126	789	1128	0	1105		
V/C Ratio(X)	0.56	0.61	0.32	0.59	0.00	0.21		
Avail Cap(c_a), veh/h	586	523	789	1128	0	1105		
HCM Platoon Ratio	1.00	1.00	1.00	1.00	1.00	1.00		
Upstream Filter(I)	1.00	1.00	1.00	1.00	0.00	1.00		
Uniform Delay (d), s/veh	20.1	20.2	3.6	3.3	0.0	2.3		
Incr Delay (d2), s/veh	3.5	4.8	1.1	2.3	0.0	0.4		
Initial Q Delay(d3),s/veh	0.0	0.0	0.0	0.0	0.0	0.0		
%ile BackOfQ(50%),veh/ln	1.1	1.1	1.6	4.8	0.0	1.1		
LnGrp Delay(d),s/veh	23.6	24.9	4.7	5.6	0.0	2.7		
LnGrp LOS	C	C	A	A		A		
Approach Vol, veh/h	156			919	231			
Approach Delay, s/veh	24.2			5.3	2.7			
Approach LOS	C			A	A			
Timer	1	2	3	4	5	6	7	8
Assigned Phs		2		4		6		
Phs Duration (G+Y+Rc), s		37.5		8.8		37.5		
Change Period (Y+Rc), s		4.5		4.5		4.5		
Max Green Setting (Gmax), s		33.0		18.0		33.0		
Max Q Clear Time (g_c+I1), s		11.7		4.5		4.3		
Green Ext Time (p_c), s		6.3		0.3		1.4		
Intersection Summary								
HCM 2010 Ctrl Delay			7.1					
HCM 2010 LOS			A					

2: Broadway & 5th Street HCM Signalized Intersection Capacity Analysis

03/14/2019



Movement	EBL	EBT	EBR	EBR2	NBT	NBR	NBR2	SBL2	SBL	SBT
Lane Configurations		↕↕	↗	↗	↕↕	↘			↘	↕↕
Traffic Volume (vph)	16	146	713	50	238	55	170	204	114	218
Future Volume (vph)	16	146	713	50	238	55	170	204	114	218
Ideal Flow (vphpl)	1900	1900	1900	1900	1900	1900	1900	1900	1900	1900
Total Lost time (s)		5.5	5.5	5.5	4.5	4.5			4.5	4.5
Lane Util. Factor		0.91	0.91	1.00	0.95	1.00			0.91	0.91
Frbp, ped/bikes		1.00	1.00	0.98	1.00	0.88			1.00	1.00
Flpb, ped/bikes		1.00	1.00	1.00	1.00	1.00			1.00	0.99
Frt		0.90	0.85	0.85	1.00	0.85			1.00	1.00
Flt Protected		1.00	1.00	1.00	1.00	1.00			0.95	0.98
Satd. Flow (prot)		2580	1225	1321	3008	1186			1369	2805
Flt Permitted		1.00	1.00	1.00	1.00	1.00			0.95	0.84
Satd. Flow (perm)		2580	1225	1321	3008	1186			1369	2379
Peak-hour factor, PHF	1.00	1.00	1.00	1.00	1.00	1.00	1.00	1.00	1.00	1.00
Adj. Flow (vph)	16	146	713	50	238	55	170	204	114	218
RTOR Reduction (vph)	0	0	0	35	0	144	0	0	0	0
Lane Group Flow (vph)	0	519	356	15	238	81	0	0	215	321
Confl. Peds. (#/hr)				5		55			55	
Confl. Bikes (#/hr)						1				
Heavy Vehicles (%)	8%	8%	8%	8%	8%	8%	8%	8%	8%	8%
Turn Type	Perm	NA	Prot	Perm	NA	Perm		Prot	Prot	NA
Protected Phases		4	4		2			1	1	6
Permitted Phases	4			4		2				
Actuated Green, G (s)		22.5	22.5	22.5	11.5	11.5			26.5	42.5
Effective Green, g (s)		22.5	22.5	22.5	11.5	11.5			26.5	42.5
Actuated g/C Ratio		0.30	0.30	0.30	0.15	0.15			0.35	0.57
Clearance Time (s)		5.5	5.5	5.5	4.5	4.5			4.5	4.5
Vehicle Extension (s)		2.0	2.0	2.0	2.0	2.0			2.0	2.0
Lane Grp Cap (vph)		774	367	396	461	181			483	1498
v/s Ratio Prot			c0.29		c0.08				c0.16	0.08
v/s Ratio Perm		0.20		0.01		0.07				0.05
v/c Ratio		0.93dr	0.97	0.04	0.52	0.45			0.45	0.21
Uniform Delay, d1		23.0	25.9	18.6	29.2	28.9			18.6	8.0
Progression Factor		1.00	1.00	1.00	1.00	1.00			1.00	1.00
Incremental Delay, d2		1.8	38.8	0.0	0.4	0.6			3.0	0.3
Delay (s)		24.8	64.7	18.6	29.6	29.5			21.6	8.3
Level of Service		C	E	B	C	C			C	A
Approach Delay (s)		39.8			29.6					13.6
Approach LOS		D			C					B

Intersection Summary

HCM 2000 Control Delay	30.1	HCM 2000 Level of Service	C
HCM 2000 Volume to Capacity ratio	0.65		
Actuated Cycle Length (s)	75.0	Sum of lost time (s)	14.5
Intersection Capacity Utilization	82.0%	ICU Level of Service	E
Analysis Period (min)	15		

dr Defacto Right Lane. Recode with 1 though lane as a right lane.

c Critical Lane Group

3: 6th Street & Jackson St
 HCM Signalized Intersection Capacity Analysis
























03/14/2019



Movement	WBL	WBT	WBR2	NBL2	NBT	SBT	SBR	SER2
Lane Configurations	↶	↑	↷	↶	↑	↷		↷
Traffic Volume (vph)	15	527	112	171	415	139	399	1066
Future Volume (vph)	15	527	112	171	415	139	399	1066
Ideal Flow (vphpl)	1900	1900	1900	1900	1900	1900	1900	1900
Total Lost time (s)	5.5	5.5	5.5	5.5	5.5	5.5		5.5
Lane Util. Factor	1.00	1.00	1.00	1.00	1.00	1.00		1.00
Frpb, ped/bikes	1.00	1.00	0.98	1.00	1.00	0.98		1.00
Flpb, ped/bikes	0.99	1.00	1.00	1.00	1.00	1.00		1.00
Frt	1.00	1.00	0.85	1.00	1.00	0.90		0.86
Flt Protected	0.95	1.00	1.00	0.95	1.00	1.00		1.00
Satd. Flow (prot)	1566	1660	1383	1573	1660	1459		1450
Flt Permitted	0.95	1.00	1.00	0.33	1.00	1.00		1.00
Satd. Flow (perm)	1566	1660	1383	544	1660	1459		1450
Peak-hour factor, PHF	1.00	1.00	1.00	1.00	1.00	1.00	1.00	0.92
Adj. Flow (vph)	15	527	112	171	415	139	399	1159
RTOR Reduction (vph)	0	0	72	0	0	0	0	0
Lane Group Flow (vph)	15	527	40	171	415	538	0	1159
Confl. Peds. (#/hr)	3		5	6				6
Confl. Bikes (#/hr)			1					7
Heavy Vehicles (%)	3%	3%	3%	3%	3%	3%	3%	2%
Turn Type	Perm	NA	Perm	Perm	NA	NA		Perm
Protected Phases		8			2	6		
Permitted Phases	8		8	2				6 8
Actuated Green, G (s)	25.5	25.5	25.5	34.5	34.5	34.5		71.0
Effective Green, g (s)	25.5	25.5	25.5	34.5	34.5	34.5		71.0
Actuated g/C Ratio	0.36	0.36	0.36	0.49	0.49	0.49		1.00
Clearance Time (s)	5.5	5.5	5.5	5.5	5.5	5.5		
Vehicle Extension (s)	3.0	3.0	3.0	3.0	3.0	3.0		
Lane Grp Cap (vph)	562	596	496	264	806	708		1450
v/s Ratio Prot		0.32			0.25	0.37		
v/s Ratio Perm	0.01		0.03	0.31				c0.80
v/c Ratio	0.03	0.88	0.08	0.65	0.51	0.76		0.80
Uniform Delay, d1	14.7	21.4	15.0	13.7	12.5	14.9		0.0
Progression Factor	1.00	1.00	1.00	1.00	1.00	1.00		1.00
Incremental Delay, d2	0.0	14.6	0.1	11.7	2.3	7.5		3.2
Delay (s)	14.7	35.9	15.1	25.4	14.9	22.4		3.2
Level of Service	B	D	B	C	B	C		A
Approach Delay (s)		31.9			17.9	22.4		
Approach LOS		C			B	C		
Intersection Summary								
HCM 2000 Control Delay			16.0		HCM 2000 Level of Service			B
HCM 2000 Volume to Capacity ratio			0.95					
Actuated Cycle Length (s)			71.0		Sum of lost time (s)			11.0
Intersection Capacity Utilization			168.9%		ICU Level of Service			H
Analysis Period (min)			15					
c Critical Lane Group								





















4: 5th Ave & Embarcadero W
 HCM 2010 Signalized Intersection Summary

03/14/2019

												
Movement	EBL	EBT	EBR	WBL	WBT	WBR	NBL	NBT	NBR	SBL	SBT	SBR
Lane Configurations		 			 					 		
Traffic Volume (veh/h)	49	307	14	20	730	474	66	53	54	465	12	16
Future Volume (veh/h)	49	307	14	20	730	474	66	53	54	465	12	16
Number	7	4	14	3	8	18	5	2	12	1	6	16
Initial Q (Qb), veh	0	0	0	0	0	0	0	0	0	0	0	0
Ped-Bike Adj(A_pbT)	1.00		1.00	1.00		0.98	1.00		0.99	1.00		0.99
Parking Bus, Adj	1.00	1.00	1.00	1.00	1.00	1.00	1.00	1.00	1.00	1.00	1.00	1.00
Adj Sat Flow, veh/h/ln	1845	1845	1900	1845	1845	1900	1845	1845	1900	1845	1845	1900
Adj Flow Rate, veh/h	49	307	14	20	730	474	66	53	54	465	12	4
Adj No. of Lanes	1	2	0	1	2	0	1	1	0	2	1	0
Peak Hour Factor	1.00	1.00	1.00	1.00	1.00	1.00	1.00	1.00	1.00	1.00	1.00	1.00
Percent Heavy Veh, %	3	3	3	3	3	3	3	3	3	3	3	3
Cap, veh/h	351	2020	92	696	1199	773	165	78	80	561	218	73
Arrive On Green	1.00	1.00	1.00	1.00	1.00	1.00	0.09	0.09	0.09	0.16	0.16	0.16
Sat Flow, veh/h	458	3414	155	1041	2027	1307	1757	833	849	3408	1322	441
Grp Volume(v), veh/h	49	157	164	20	630	574	66	0	107	465	0	16
Grp Sat Flow(s),veh/h/ln	458	1752	1817	1041	1752	1582	1757	0	1682	1704	0	1763
Q Serve(g_s), s	0.0	0.0	0.0	0.0	0.0	0.0	3.2	0.0	5.5	11.9	0.0	0.7
Cycle Q Clear(g_c), s	0.0	0.0	0.0	0.0	0.0	0.0	3.2	0.0	5.5	11.9	0.0	0.7
Prop In Lane	1.00		0.09	1.00		0.83	1.00		0.50	1.00		0.25
Lane Grp Cap(c), veh/h	351	1037	1075	696	1037	936	165	0	158	561	0	290
V/C Ratio(X)	0.14	0.15	0.15	0.03	0.61	0.61	0.40	0.00	0.68	0.83	0.00	0.06
Avail Cap(c_a), veh/h	351	1037	1075	696	1037	936	351	0	336	685	0	355
HCM Platoon Ratio	2.00	2.00	2.00	2.00	2.00	2.00	1.00	1.00	1.00	1.00	1.00	1.00
Upstream Filter(I)	0.94	0.94	0.94	0.81	0.81	0.81	1.00	0.00	1.00	1.00	0.00	1.00
Uniform Delay (d), s/veh	0.0	0.0	0.0	0.0	0.0	0.0	38.4	0.0	39.5	36.4	0.0	31.7
Incr Delay (d2), s/veh	0.8	0.3	0.3	0.1	2.2	2.4	1.6	0.0	5.0	7.0	0.0	0.1
Initial Q Delay(d3),s/veh	0.0	0.0	0.0	0.0	0.0	0.0	0.0	0.0	0.0	0.0	0.0	0.0
%ile BackOfQ(50%),veh/ln	0.1	0.1	0.1	0.0	0.6	0.6	1.6	0.0	2.8	6.1	0.0	0.3
LnGrp Delay(d),s/veh	0.8	0.3	0.3	0.1	2.2	2.4	40.0	0.0	44.5	43.4	0.0	31.8
LnGrp LOS	A	A	A	A	A	A	D		D	D		C
Approach Vol, veh/h		370			1224			173				481
Approach Delay, s/veh		0.4			2.3			42.8				43.0
Approach LOS		A			A			D				D
Timer	1	2	3	4	5	6	7	8				
Assigned Phs		2		4		6		8				
Phs Duration (G+Y+Rc), s		12.9		57.7		19.3		57.7				
Change Period (Y+Rc), s		4.5		4.5		4.5		4.5				
Max Green Setting (Gmax), s		18.0		40.4		18.1		40.4				
Max Q Clear Time (g_c+I1), s		7.5		2.0		13.9		2.0				
Green Ext Time (p_c), s		0.5		2.8		0.8		11.5				
Intersection Summary												
HCM 2010 Ctrl Delay				13.8								
HCM 2010 LOS				B								























5: 6th Ave/880 Off-Ramp & Embarcadero W
 HCM 2010 Signalized Intersection Summary

03/14/2019

												
Movement	EBL	EBT	EBR	WBL	WBT	WBR	NBL	NBT	NBR	SBL	SBT	SBR
Lane Configurations												
Traffic Volume (veh/h)	0	744	65	13	650	0	270	0	128	98	25	289
Future Volume (veh/h)	0	744	65	13	650	0	270	0	128	98	25	289
Number	7	4	14	3	8	18	5	2	12	1	6	16
Initial Q (Qb), veh	0	0	0	0	0	0	0	0	0	0	0	0
Ped-Bike Adj(A_pbT)	1.00		0.84	0.96		1.00	1.00		1.00	1.00		1.00
Parking Bus, Adj	1.00	1.00	1.00	1.00	1.00	1.00	1.00	1.00	1.00	1.00	1.00	1.00
Adj Sat Flow, veh/h/ln	0	1830	1900	1863	1827	0	1863	0	1863	1827	1863	1827
Adj Flow Rate, veh/h	0	744	65	13	650	0	270	0	26	98	25	142
Adj No. of Lanes	0	2	0	1	2	0	1	0	1	1	1	1
Peak Hour Factor	1.00	1.00	1.00	1.00	1.00	1.00	1.00	1.00	1.00	1.00	1.00	1.00
Percent Heavy Veh, %	0	4	4	2	4	0	2	0	2	4	2	4
Cap, veh/h	0	2487	217	582	2715	0	0	0	0	205	220	183
Arrive On Green	0.00	1.00	1.00	1.00	1.00	0.00	0.00	0.00	0.00	0.12	0.12	0.12
Sat Flow, veh/h	0	3272	278	641	3563	0		0		1740	1863	1553
Grp Volume(v), veh/h	0	406	403	13	650	0		0.0		98	25	142
Grp Sat Flow(s),veh/h/ln	0	1738	1719	641	1736	0				1740	1863	1553
Q Serve(g_s), s	0.0	0.0	0.0	0.0	0.0	0.0				4.7	1.1	8.0
Cycle Q Clear(g_c), s	0.0	0.0	0.0	0.0	0.0	0.0				4.7	1.1	8.0
Prop In Lane	0.00		0.16	1.00		0.00				1.00		1.00
Lane Grp Cap(c), veh/h	0	1359	1345	582	2715	0				205	220	183
V/C Ratio(X)	0.00	0.30	0.30	0.02	0.24	0.00				0.48	0.11	0.78
Avail Cap(c_a), veh/h	0	1359	1345	582	2715	0				396	424	354
HCM Platoon Ratio	1.00	2.00	2.00	2.00	2.00	1.00				1.00	1.00	1.00
Upstream Filter(I)	0.00	0.88	0.88	0.98	0.98	0.00				1.00	1.00	1.00
Uniform Delay (d), s/veh	0.0	0.0	0.0	0.0	0.0	0.0				37.1	35.5	38.5
Incr Delay (d2), s/veh	0.0	0.5	0.5	0.1	0.2	0.0				1.7	0.2	6.9
Initial Q Delay(d3),s/veh	0.0	0.0	0.0	0.0	0.0	0.0				0.0	0.0	0.0
%ile BackOfQ(50%),veh/ln	0.0	0.2	0.2	0.0	0.1	0.0				2.4	0.6	3.8
LnGrp Delay(d),s/veh	0.0	0.5	0.5	0.1	0.2	0.0				38.8	35.7	45.4
LnGrp LOS		A	A	A	A					D	D	D
Approach Vol, veh/h		809			663						265	
Approach Delay, s/veh		0.5			0.2						42.0	
Approach LOS		A			A						D	
Timer	1	2	3	4	5	6	7	8				
Assigned Phs				4		6		8				
Phs Duration (G+Y+Rc), s				74.9		15.1		74.9				
Change Period (Y+Rc), s				4.5		4.5		4.5				
Max Green Setting (Gmax), s				33.5		20.5		33.5				
Max Q Clear Time (g_c+11), s				2.0		10.0		2.0				
Green Ext Time (p_c), s				5.9		0.6		5.2				
Intersection Summary												
HCM 2010 Ctrl Delay			6.7									
HCM 2010 LOS			A									

















6: Webster St & Atlantic Ave
 HCM 2010 Signalized Intersection Summary

03/14/2019

												
Movement	EBL	EBT	EBR	WBL	WBT	WBR	NBL	NBT	NBR	SBL	SBT	SBR
Lane Configurations												
Traffic Volume (veh/h)	177	305	146	23	374	46	140	539	66	90	370	349
Future Volume (veh/h)	177	305	146	23	374	46	140	539	66	90	370	349
Number	7	4	14	3	8	18	5	2	12	1	6	16
Initial Q (Qb), veh	0	0	0	0	0	0	0	0	0	0	0	0
Ped-Bike Adj(A_pbT)	1.00		0.96	1.00		0.92	1.00		0.96	1.00		0.95
Parking Bus, Adj	1.00	1.00	1.00	1.00	1.00	1.00	1.00	1.00	1.00	1.00	1.00	1.00
Adj Sat Flow, veh/h/ln	1827	1827	1827	1827	1827	1900	1827	1827	1900	1827	1827	1827
Adj Flow Rate, veh/h	192	332	21	25	407	50	152	586	72	98	402	88
Adj No. of Lanes	2	2	1	1	2	0	2	2	0	1	2	1
Peak Hour Factor	0.92	0.92	0.92	0.92	0.92	0.92	0.92	0.92	0.92	0.92	0.92	0.92
Percent Heavy Veh, %	4	4	4	4	4	4	4	4	4	4	4	4
Cap, veh/h	640	658	282	415	735	90	233	874	107	126	992	422
Arrive On Green	0.19	0.19	0.19	0.24	0.24	0.24	0.07	0.28	0.28	0.07	0.29	0.29
Sat Flow, veh/h	3375	3471	1489	1740	3081	375	3375	3095	379	1740	3471	1477
Grp Volume(v), veh/h	192	332	21	25	228	229	152	328	330	98	402	88
Grp Sat Flow(s),veh/h/ln	1688	1736	1489	1740	1736	1720	1688	1736	1739	1740	1736	1477
Q Serve(g_s), s	3.8	6.7	0.9	0.9	9.0	9.2	3.4	13.1	13.2	4.3	7.3	3.5
Cycle Q Clear(g_c), s	3.8	6.7	0.9	0.9	9.0	9.2	3.4	13.1	13.2	4.3	7.3	3.5
Prop In Lane	1.00		1.00	1.00		0.22	1.00		0.22	1.00		1.00
Lane Grp Cap(c), veh/h	640	658	282	415	414	411	233	490	491	126	992	422
V/C Ratio(X)	0.30	0.50	0.07	0.06	0.55	0.56	0.65	0.67	0.67	0.78	0.41	0.21
Avail Cap(c_a), veh/h	1076	1107	475	555	553	548	431	730	732	288	1594	678
HCM Platoon Ratio	1.00	1.00	1.00	1.00	1.00	1.00	1.00	1.00	1.00	1.00	1.00	1.00
Upstream Filter(I)	1.00	1.00	1.00	1.00	1.00	1.00	1.00	1.00	1.00	1.00	1.00	1.00
Uniform Delay (d), s/veh	27.3	28.5	26.1	23.1	26.1	26.2	35.6	24.9	24.9	35.7	22.6	21.3
Incr Delay (d2), s/veh	0.3	0.6	0.1	0.1	1.1	1.2	3.1	1.6	1.6	9.8	0.3	0.2
Initial Q Delay(d3),s/veh	0.0	0.0	0.0	0.0	0.0	0.0	0.0	0.0	0.0	0.0	0.0	0.0
%ile BackOfQ(50%),veh/ln	1.8	3.3	0.4	0.4	4.4	4.5	1.7	6.5	6.5	2.4	3.6	1.5
LnGrp Delay(d),s/veh	27.6	29.1	26.2	23.1	27.3	27.4	38.6	26.5	26.5	45.5	22.9	21.5
LnGrp LOS	C	C	C	C	C	C	D	C	C	D	C	C
Approach Vol, veh/h		545			482			810			588	
Approach Delay, s/veh		28.4			27.1			28.8			26.5	
Approach LOS		C			C			C			C	
Timer	1	2	3	4	5	6	7	8				
Assigned Phs	1	2		4	5	6		8				
Phs Duration (G+Y+Rc), s	9.7	27.1		18.9	9.4	27.4		22.7				
Change Period (Y+Rc), s	4.0	5.0		4.0	4.0	5.0		4.0				
Max Green Setting (Gmax), s	13.0	33.0		25.0	10.0	36.0		25.0				
Max Q Clear Time (g_c+I1), s	6.3	15.2		8.7	5.4	9.3		11.2				
Green Ext Time (p_c), s	0.1	4.1		2.8	0.2	3.3		2.5				
Intersection Summary												
HCM 2010 Ctrl Delay				27.8								
HCM 2010 LOS				C								

















7: Broadway & Embarcadero W
 HCM 2010 Signalized Intersection Summary

03/14/2019

												
Movement	EBL	EBT	EBR	WBL	WBT	WBR	NBL	NBT	NBR	SBL	SBT	SBR
Lane Configurations												
Traffic Volume (veh/h)	9	29	6	96	71	169	2	9	27	61	19	7
Future Volume (veh/h)	9	29	6	96	71	169	2	9	27	61	19	7
Number	7	4	14	3	8	18	5	2	12	1	6	16
Initial Q (Qb), veh	0	0	0	0	0	0	0	0	0	0	0	0
Ped-Bike Adj(A_pbT)	1.00		0.98	0.99		0.97	0.96		0.94	0.96		0.93
Parking Bus, Adj	1.00	1.00	1.00	1.00	1.00	1.00	1.00	1.00	1.00	1.00	1.00	1.00
Adj Sat Flow, veh/h/ln	1710	1487	1710	1710	1487	1710	1710	1487	1710	1710	1487	1710
Adj Flow Rate, veh/h	9	29	6	96	71	169	2	9	27	61	19	7
Adj No. of Lanes	0	1	0	0	1	0	0	1	0	0	2	0
Peak Hour Factor	1.00	1.00	1.00	1.00	1.00	1.00	1.00	1.00	1.00	1.00	1.00	1.00
Percent Heavy Veh, %	15	15	15	15	15	15	15	15	15	15	15	15
Cap, veh/h	168	453	86	215	157	292	75	129	332	528	344	127
Arrive On Green	0.46	0.46	0.46	0.46	0.46	0.46	0.37	0.37	0.37	0.37	0.37	0.37
Sat Flow, veh/h	191	977	184	283	339	629	16	347	891	1066	923	340
Grp Volume(v), veh/h	44	0	0	336	0	0	38	0	0	61	0	26
Grp Sat Flow(s),veh/h/ln	1353	0	0	1250	0	0	1254	0	0	1066	0	1264
Q Serve(g_s), s	0.0	0.0	0.0	5.5	0.0	0.0	0.0	0.0	0.0	0.7	0.0	0.7
Cycle Q Clear(g_c), s	0.9	0.0	0.0	10.5	0.0	0.0	1.1	0.0	0.0	1.8	0.0	0.7
Prop In Lane	0.20		0.14	0.29		0.50	0.05		0.71	1.00		0.27
Lane Grp Cap(c), veh/h	706	0	0	664	0	0	536	0	0	528	0	471
V/C Ratio(X)	0.06	0.00	0.00	0.51	0.00	0.00	0.07	0.00	0.00	0.12	0.00	0.06
Avail Cap(c_a), veh/h	706	0	0	664	0	0	536	0	0	528	0	471
HCM Platoon Ratio	1.00	1.00	1.00	1.00	1.00	1.00	1.00	1.00	1.00	1.00	1.00	1.00
Upstream Filter(I)	1.00	0.00	0.00	1.00	0.00	0.00	1.00	0.00	0.00	1.00	0.00	1.00
Uniform Delay (d), s/veh	8.2	0.0	0.0	10.6	0.0	0.0	11.2	0.0	0.0	11.3	0.0	11.0
Incr Delay (d2), s/veh	0.2	0.0	0.0	2.7	0.0	0.0	0.3	0.0	0.0	0.4	0.0	0.2
Initial Q Delay(d3),s/veh	0.0	0.0	0.0	0.0	0.0	0.0	0.0	0.0	0.0	0.0	0.0	0.0
%ile BackOfQ(50%),veh/ln	0.4	0.0	0.0	4.1	0.0	0.0	0.4	0.0	0.0	0.7	0.0	0.3
LnGrp Delay(d),s/veh	8.3	0.0	0.0	13.4	0.0	0.0	11.4	0.0	0.0	11.8	0.0	11.3
LnGrp LOS	A			B			B			B		B
Approach Vol, veh/h		44			336			38				87
Approach Delay, s/veh		8.3			13.4			11.4				11.6
Approach LOS		A			B			B				B
Timer	1	2	3	4	5	6	7	8				
Assigned Phs		2		4		6		8				
Phs Duration (G+Y+Rc), s		25.0		30.0		25.0		30.0				
Change Period (Y+Rc), s		4.5		4.5		4.5		4.5				
Max Green Setting (Gmax), s		20.5		25.5		20.5		25.5				
Max Q Clear Time (g_c+I1), s		3.1		2.9		3.8		12.5				
Green Ext Time (p_c), s		0.1		0.2		0.3		1.8				
Intersection Summary												
HCM 2010 Ctrl Delay				12.5								
HCM 2010 LOS				B								






















8: Oak St & 5th Street
 HCM 2010 Signalized Intersection Summary

03/14/2019

												
Movement	EBL	EBT	EBR	WBL	WBT	WBR	NBL	NBT	NBR	SBL	SBT	SBR
Lane Configurations												
Traffic Volume (veh/h)	291	485	188	0	0	0	0	376	61	2	47	0
Future Volume (veh/h)	291	485	188	0	0	0	0	376	61	2	47	0
Number	7	4	14				5	2	12	1	6	16
Initial Q (Qb), veh	0	0	0				0	0	0	0	0	0
Ped-Bike Adj(A_pbT)	1.00		0.99				1.00		0.97	1.00		1.00
Parking Bus, Adj	1.00	1.00	1.00				1.00	1.00	1.00	1.00	1.00	1.00
Adj Sat Flow, veh/h/ln	1629	1629	1710				0	1629	1710	1710	1629	0
Adj Flow Rate, veh/h	291	485	188				0	376	61	2	47	0
Adj No. of Lanes	1	2	0				0	1	0	0	1	0
Peak Hour Factor	1.00	1.00	1.00				1.00	1.00	1.00	1.00	1.00	1.00
Percent Heavy Veh, %	5	5	5				0	5	5	5	5	0
Cap, veh/h	423	594	229				0	814	132	67	949	0
Arrive On Green	0.27	0.27	0.27				0.00	0.60	0.60	0.60	0.60	0.00
Sat Flow, veh/h	1551	2178	839				0	1360	221	22	1585	0
Grp Volume(v), veh/h	291	344	329				0	0	437	49	0	0
Grp Sat Flow(s),veh/h/ln	1551	1547	1470				0	0	1581	1607	0	0
Q Serve(g_s), s	11.8	14.5	14.7				0.0	0.0	10.7	0.0	0.0	0.0
Cycle Q Clear(g_c), s	11.8	14.5	14.7				0.0	0.0	10.7	0.9	0.0	0.0
Prop In Lane	1.00		0.57				0.00		0.14	0.04		0.00
Lane Grp Cap(c), veh/h	423	422	401				0	0	946	1016	0	0
V/C Ratio(X)	0.69	0.81	0.82				0.00	0.00	0.46	0.05	0.00	0.00
Avail Cap(c_a), veh/h	565	564	535				0	0	946	1016	0	0
HCM Platoon Ratio	1.00	1.00	1.00				1.00	1.00	1.00	1.00	1.00	1.00
Upstream Filter(I)	1.00	1.00	1.00				0.00	0.00	1.00	1.00	0.00	0.00
Uniform Delay (d), s/veh	22.8	23.8	23.9				0.0	0.0	7.8	5.8	0.0	0.0
Incr Delay (d2), s/veh	1.0	5.0	5.7				0.0	0.0	1.6	0.1	0.0	0.0
Initial Q Delay(d3),s/veh	0.0	0.0	0.0				0.0	0.0	0.0	0.0	0.0	0.0
%ile BackOfQ(50%),veh/ln	5.1	6.8	6.6				0.0	0.0	5.0	0.4	0.0	0.0
LnGrp Delay(d),s/veh	23.8	28.8	29.5				0.0	0.0	9.4	5.9	0.0	0.0
LnGrp LOS	C	C	C						A	A		
Approach Vol, veh/h		964						437			49	
Approach Delay, s/veh		27.5						9.4			5.9	
Approach LOS		C						A			A	
Timer	1	2	3	4	5	6	7	8				
Assigned Phs		2		4		6						
Phs Duration (G+Y+Rc), s		46.4		23.6		46.4						
Change Period (Y+Rc), s		4.5		4.5		4.5						
Max Green Setting (Gmax), s		35.5		25.5		35.5						
Max Q Clear Time (g_c+I1), s		12.7		16.7		2.9						
Green Ext Time (p_c), s		1.8		2.4		0.1						
Intersection Summary												
HCM 2010 Ctrl Delay			21.3									
HCM 2010 LOS			C									













9: Harrison St & Grand Ave
 HCM 2010 Signalized Intersection Summary

03/14/2019

												
Movement	EBL	EBT	EBR	WBL	WBT	WBR	NBL	NBT	NBR	SBL	SBT	SBR
Lane Configurations												
Traffic Volume (veh/h)	74	213	52	274	568	120	52	457	261	13	466	149
Future Volume (veh/h)	74	213	52	274	568	120	52	457	261	13	466	149
Number	3	8	18	7	4	14	5	2	12	1	6	16
Initial Q (Qb), veh	0	0	0	0	0	0	0	0	0	0	0	0
Ped-Bike Adj(A_pbT)	1.00		0.75	1.00		0.81	0.90		1.00	0.89		0.74
Parking Bus, Adj	1.00	1.00	1.00	1.00	1.00	1.00	1.00	1.00	1.00	1.00	1.00	1.00
Adj Sat Flow, veh/h/ln	1845	1845	1845	1845	1845	1900	1900	1845	1845	1900	1845	1845
Adj Flow Rate, veh/h	74	213	24	274	568	120	52	457	0	13	466	34
Adj No. of Lanes	2	2	1	2	2	0	0	3	1	0	2	1
Peak Hour Factor	1.00	1.00	1.00	1.00	1.00	1.00	1.00	1.00	1.00	1.00	1.00	1.00
Percent Heavy Veh, %	3	3	3	3	3	3	3	3	3	3	3	3
Cap, veh/h	160	1184	398	576	1319	277	141	1165	480	53	1030	355
Arrive On Green	0.05	0.34	0.34	0.17	0.48	0.48	0.31	0.31	0.00	0.31	0.31	0.31
Sat Flow, veh/h	3408	3505	1178	3408	2761	579	284	3803	1568	35	3361	1159
Grp Volume(v), veh/h	74	213	24	274	359	329	145	364	0	255	224	34
Grp Sat Flow(s),veh/h/ln	1704	1752	1178	1704	1752	1587	1032	1528	1568	1801	1595	1159
Q Serve(g_s), s	1.9	3.9	1.2	6.5	12.1	12.3	3.5	8.4	0.0	0.0	10.2	1.9
Cycle Q Clear(g_c), s	1.9	3.9	1.2	6.5	12.1	12.3	13.7	8.4	0.0	10.0	10.2	1.9
Prop In Lane	1.00		1.00	1.00		0.36	0.36		1.00	0.05		1.00
Lane Grp Cap(c), veh/h	160	1184	398	576	837	758	370	936	480	594	489	355
V/C Ratio(X)	0.46	0.18	0.06	0.48	0.43	0.43	0.39	0.39	0.00	0.43	0.46	0.10
Avail Cap(c_a), veh/h	189	1184	398	576	837	758	424	1066	547	668	556	404
HCM Platoon Ratio	1.00	1.00	1.00	1.00	1.00	1.00	1.00	1.00	1.00	1.00	1.00	1.00
Upstream Filter(I)	1.00	1.00	1.00	1.00	1.00	1.00	1.00	1.00	0.00	1.00	1.00	1.00
Uniform Delay (d), s/veh	41.8	21.0	20.1	33.8	15.4	15.5	25.6	24.6	0.0	25.1	25.2	22.3
Incr Delay (d2), s/veh	2.1	0.3	0.3	0.6	1.6	1.8	0.7	0.3	0.0	0.5	0.7	0.1
Initial Q Delay(d3),s/veh	0.0	0.0	0.0	0.0	0.0	0.0	0.0	0.0	0.0	0.0	0.0	0.0
%ile BackOfQ(50%),veh/ln	0.9	1.9	0.4	3.1	6.2	5.8	3.1	3.6	0.0	5.2	4.6	0.6
LnGrp Delay(d),s/veh	43.9	21.3	20.4	34.4	17.0	17.3	26.3	24.8	0.0	25.6	25.9	22.4
LnGrp LOS	D	C	C	C	B	B	C	C		C	C	C
Approach Vol, veh/h		311			962			509			513	
Approach Delay, s/veh		26.6			22.1			25.2			25.5	
Approach LOS		C			C			C			C	
Timer	1	2	3	4	5	6	7	8				
Assigned Phs		2	3	4		6	7	8				
Phs Duration (G+Y+Rc), s		33.2	8.2	48.6		33.2	20.8	36.0				
Change Period (Y+Rc), s		5.6	4.0	5.6		5.6	5.6	* 5.6				
Max Green Setting (Gmax), s		31.4	5.0	38.4		31.4	13.0	* 30				
Max Q Clear Time (g_c+I1), s		15.7	3.9	14.3		12.2	8.5	5.9				
Green Ext Time (p_c), s		3.1	0.0	4.7		2.9	0.4	1.4				
Intersection Summary												
HCM 2010 Ctrl Delay			24.2									
HCM 2010 LOS			C									
Notes												



















10: Lakeshore Ave & Foothill Blvd
 HCM 2010 Signalized Intersection Summary

03/14/2019

								
Movement	WBL	WBR	NBT	NBR	SBL	SBT		
Lane Configurations	 		 			 		
Traffic Volume (veh/h)	194	163	487	0	0	1002		
Future Volume (veh/h)	194	163	487	0	0	1002		
Number	3	18	2	12	1	6		
Initial Q (Qb), veh	0	0	0	0	0	0		
Ped-Bike Adj(A_pbT)	1.00	1.00		1.00	1.00			
Parking Bus, Adj	1.00	1.00	1.00	1.00	1.00	1.00		
Adj Sat Flow, veh/h/ln	1863	1900	1863	0	0	1863		
Adj Flow Rate, veh/h	178	180	487	0	0	1002		
Adj No. of Lanes	1	1	2	0	0	2		
Peak Hour Factor	1.00	1.00	1.00	1.00	1.00	1.00		
Percent Heavy Veh, %	2	0	2	0	0	2		
Cap, veh/h	234	213	2783	0	0	2783		
Arrive On Green	0.13	0.13	0.79	0.00	0.00	0.79		
Sat Flow, veh/h	1774	1615	3725	0	0	3725		
Grp Volume(v), veh/h	178	180	487	0	0	1002		
Grp Sat Flow(s),veh/h/ln	1774	1615	1770	0	0	1770		
Q Serve(g_s), s	10.6	12.0	3.8	0.0	0.0	9.3		
Cycle Q Clear(g_c), s	10.6	12.0	3.8	0.0	0.0	9.3		
Prop In Lane	1.00	1.00		0.00	0.00			
Lane Grp Cap(c), veh/h	234	213	2783	0	0	2783		
V/C Ratio(X)	0.76	0.84	0.18	0.00	0.00	0.36		
Avail Cap(c_a), veh/h	540	492	2783	0	0	2783		
HCM Platoon Ratio	1.00	1.00	1.00	1.00	1.00	1.00		
Upstream Filter(I)	1.00	1.00	1.00	0.00	0.00	1.00		
Uniform Delay (d), s/veh	46.1	46.6	2.9	0.0	0.0	3.5		
Incr Delay (d2), s/veh	1.9	3.5	0.1	0.0	0.0	0.4		
Initial Q Delay(d3),s/veh	0.0	0.0	0.0	0.0	0.0	0.0		
%ile BackOfQ(50%),veh/ln	5.4	5.6	1.9	0.0	0.0	4.6		
LnGrp Delay(d),s/veh	48.0	50.2	3.1	0.0	0.0	3.9		
LnGrp LOS	D	D	A			A		
Approach Vol, veh/h	358		487			1002		
Approach Delay, s/veh	49.1		3.1			3.9		
Approach LOS	D		A			A		
Timer	1	2	3	4	5	6	7	8
Assigned Phs		2				6		8
Phs Duration (G+Y+Rc), s		91.0				91.0		19.0
Change Period (Y+Rc), s		4.5				4.5		4.5
Max Green Setting (Gmax), s		67.5				67.5		33.5
Max Q Clear Time (g_c+I1), s		5.8				11.3		14.0
Green Ext Time (p_c), s		2.5				6.2		0.5
Intersection Summary								
HCM 2010 Ctrl Delay			12.4					
HCM 2010 LOS			B					
Notes								





















11: Lakeshore Ave & MacArthur Blvd
 HCM 2010 Signalized Intersection Summary

03/14/2019

												
Movement	EBL	EBT	EBR	WBL	WBT	WBR	NBL	NBT	NBR	SBL	SBT	SBR
Lane Configurations												
Traffic Volume (veh/h)	245	659	169	0	0	0	0	489	248	288	453	0
Future Volume (veh/h)	245	659	169	0	0	0	0	489	248	288	453	0
Number	7	4	14				5	2	12	1	6	16
Initial Q (Qb), veh	0	0	0				0	0	0	0	0	0
Ped-Bike Adj(A_pbT)	1.00		0.89				1.00		0.96	1.00		1.00
Parking Bus, Adj	1.00	1.00	1.00				1.00	1.00	1.00	1.00	1.00	1.00
Adj Sat Flow, veh/h/ln	1863	1863	1863				0	1863	1900	1863	1863	0
Adj Flow Rate, veh/h	226	686	103				0	489	248	288	453	0
Adj No. of Lanes	1	3	1				0	2	0	1	2	0
Peak Hour Factor	1.00	1.00	1.00				1.00	1.00	1.00	1.00	1.00	1.00
Percent Heavy Veh, %	2	2	2				0	2	2	2	2	0
Cap, veh/h	422	1329	337				0	742	374	549	2397	0
Arrive On Green	0.24	0.24	0.24				0.00	0.33	0.33	0.41	0.90	0.00
Sat Flow, veh/h	1774	5588	1416				0	2340	1133	1774	3632	0
Grp Volume(v), veh/h	226	686	103				0	384	353	288	453	0
Grp Sat Flow(s),veh/h/ln	1774	1863	1416				0	1770	1610	1774	1770	0
Q Serve(g_s), s	11.8	11.3	6.3				0.0	19.7	19.9	12.9	1.6	0.0
Cycle Q Clear(g_c), s	11.8	11.3	6.3				0.0	19.7	19.9	12.9	1.6	0.0
Prop In Lane	1.00		1.00				0.00		0.70	1.00		0.00
Lane Grp Cap(c), veh/h	422	1329	337				0	584	532	549	2397	0
V/C Ratio(X)	0.54	0.52	0.31				0.00	0.66	0.66	0.52	0.19	0.00
Avail Cap(c_a), veh/h	502	1582	401				0	584	532	549	2397	0
HCM Platoon Ratio	1.00	1.00	1.00				1.00	1.00	1.00	1.33	1.33	1.00
Upstream Filter(I)	1.00	1.00	1.00				0.00	1.00	1.00	0.64	0.64	0.00
Uniform Delay (d), s/veh	35.3	35.1	33.2				0.0	30.4	30.4	25.4	1.8	0.0
Incr Delay (d2), s/veh	0.4	0.1	0.2				0.0	5.7	6.4	0.3	0.1	0.0
Initial Q Delay(d3),s/veh	0.0	0.0	0.0				0.0	0.0	0.0	0.0	0.0	0.0
%ile BackOfQ(50%),veh/ln	5.8	5.8	2.5				0.0	10.5	9.8	6.3	0.8	0.0
LnGrp Delay(d),s/veh	35.7	35.2	33.4				0.0	36.1	36.8	25.6	1.9	0.0
LnGrp LOS	D	D	C					D	D	C	A	
Approach Vol, veh/h		1015						737			741	
Approach Delay, s/veh		35.1						36.5			11.1	
Approach LOS		D						D			B	
Timer	1	2	3	4	5	6	7	8				
Assigned Phs	1	2		4		6						
Phs Duration (G+Y+Rc), s	36.8	39.0		30.2		75.8						
Change Period (Y+Rc), s	4.0	* 4		5.0		4.0						
Max Green Setting (Gmax), s	28.5	* 35		30.0		67.0						
Max Q Clear Time (g_c+I1), s	14.9	21.9		13.8		3.6						
Green Ext Time (p_c), s	0.4	2.9		3.5		2.3						
Intersection Summary												
HCM 2010 Ctrl Delay			28.4									
HCM 2010 LOS			C									
Notes												

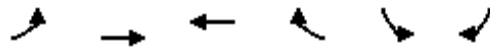
12: Lakeshore Ave & Lake Park Ave
 HCM 2010 Signalized Intersection Summary

03/14/2019

												
Movement	EBL	EBT	EBR	WBL	WBT	WBR	NBL	NBT	NBR	SBL	SBT	SBR
Lane Configurations												
Traffic Volume (veh/h)	39	0	54	352	641	191	334	397	0	0	343	235
Future Volume (veh/h)	39	0	54	352	641	191	334	397	0	0	343	235
Number	7	4	14	3	8	18	5	2	12	1	6	16
Initial Q (Qb), veh	0	0	0	0	0	0	0	0	0	0	0	0
Ped-Bike Adj(A_pbT)	1.00		0.98	1.00		1.00	1.00		1.00	1.00		0.77
Parking Bus, Adj	1.00	1.00	1.00	1.00	1.00	1.00	1.00	1.00	1.00	1.00	1.00	1.00
Adj Sat Flow, veh/h/ln	1863	1863	1900	1900	1863	1863	1863	1863	0	0	1863	1900
Adj Flow Rate, veh/h	39	0	54	352	641	0	334	397	0	0	343	235
Adj No. of Lanes	1	1	0	0	2	1	2	1	0	0	2	0
Peak Hour Factor	1.00	1.00	1.00	1.00	1.00	1.00	1.00	1.00	1.00	1.00	1.00	1.00
Percent Heavy Veh, %	2	2	2	2	2	2	2	2	0	0	2	2
Cap, veh/h	110	0	96	456	891	597	434	781	0	0	459	298
Arrive On Green	0.06	0.00	0.06	0.38	0.38	0.00	0.25	0.84	0.00	0.00	0.25	0.25
Sat Flow, veh/h	1774	0	1548	1210	2362	1583	3442	1863	0	0	1923	1187
Grp Volume(v), veh/h	39	0	54	524	469	0	334	397	0	0	331	247
Grp Sat Flow(s),veh/h/ln	1774	0	1548	1802	1770	1583	1721	1863	0	0	1770	1247
Q Serve(g_s), s	2.2	0.0	3.6	27.1	23.8	0.0	9.5	6.3	0.0	0.0	18.3	19.6
Cycle Q Clear(g_c), s	2.2	0.0	3.6	27.1	23.8	0.0	9.5	6.3	0.0	0.0	18.3	19.6
Prop In Lane	1.00		1.00	0.67		1.00	1.00		0.00	0.00		0.95
Lane Grp Cap(c), veh/h	110	0	96	680	668	597	434	781	0	0	444	313
V/C Ratio(X)	0.36	0.00	0.56	0.77	0.70	0.00	0.77	0.51	0.00	0.00	0.75	0.79
Avail Cap(c_a), veh/h	117	0	102	680	668	597	435	781	0	0	444	313
HCM Platoon Ratio	1.00	1.00	1.00	1.00	1.00	1.00	2.00	2.00	1.00	1.00	1.00	1.00
Upstream Filter(I)	1.00	0.00	1.00	1.00	1.00	0.00	0.80	0.80	0.00	0.00	1.00	1.00
Uniform Delay (d), s/veh	47.7	0.0	48.3	29.0	27.9	0.0	38.2	5.5	0.0	0.0	36.6	37.1
Incr Delay (d2), s/veh	0.7	0.0	3.2	8.3	6.1	0.0	6.0	1.9	0.0	0.0	10.9	18.0
Initial Q Delay(d3),s/veh	0.0	0.0	0.0	0.0	0.0	0.0	0.0	0.0	0.0	0.0	0.0	0.0
%ile BackOfQ(50%),veh/ln	1.1	0.0	1.6	15.0	12.7	0.0	4.9	3.5	0.0	0.0	10.3	8.3
LnGrp Delay(d),s/veh	48.4	0.0	51.5	37.2	34.0	0.0	44.3	7.4	0.0	0.0	47.4	55.1
LnGrp LOS	D		D	D	C		D	A			D	E
Approach Vol, veh/h		93			993			731			578	
Approach Delay, s/veh		50.2			35.7			24.2			50.7	
Approach LOS		D			D			C			D	
Timer	1	2	3	4	5	6	7	8				
Assigned Phs		2		4	5	6		8				
Phs Duration (G+Y+Rc), s		49.0		12.0	17.9	31.1		45.0				
Change Period (Y+Rc), s		4.5		5.5	4.5	* 4.5		5.0				
Max Green Setting (Gmax), s		44.0		7.0	13.4	* 27		40.0				
Max Q Clear Time (g_c+I1), s		8.3		5.6	11.5	21.6		29.1				
Green Ext Time (p_c), s		1.8		0.0	0.2	1.4		3.4				
Intersection Summary												
HCM 2010 Ctrl Delay			36.4									
HCM 2010 LOS			D									
Notes												

13: Embarcadero W & 880 On-Ramp
 HCM 2010 Signalized Intersection Summary




























03/14/2019



Movement	EBL	EBT	WBT	WBR	SBL	SBR		
Lane Configurations								
Traffic Volume (veh/h)	668	349	453	101	0	0		
Future Volume (veh/h)	668	349	453	101	0	0		
Number	7	4	8	18				
Initial Q (Qb), veh	0	0	0	0				
Ped-Bike Adj(A_pbT)	1.00			1.00				
Parking Bus, Adj	1.00	1.00	1.00	1.00				
Adj Sat Flow, veh/h/ln	1827	1827	1827	1900				
Adj Flow Rate, veh/h	668	349	453	0				
Adj No. of Lanes	1	2	1	0				
Peak Hour Factor	1.00	1.00	1.00	1.00				
Percent Heavy Veh, %	4	4	4	4				
Cap, veh/h	695	3298	915	0				
Arrive On Green	0.67	1.00	0.50	0.00				
Sat Flow, veh/h	1740	3563	1827	0				
Grp Volume(v), veh/h	668	349	453	0				
Grp Sat Flow(s),veh/h/ln	1740	1736	1827	0				
Q Serve(g_s), s	32.1	0.0	14.8	0.0				
Cycle Q Clear(g_c), s	32.1	0.0	14.8	0.0				
Prop In Lane	1.00			0.00				
Lane Grp Cap(c), veh/h	695	3298	915	0				
V/C Ratio(X)	0.96	0.11	0.50	0.00				
Avail Cap(c_a), veh/h	860	3298	915	0				
HCM Platoon Ratio	1.67	1.67	1.00	1.00				
Upstream Filter(I)	1.00	1.00	1.00	0.00				
Uniform Delay (d), s/veh	14.3	0.0	14.9	0.0				
Incr Delay (d2), s/veh	19.6	0.1	1.9	0.0				
Initial Q Delay(d3),s/veh	0.0	0.0	0.0	0.0				
%ile BackOfQ(50%),veh/ln	18.6	0.0	7.9	0.0				
LnGrp Delay(d),s/veh	34.0	0.1	16.8	0.0				
LnGrp LOS	C	A	B					
Approach Vol, veh/h		1017	453					
Approach Delay, s/veh		22.3	16.8					
Approach LOS		C	B					
Timer	1	2	3	4	5	6	7	8
Assigned Phs				4			7	8
Phs Duration (G+Y+Rc), s				90.0			40.4	49.6
Change Period (Y+Rc), s				4.5			4.5	4.5
Max Green Setting (Gmax), s				85.5			44.5	36.5
Max Q Clear Time (g_c+I1), s				2.0			34.1	16.8
Green Ext Time (p_c), s				2.6			1.9	2.8
Intersection Summary								
HCM 2010 Ctrl Delay			20.6					
HCM 2010 LOS			C					



















14: 5th Ave & E 8th St
 HCM 2010 Signalized Intersection Summary

03/14/2019

												
Movement	EBL	EBT	EBR	WBL	WBT	WBR	NBL	NBT	NBR	SBL	SBT	SBR
Lane Configurations		  			 						 	
Traffic Volume (veh/h)	82	206	67	101	527	1	141	303	127	7	344	142
Future Volume (veh/h)	82	206	67	101	527	1	141	303	127	7	344	142
Number	7	4	14	3	8	18	5	2	12	1	6	16
Initial Q (Qb), veh	0	0	0	0	0	0	0	0	0	0	0	0
Ped-Bike Adj(A_pbT)	1.00		0.97	0.99		0.96	1.00		0.98	1.00		0.98
Parking Bus, Adj	1.00	1.00	1.00	1.00	1.00	1.00	1.00	1.00	1.00	1.00	1.00	1.00
Adj Sat Flow, veh/h/ln	1845	1845	1845	1845	1845	1900	1845	1845	1845	1845	1845	1845
Adj Flow Rate, veh/h	82	206	29	101	527	1	141	303	59	7	344	66
Adj No. of Lanes	1	3	1	1	2	0	1	1	1	1	1	1
Peak Hour Factor	1.00	1.00	1.00	1.00	1.00	1.00	1.00	1.00	1.00	1.00	1.00	1.00
Percent Heavy Veh, %	3	3	3	3	3	3	3	3	3	3	3	3
Cap, veh/h	245	1421	427	391	1012	2	612	1129	943	647	1129	943
Arrive On Green	0.28	0.28	0.28	0.28	0.28	0.28	0.61	0.61	0.61	0.61	0.61	0.61
Sat Flow, veh/h	860	5036	1514	1121	3589	7	961	1845	1541	1005	1845	1542
Grp Volume(v), veh/h	82	206	29	101	257	271	141	303	59	7	344	66
Grp Sat Flow(s),veh/h/ln	860	1679	1514	1121	1752	1843	961	1845	1541	1005	1845	1542
Q Serve(g_s), s	5.9	2.0	0.9	4.9	8.2	8.2	5.4	5.0	1.0	0.2	5.9	1.1
Cycle Q Clear(g_c), s	14.0	2.0	0.9	6.9	8.2	8.2	11.3	5.0	1.0	5.2	5.9	1.1
Prop In Lane	1.00		1.00	1.00		0.00	1.00		1.00	1.00		1.00
Lane Grp Cap(c), veh/h	245	1421	427	391	494	520	612	1129	943	647	1129	943
V/C Ratio(X)	0.33	0.15	0.07	0.26	0.52	0.52	0.23	0.27	0.06	0.01	0.30	0.07
Avail Cap(c_a), veh/h	374	2175	654	559	757	796	612	1129	943	647	1129	943
HCM Platoon Ratio	1.00	1.00	1.00	1.00	1.00	1.00	1.00	1.00	1.00	1.00	1.00	1.00
Upstream Filter(I)	1.00	1.00	1.00	1.00	1.00	1.00	1.00	1.00	1.00	1.00	1.00	1.00
Uniform Delay (d), s/veh	25.8	17.7	17.3	20.3	19.9	19.9	8.8	5.9	5.2	7.2	6.1	5.2
Incr Delay (d2), s/veh	0.8	0.0	0.1	0.3	0.9	0.8	0.9	0.6	0.1	0.0	0.7	0.1
Initial Q Delay(d3),s/veh	0.0	0.0	0.0	0.0	0.0	0.0	0.0	0.0	0.0	0.0	0.0	0.0
%ile BackOfQ(50%),veh/ln	1.4	0.9	0.4	1.6	4.0	4.3	1.6	2.7	0.5	0.1	3.2	0.5
LnGrp Delay(d),s/veh	26.6	17.8	17.4	20.7	20.8	20.7	9.7	6.5	5.3	7.2	6.8	5.3
LnGrp LOS	C	B	B	C	C	C	A	A	A	A	A	A
Approach Vol, veh/h		317			629			503			417	
Approach Delay, s/veh		20.0			20.7			7.3			6.6	
Approach LOS		C			C			A			A	
Timer	1	2	3	4	5	6	7	8				
Assigned Phs		2		4		6		8				
Phs Duration (G+Y+Rc), s		43.9		22.1		43.9		22.1				
Change Period (Y+Rc), s		3.5		3.5		3.5		3.5				
Max Green Setting (Gmax), s		31.0		28.5		31.0		28.5				
Max Q Clear Time (g_c+I1), s		13.3		16.0		7.9		10.2				
Green Ext Time (p_c), s		2.6		1.5		2.3		3.3				
Intersection Summary												
HCM 2010 Ctrl Delay			13.8									
HCM 2010 LOS			B									

15: E 8th St/14th Ave & E 12th St
 HCM 2010 Signalized Intersection Summary

03/14/2019

												
Movement	EBL	EBT	EBR	WBL	WBT	WBR	NBL	NBT	NBR	SBL	SBT	SBR
Lane Configurations												
Traffic Volume (veh/h)	106	144	7	0	0	0	0	172	0	244	299	0
Future Volume (veh/h)	106	144	7	0	0	0	0	172	0	244	299	0
Number	1	6	16				7	4	14	3	8	18
Initial Q (Qb), veh	0	0	0				0	0	0	0	0	0
Ped-Bike Adj(A_pbT)	1.00		1.00				1.00		1.00	1.00		1.00
Parking Bus, Adj	1.00	1.00	1.00				1.00	1.00	1.00	1.00	1.00	1.00
Adj Sat Flow, veh/h/ln	1863	1863	1900				0	1863	0	1863	1863	0
Adj Flow Rate, veh/h	106	144	0				0	172	0	244	299	0
Adj No. of Lanes	1	2	0				0	2	0	1	3	0
Peak Hour Factor	1.00	1.00	1.00				1.00	1.00	1.00	1.00	1.00	1.00
Percent Heavy Veh, %	2	2	2				0	2	0	2	2	0
Cap, veh/h	491	980	0				0	817	0	861	2895	0
Arrive On Green	0.28	0.28	0.00				0.00	0.23	0.00	0.29	0.57	0.00
Sat Flow, veh/h	1774	3632	0				0	3725	0	1774	5253	0
Grp Volume(v), veh/h	106	144	0				0	172	0	244	299	0
Grp Sat Flow(s),veh/h/ln	1774	1770	0				0	1770	0	1774	1695	0
Q Serve(g_s), s	3.0	2.0	0.0				0.0	2.6	0.0	4.6	1.7	0.0
Cycle Q Clear(g_c), s	3.0	2.0	0.0				0.0	2.6	0.0	4.6	1.7	0.0
Prop In Lane	1.00		0.00				0.00		0.00	1.00		0.00
Lane Grp Cap(c), veh/h	491	980	0				0	817	0	861	2895	0
V/C Ratio(X)	0.22	0.15	0.00				0.00	0.21	0.00	0.28	0.10	0.00
Avail Cap(c_a), veh/h	491	980	0				0	817	0	861	2895	0
HCM Platoon Ratio	1.00	1.00	1.00				1.00	1.00	1.00	1.00	1.00	1.00
Upstream Filter(I)	1.00	1.00	0.00				0.00	1.00	0.00	1.00	1.00	0.00
Uniform Delay (d), s/veh	18.1	17.7	0.0				0.0	20.2	0.0	7.7	6.4	0.0
Incr Delay (d2), s/veh	1.0	0.3	0.0				0.0	0.6	0.0	0.8	0.1	0.0
Initial Q Delay(d3),s/veh	0.0	0.0	0.0				0.0	0.0	0.0	0.0	0.0	0.0
%ile BackOfQ(50%),veh/ln	1.6	1.0	0.0				0.0	1.3	0.0	2.4	0.8	0.0
LnGrp Delay(d),s/veh	19.1	18.0	0.0				0.0	20.8	0.0	8.5	6.5	0.0
LnGrp LOS	B	B						C		A	A	
Approach Vol, veh/h		250						172			543	
Approach Delay, s/veh		18.5						20.8			7.4	
Approach LOS		B						C			A	
Timer	1	2	3	4	5	6	7	8				
Assigned Phs			3	4		6		8				
Phs Duration (G+Y+Rc), s			22.0	20.0		23.0		42.0				
Change Period (Y+Rc), s			3.0	5.0		5.0		5.0				
Max Green Setting (Gmax), s			19.0	15.0		18.0		37.0				
Max Q Clear Time (g_c+I1), s			6.6	4.6		5.0		3.7				
Green Ext Time (p_c), s			0.0	0.1		0.1		0.5				
Intersection Summary												
HCM 2010 Ctrl Delay			12.7									
HCM 2010 LOS			B									

16: Foothill & 14th Ave
 HCM Signalized Intersection Capacity Analysis



















03/14/2019



Movement	EBL	EBT	EBR	WBL	WBT	WBR	NBL	NBT	NBR	SBL	SBT	SBR
Lane Configurations					↑↑						↑↑	
Traffic Volume (vph)	0	0	0	71	297	0	0	0	0	88	906	162
Future Volume (vph)	0	0	0	71	297	0	0	0	0	88	906	162
Ideal Flow (vphpl)	1900	1900	1900	1900	1900	1900	1900	1900	1900	1900	1900	1900
Total Lost time (s)					5.5						4.0	
Lane Util. Factor					0.95						0.95	
Frbp, ped/bikes					1.00						0.99	
Flpb, ped/bikes					1.00						1.00	
Frt					1.00						0.98	
Flt Protected					0.99						1.00	
Satd. Flow (prot)					3505						3434	
Flt Permitted					0.99						1.00	
Satd. Flow (perm)					3505						3434	
Peak-hour factor, PHF	1.00	1.00	1.00	1.00	1.00	1.00	1.00	1.00	1.00	1.00	1.00	1.00
Adj. Flow (vph)	0	0	0	71	297	0	0	0	0	88	906	162
RTOR Reduction (vph)	0	0	0	0	0	0	0	0	0	0	10	0
Lane Group Flow (vph)	0	0	0	0	368	0	0	0	0	0	1146	0
Confl. Peds. (#/hr)	20		12			20	12					12
Confl. Bikes (#/hr)						16						8
Turn Type				Split	NA					Split	NA	
Protected Phases				5	5					6	6	
Permitted Phases												
Actuated Green, G (s)					22.5						67.1	
Effective Green, g (s)					22.5						67.1	
Actuated g/C Ratio					0.19						0.56	
Clearance Time (s)					5.5						4.0	
Vehicle Extension (s)					0.2						0.2	
Lane Grp Cap (vph)					657						1920	
v/s Ratio Prot					c0.10						c0.33	
v/s Ratio Perm												
v/c Ratio					0.56						0.60	
Uniform Delay, d1					44.3						17.5	
Progression Factor					2.01						1.00	
Incremental Delay, d2					0.5						1.4	
Delay (s)					89.3						18.9	
Level of Service					F						B	
Approach Delay (s)		0.0			89.3			0.0			18.9	
Approach LOS		A			F			A			B	
Intersection Summary												
HCM 2000 Control Delay			35.9									HCM 2000 Level of Service D
HCM 2000 Volume to Capacity ratio			0.50									
Actuated Cycle Length (s)			120.0							15.0		Sum of lost time (s)
Intersection Capacity Utilization			54.4%									ICU Level of Service A
Analysis Period (min)			15									
c Critical Lane Group												

17: 14th Ave & Foothill Blvd
 HCM Signalized Intersection Capacity Analysis

03/14/2019

													
Movement	EBL	EBT	EBR	WBL	WBT	WBR	NBL	NBT	NBR	SBL	SBT	SBR	
Lane Configurations		 			 			 					
Traffic Volume (vph)	2	86	0	0	368	1	0	433	104	0	0	0	
Future Volume (vph)	2	86	0	0	368	1	0	433	104	0	0	0	
Ideal Flow (vphpl)	1900	1900	1900	1900	1900	1900	1900	1900	1900	1900	1900	1900	
Total Lost time (s)		5.5			5.5			4.0					
Lane Util. Factor		0.95			0.95			0.95					
Frbp, ped/bikes		1.00			1.00			1.00					
Flpb, ped/bikes		1.00			1.00			1.00					
Frt		1.00			1.00			0.97					
Flt Protected		1.00			1.00			1.00					
Satd. Flow (prot)		3501			3503			3392					
Flt Permitted		0.95			1.00			1.00					
Satd. Flow (perm)		3336			3503			3392					
Peak-hour factor, PHF	1.00	1.00	1.00	1.00	1.00	1.00	1.00	1.00	1.00	1.00	1.00	1.00	
Adj. Flow (vph)	2	86	0	0	368	1	0	433	104	0	0	0	
RTOR Reduction (vph)	0	0	0	0	0	0	0	15	0	0	0	0	
Lane Group Flow (vph)	0	88	0	0	369	0	0	522	0	0	0	0	
Confl. Peds. (#/hr)			7	7		17			2	2			
Confl. Bikes (#/hr)			1			13			5				
Heavy Vehicles (%)	3%	3%	3%	3%	3%	3%	3%	3%	3%	3%	3%	3%	
Turn Type	custom	NA			NA			NA					
Protected Phases	1	4	1		8			2					
Permitted Phases	4												
Actuated Green, G (s)		21.0			15.4			85.0					
Effective Green, g (s)		21.0			15.4			85.0					
Actuated g/C Ratio		0.18			0.13			0.71					
Clearance Time (s)					5.5			4.0					
Vehicle Extension (s)					0.2			0.2					
Lane Grp Cap (vph)		591			449			2402					
v/s Ratio Prot		c0.01			c0.11			c0.15					
v/s Ratio Perm		0.02											
v/c Ratio		0.15			0.82			0.22					
Uniform Delay, d1		41.9			51.0			6.0					
Progression Factor		1.80			1.00			1.00					
Incremental Delay, d2		0.0			11.0			0.2					
Delay (s)		75.5			62.0			6.2					
Level of Service		E			E			A					
Approach Delay (s)		75.5			62.0			6.2			0.0		
Approach LOS		E			E			A			A		
Intersection Summary													
HCM 2000 Control Delay			33.1									HCM 2000 Level of Service	C
HCM 2000 Volume to Capacity ratio			0.30										
Actuated Cycle Length (s)			120.0									Sum of lost time (s)	15.0
Intersection Capacity Utilization			34.2%									ICU Level of Service	A
Analysis Period (min)			15										
c Critical Lane Group													

18: 23rd Ave & 16th St
 HCM Signalized Intersection Capacity Analysis















03/14/2019



Movement	WBL	WBR	NBT	NBR	SBL	SBT
Lane Configurations	↔		↑			↓
Traffic Volume (vph)	7	57	210	10	24	392
Future Volume (vph)	7	57	210	10	24	392
Ideal Flow (vphpl)	1900	1900	1900	1900	1900	1900
Total Lost time (s)	4.0		4.0			4.0
Lane Util. Factor	1.00		1.00			1.00
Frbp, ped/bikes	0.97		1.00			1.00
Flpb, ped/bikes	1.00		1.00			1.00
Frt	0.88		0.99			1.00
Flt Protected	0.99		1.00			1.00
Satd. Flow (prot)	1568		1828			1836
Flt Permitted	0.99		1.00			0.98
Satd. Flow (perm)	1568		1828			1803
Peak-hour factor, PHF	1.00	1.00	1.00	1.00	1.00	1.00
Adj. Flow (vph)	7	57	210	10	24	392
RTOR Reduction (vph)	50	0	2	0	0	0
Lane Group Flow (vph)	14	0	218	0	0	416
Confl. Peds. (#/hr)		2		33	33	
Confl. Bikes (#/hr)		1		2		
Heavy Vehicles (%)	3%	3%	3%	3%	3%	3%
Turn Type	Prot		NA		Perm	NA
Protected Phases	7		2			2
Permitted Phases					2	
Actuated Green, G (s)	6.2		27.2			27.2
Effective Green, g (s)	6.2		27.2			27.2
Actuated g/C Ratio	0.12		0.50			0.50
Clearance Time (s)	4.0		4.0			4.0
Vehicle Extension (s)	3.0		3.0			3.0
Lane Grp Cap (vph)	180		922			909
v/s Ratio Prot	c0.01		0.12			
v/s Ratio Perm						c0.23
v/c Ratio	0.08		0.24			0.46
Uniform Delay, d1	21.3		7.5			8.6
Progression Factor	1.00		1.00			0.21
Incremental Delay, d2	0.2		0.1			0.3
Delay (s)	21.5		7.6			2.2
Level of Service	C		A			A
Approach Delay (s)	21.5		7.6			2.2
Approach LOS	C		A			A
Intersection Summary						
HCM 2000 Control Delay			5.6		HCM 2000 Level of Service	A
HCM 2000 Volume to Capacity ratio			0.31			
Actuated Cycle Length (s)			53.9		Sum of lost time (s)	12.0
Intersection Capacity Utilization			50.6%		ICU Level of Service	A
Analysis Period (min)			15			
c Critical Lane Group						













19: 7th Ave & Embarcadero W
 HCM 2010 Signalized Intersection Summary

03/14/2019

								
Movement	EBT	EBR	WBL	WBT	NBL	NBR		
Lane Configurations	 			 		 		
Traffic Volume (veh/h)	927	43	20	543	120	54		
Future Volume (veh/h)	927	43	20	543	120	54		
Number	4	14	3	8	5	12		
Initial Q (Qb), veh	0	0	0	0	0	0		
Ped-Bike Adj(A_pbT)		0.81	0.96		1.00	1.00		
Parking Bus, Adj	1.00	1.00	1.00	1.00	1.00	1.00		
Adj Sat Flow, veh/h/ln	1863	1900	1863	1863	1863	1863		
Adj Flow Rate, veh/h	927	43	20	543	120	20		
Adj No. of Lanes	2	0	1	2	1	1		
Peak Hour Factor	1.00	1.00	1.00	1.00	1.00	1.00		
Percent Heavy Veh, %	2	2	2	2	2	2		
Cap, veh/h	2136	99	426	2222	483	431		
Arrive On Green	1.00	1.00	1.00	1.00	0.27	0.27		
Sat Flow, veh/h	3496	158	552	3632	1774	1583		
Grp Volume(v), veh/h	482	488	20	543	120	20		
Grp Sat Flow(s),veh/h/ln	1770	1791	552	1770	1774	1583		
Q Serve(g_s), s	0.0	0.0	0.0	0.0	4.8	0.8		
Cycle Q Clear(g_c), s	0.0	0.0	0.0	0.0	4.8	0.8		
Prop In Lane		0.09	1.00		1.00	1.00		
Lane Grp Cap(c), veh/h	1111	1124	426	2222	483	431		
V/C Ratio(X)	0.43	0.43	0.05	0.24	0.25	0.05		
Avail Cap(c_a), veh/h	1111	1124	426	2222	483	431		
HCM Platoon Ratio	2.00	2.00	2.00	2.00	1.00	1.00		
Upstream Filter(I)	0.88	0.88	0.94	0.94	1.00	1.00		
Uniform Delay (d), s/veh	0.0	0.0	0.0	0.0	25.6	24.1		
Incr Delay (d2), s/veh	1.1	1.1	0.2	0.2	1.2	0.2		
Initial Q Delay(d3),s/veh	0.0	0.0	0.0	0.0	0.0	0.0		
%ile BackOfQ(50%),veh/ln	0.3	0.3	0.0	0.1	2.5	0.4		
LnGrp Delay(d),s/veh	1.1	1.1	0.2	0.2	26.8	24.3		
LnGrp LOS	A	A	A	A	C	C		
Approach Vol, veh/h	970			563	140			
Approach Delay, s/veh	1.1			0.2	26.4			
Approach LOS	A			A	C			
Timer	1	2	3	4	5	6	7	8
Assigned Phs		2		4				8
Phs Duration (G+Y+Rc), s		29.0		61.0				61.0
Change Period (Y+Rc), s		4.5		4.5				4.5
Max Green Setting (Gmax), s		24.5		56.5				56.5
Max Q Clear Time (g_c+I1), s		6.8		2.0				2.0
Green Ext Time (p_c), s		0.3		8.1				4.5
Intersection Summary								
HCM 2010 Ctrl Delay			2.9					
HCM 2010 LOS			A					

20: 8th Ave & Embarcadero W
 HCM 2010 Signalized Intersection Summary

03/14/2019

								
Movement	EBT	EBR	WBL	WBT	NBL	NBR		
Lane Configurations	 							
Traffic Volume (veh/h)	943	38	10	443	120	59		
Future Volume (veh/h)	943	38	10	443	120	59		
Number	4	14	3	8	5	12		
Initial Q (Qb), veh	0	0	0	0	0	0		
Ped-Bike Adj(A_pbT)		1.00	1.00		1.00	1.00		
Parking Bus, Adj	1.00	1.00	1.00	1.00	1.00	1.00		
Adj Sat Flow, veh/h/ln	1863	1900	1863	1863	1863	1863		
Adj Flow Rate, veh/h	943	38	10	443	120	17		
Adj No. of Lanes	2	0	1	1	1	1		
Peak Hour Factor	1.00	1.00	1.00	1.00	1.00	1.00		
Percent Heavy Veh, %	2	2	2	2	2	2		
Cap, veh/h	2139	86	432	1149	503	449		
Arrive On Green	1.00	1.00	1.00	1.00	0.28	0.28		
Sat Flow, veh/h	3561	140	571	1863	1774	1583		
Grp Volume(v), veh/h	481	500	10	443	120	17		
Grp Sat Flow(s),veh/h/ln	1770	1838	571	1863	1774	1583		
Q Serve(g_s), s	0.0	0.0	0.0	0.0	4.7	0.7		
Cycle Q Clear(g_c), s	0.0	0.0	0.0	0.0	4.7	0.7		
Prop In Lane		0.08	1.00		1.00	1.00		
Lane Grp Cap(c), veh/h	1091	1133	432	1149	503	449		
V/C Ratio(X)	0.44	0.44	0.02	0.39	0.24	0.04		
Avail Cap(c_a), veh/h	1091	1133	432	1149	503	449		
HCM Platoon Ratio	2.00	2.00	2.00	2.00	1.00	1.00		
Upstream Filter(I)	0.90	0.90	1.00	1.00	1.00	1.00		
Uniform Delay (d), s/veh	0.0	0.0	0.0	0.0	24.8	23.4		
Incr Delay (d2), s/veh	1.2	1.1	0.1	1.0	1.1	0.2		
Initial Q Delay(d3),s/veh	0.0	0.0	0.0	0.0	0.0	0.0		
%ile BackOfQ(50%),veh/ln	0.4	0.4	0.0	0.3	2.5	0.3		
LnGrp Delay(d),s/veh	1.2	1.1	0.1	1.0	25.9	23.5		
LnGrp LOS	A	A	A	A	C	C		
Approach Vol, veh/h	981			453	137			
Approach Delay, s/veh	1.1			1.0	25.6			
Approach LOS	A			A	C			
Timer	1	2	3	4	5	6	7	8
Assigned Phs		2		4				8
Phs Duration (G+Y+Rc), s		30.0		60.0				60.0
Change Period (Y+Rc), s		4.5		4.5				4.5
Max Green Setting (Gmax), s		25.5		55.5				55.5
Max Q Clear Time (g_c+I1), s		6.7		2.0				2.0
Green Ext Time (p_c), s		0.3		8.1				3.3
Intersection Summary								
HCM 2010 Ctrl Delay			3.2					
HCM 2010 LOS			A					

Intersection						
Int Delay, s/veh	0.9					
Movement	EBT	EBR	WBL	WBT	NBL	NBR
Lane Configurations	↑↑			↑		↑
Traffic Vol, veh/h	968	34	0	453	0	58
Future Vol, veh/h	968	34	0	453	0	58
Conflicting Peds, #/hr	0	270	0	0	0	0
Sign Control	Free	Free	Free	Free	Stop	Stop
RT Channelized	-	None	-	None	-	None
Storage Length	-	-	-	-	-	0
Veh in Median Storage, #	0	-	-	0	0	-
Grade, %	0	-	-	0	0	-
Peak Hour Factor	100	100	100	100	100	100
Heavy Vehicles, %	2	2	2	2	2	2
Mvmt Flow	968	34	0	453	0	58












Major/Minor	Major1	Major2	Minor1			
Conflicting Flow All	0	0	-	-	-	771
Stage 1	-	-	-	-	-	-
Stage 2	-	-	-	-	-	-
Critical Hdwy	-	-	-	-	-	6.93
Critical Hdwy Stg 1	-	-	-	-	-	-
Critical Hdwy Stg 2	-	-	-	-	-	-
Follow-up Hdwy	-	-	-	-	-	3.319
Pot Cap-1 Maneuver	-	-	0	-	0	344
Stage 1	-	-	0	-	0	-
Stage 2	-	-	0	-	0	-
Platoon blocked, %	-	-	-	-	-	-
Mov Cap-1 Maneuver	-	-	-	-	-	256
Mov Cap-2 Maneuver	-	-	-	-	-	-
Stage 1	-	-	-	-	-	-
Stage 2	-	-	-	-	-	-

Approach	EB	WB	NB
HCM Control Delay, s	0	0	23.1
HCM LOS			C

Minor Lane/Major Mvmt	NBLn1	EBT	EBR	WBT
Capacity (veh/h)	256	-	-	-
HCM Lane V/C Ratio	0.227	-	-	-
HCM Control Delay (s)	23.1	-	-	-
HCM Lane LOS	C	-	-	-
HCM 95th %tile Q(veh)	0.8	-	-	-

22: 4th Ave & Embarcadero W
 HCM 2010 Signalized Intersection Summary













03/14/2019

								
Movement	EBT	EBR	WBL	WBT	NBL	NBR		
Lane Configurations								
Traffic Volume (veh/h)	276	5	9	803	70	94		
Future Volume (veh/h)	276	5	9	803	70	94		
Number	4	14	3	8	5	12		
Initial Q (Qb), veh	0	0	0	0	0	0		
Ped-Bike Adj(A_pbT)		0.64	0.81		1.00	1.00		
Parking Bus, Adj	1.00	1.00	1.00	1.00	1.00	1.00		
Adj Sat Flow, veh/h/ln	1863	1900	1863	1863	1863	1863		
Adj Flow Rate, veh/h	300	5	10	873	76	59		
Adj No. of Lanes	1	0	1	2	1	1		
Peak Hour Factor	0.92	0.92	0.92	0.92	0.92	0.92		
Percent Heavy Veh, %	2	2	2	2	2	2		
Cap, veh/h	723	12	404	1416	710	633		
Arrive On Green	0.40	0.40	0.53	0.53	0.40	0.40		
Sat Flow, veh/h	1808	30	869	3632	1774	1583		
Grp Volume(v), veh/h	0	305	10	873	76	59		
Grp Sat Flow(s),veh/h/ln	0	1838	869	1770	1774	1583		
Q Serve(g_s), s	0.0	5.4	0.3	7.7	1.2	1.0		
Cycle Q Clear(g_c), s	0.0	5.4	5.7	7.7	1.2	1.0		
Prop In Lane		0.02	1.00		1.00	1.00		
Lane Grp Cap(c), veh/h	0	735	404	1416	710	633		
V/C Ratio(X)	0.00	0.41	0.02	0.62	0.11	0.09		
Avail Cap(c_a), veh/h	0	735	404	1416	710	633		
HCM Platoon Ratio	1.00	1.00	1.33	1.33	1.00	1.00		
Upstream Filter(I)	0.00	1.00	0.77	0.77	1.00	1.00		
Uniform Delay (d), s/veh	0.0	9.7	9.4	8.1	8.5	8.4		
Incr Delay (d2), s/veh	0.0	1.7	0.1	1.6	0.3	0.3		
Initial Q Delay(d3),s/veh	0.0	0.0	0.0	0.0	0.0	0.0		
%ile BackOfQ(50%),veh/ln	0.0	3.1	0.1	4.0	0.7	0.5		
LnGrp Delay(d),s/veh	0.0	11.4	9.4	9.7	8.8	8.7		
LnGrp LOS		B	A	A	A	A		
Approach Vol, veh/h	305			883	135			
Approach Delay, s/veh	11.4			9.7	8.7			
Approach LOS	B			A	A			
Timer	1	2	3	4	5	6	7	8
Assigned Phs		2		4				8
Phs Duration (G+Y+Rc), s		22.5		22.5				22.5
Change Period (Y+Rc), s		4.5		4.5				4.5
Max Green Setting (Gmax), s		18.0		18.0				18.0
Max Q Clear Time (g_c+1), s		3.2		7.4				9.7
Green Ext Time (p_c), s		0.3		1.3				3.8
Intersection Summary								
HCM 2010 Ctrl Delay			10.0					
HCM 2010 LOS			A					

HCM 2010 Signalized Intersection Summary

1: Embarcadero W & Oak St

05/05/2020

								
Movement	EBL	EBR	NBL	NBT	SBT	SBR		
Lane Configurations								
Traffic Volume (veh/h)	138	323	242	614	823	31		
Future Volume (veh/h)	138	323	242	614	823	31		
Number	7	14	5	2	6	16		
Initial Q (Qb), veh	0	0	0	0	0	0		
Ped-Bike Adj(A_pbT)	1.00	1.00	1.00			0.94		
Parking Bus, Adj	1.00	1.00	1.00	1.00	1.00	1.00		
Adj Sat Flow, veh/h/ln	1676	1676	1676	1676	1676	1710		
Adj Flow Rate, veh/h	138	323	242	614	823	31		
Adj No. of Lanes	1	1	1	1	1	0		
Peak Hour Factor	1.00	1.00	1.00	1.00	1.00	1.00		
Percent Heavy Veh, %	2	2	2	2	2	2		
Cap, veh/h	404	360	232	1057	1009	38		
Arrive On Green	0.25	0.25	0.63	0.63	0.63	0.63		
Sat Flow, veh/h	1597	1425	579	1676	1601	60		
Grp Volume(v), veh/h	138	323	242	614	0	854		
Grp Sat Flow(s),veh/h/ln	1597	1425	579	1676	0	1662		
Q Serve(g_s), s	5.4	16.9	18.4	16.4	0.0	30.1		
Cycle Q Clear(g_c), s	5.4	16.9	48.5	16.4	0.0	30.1		
Prop In Lane	1.00	1.00	1.00			0.04		
Lane Grp Cap(c), veh/h	404	360	232	1057	0	1047		
V/C Ratio(X)	0.34	0.90	1.04	0.58	0.00	0.82		
Avail Cap(c_a), veh/h	467	417	232	1057	0	1047		
HCM Platoon Ratio	1.00	1.00	1.00	1.00	1.00	1.00		
Upstream Filter(I)	1.00	1.00	1.00	1.00	0.00	1.00		
Uniform Delay (d), s/veh	23.5	27.8	33.0	8.3	0.0	10.8		
Incr Delay (d2), s/veh	0.5	19.7	70.7	2.3	0.0	7.0		
Initial Q Delay(d3),s/veh	0.0	0.0	0.0	0.0	0.0	0.0		
%ile BackOfQ(50%),veh/ln	2.4	8.6	9.5	8.2	0.0	15.6		
LnGrp Delay(d),s/veh	24.0	47.5	103.7	10.6	0.0	17.8		
LnGrp LOS	C	D	F	B		B		
Approach Vol, veh/h	461			856	854			
Approach Delay, s/veh	40.4			37.0	17.8			
Approach LOS	D			D	B			
Timer	1	2	3	4	5	6	7	8
Assigned Phs		2		4		6		
Phs Duration (G+Y+Rc), s		53.0		24.0		53.0		
Change Period (Y+Rc), s		4.5		4.5		4.5		
Max Green Setting (Gmax), s		48.5		22.5		48.5		
Max Q Clear Time (g_c+I1), s		50.5		18.9		32.1		
Green Ext Time (p_c), s		0.0		0.6		6.0		
Intersection Summary								
HCM 2010 Ctrl Delay			30.2					
HCM 2010 LOS			C					

2: Broadway & 5th Street
 HCM Signalized Intersection Capacity Analysis

03/14/2019



Movement	EBL	EBT	EBR	EBR2	NBT	NBR	NBR2	SBL2	SBL	SBT
Lane Configurations		↕↕	↗	↗	↕↕	↘			↘	↕↕
Traffic Volume (vph)	5	329	791	17	342	50	381	361	144	386
Future Volume (vph)	5	329	791	17	342	50	381	361	144	386
Ideal Flow (vphpl)	1900	1900	1900	1900	1900	1900	1900	1900	1900	1900
Total Lost time (s)		5.5	5.5	5.5	4.5	4.5			4.5	4.5
Lane Util. Factor		0.91	0.91	1.00	0.95	1.00			0.91	0.91
Frbp, ped/bikes		1.00	1.00	0.98	1.00	0.84			1.00	1.00
Flpb, ped/bikes		1.00	1.00	1.00	1.00	1.00			1.00	0.99
Frt		0.92	0.85	0.85	1.00	0.85			1.00	1.00
Flt Protected		1.00	1.00	1.00	1.00	1.00			0.95	0.99
Satd. Flow (prot)		2696	1248	1344	3065	1145			1395	2873
Flt Permitted		1.00	1.00	1.00	1.00	1.00			0.95	0.76
Satd. Flow (perm)		2696	1248	1344	3065	1145			1395	2208
Peak-hour factor, PHF	1.00	1.00	1.00	1.00	1.00	1.00	1.00	1.00	1.00	1.00
Adj. Flow (vph)	5	329	791	17	342	50	381	361	144	386
RTOR Reduction (vph)	0	0	0	11	0	188	0	0	0	0
Lane Group Flow (vph)	0	730	395	6	342	243	0	0	375	516
Confl. Peds. (#/hr)				5		65			65	
Confl. Bikes (#/hr)				1		6				
Heavy Vehicles (%)	6%	6%	6%	6%	6%	6%	6%	6%	6%	6%
Turn Type	Perm	NA	Prot	Perm	NA	Perm		Prot	Prot	NA
Protected Phases		4	4		2			1	1	6
Permitted Phases	4			4		2				
Actuated Green, G (s)		31.0	31.0	31.0	20.5	20.5			24.0	49.0
Effective Green, g (s)		31.0	31.0	31.0	20.5	20.5			24.0	49.0
Actuated g/C Ratio		0.34	0.34	0.34	0.23	0.23			0.27	0.54
Clearance Time (s)		5.5	5.5	5.5	4.5	4.5			4.5	4.5
Vehicle Extension (s)		2.0	2.0	2.0	2.0	2.0			2.0	2.0
Lane Grp Cap (vph)		928	429	462	698	260			372	1379
v/s Ratio Prot			c0.32		0.11				c0.27	0.10
v/s Ratio Perm		0.27		0.00		c0.21				0.10
v/c Ratio		0.88dr	0.92	0.01	0.49	0.93			1.01	0.37
Uniform Delay, d1		26.5	28.3	19.4	30.2	34.1			33.0	11.7
Progression Factor		1.00	1.00	1.00	0.98	0.95			1.00	1.00
Incremental Delay, d2		4.1	24.7	0.0	0.2	37.5			48.7	0.8
Delay (s)		30.6	53.0	19.4	29.7	69.7			81.7	12.5
Level of Service		C	D	B	C	E			F	B
Approach Delay (s)		38.2			52.0					41.6
Approach LOS		D			D					D

Intersection Summary

HCM 2000 Control Delay	43.1	HCM 2000 Level of Service	D
HCM 2000 Volume to Capacity ratio	0.95		
Actuated Cycle Length (s)	90.0	Sum of lost time (s)	14.5
Intersection Capacity Utilization	105.0%	ICU Level of Service	G
Analysis Period (min)	15		

dr Defacto Right Lane. Recode with 1 though lane as a right lane.

c Critical Lane Group

3: 6th Street & Jackson St
 HCM Signalized Intersection Capacity Analysis

03/14/2019























Movement	WBL	WBT	WBR2	NBL2	NBT	SBT	SBR	SER2
Lane Configurations	↶	↷	↷	↶	↷	↷		↷
Traffic Volume (vph)	8	517	84	244	525	189	286	999
Future Volume (vph)	8	517	84	244	525	189	286	999
Ideal Flow (vphpl)	1900	1900	1900	1900	1900	1900	1900	1900
Total Lost time (s)	5.5	5.5	5.5	5.5	5.5	5.5		5.5
Lane Util. Factor	1.00	1.00	1.00	1.00	1.00	1.00		1.00
Frpb, ped/bikes	1.00	1.00	0.99	1.00	1.00	0.98		1.00
Flpb, ped/bikes	1.00	1.00	1.00	1.00	1.00	1.00		1.00
Frt	1.00	1.00	0.85	1.00	1.00	0.92		0.86
Flt Protected	0.95	1.00	1.00	0.95	1.00	1.00		1.00
Satd. Flow (prot)	1601	1693	1420	1605	1693	1527		1450
Flt Permitted	0.95	1.00	1.00	0.39	1.00	1.00		1.00
Satd. Flow (perm)	1601	1693	1420	661	1693	1527		1450
Peak-hour factor, PHF	1.00	1.00	1.00	1.00	1.00	1.00	1.00	0.92
Adj. Flow (vph)	8	517	84	244	525	189	286	1086
RTOR Reduction (vph)	0	0	55	0	0	0	0	0
Lane Group Flow (vph)	8	517	29	244	525	475	0	1086
Confl. Peds. (#/hr)	2			5				5
Confl. Bikes (#/hr)			2					7
Heavy Vehicles (%)	1%	1%	1%	1%	1%	1%	1%	2%
Turn Type	Perm	NA	Perm	Perm	NA	NA		Perm
Protected Phases		8			2	6		
Permitted Phases	8		8	2				6 8
Actuated Green, G (s)	24.5	24.5	24.5	35.5	35.5	35.5		71.0
Effective Green, g (s)	24.5	24.5	24.5	35.5	35.5	35.5		71.0
Actuated g/C Ratio	0.35	0.35	0.35	0.50	0.50	0.50		1.00
Clearance Time (s)	5.5	5.5	5.5	5.5	5.5	5.5		
Vehicle Extension (s)	3.0	3.0	3.0	3.0	3.0	3.0		
Lane Grp Cap (vph)	552	584	490	330	846	763		1450
v/s Ratio Prot		0.31			0.31	0.31		
v/s Ratio Perm	0.00		0.02	0.37				c0.75
v/c Ratio	0.01	0.89	0.06	0.74	0.62	0.62		0.75
Uniform Delay, d1	15.3	21.9	15.5	14.1	12.9	12.9		0.0
Progression Factor	1.00	1.00	1.00	1.00	1.00	1.00		1.00
Incremental Delay, d2	0.0	14.9	0.1	13.8	3.4	3.8		2.2
Delay (s)	15.3	36.8	15.6	27.9	16.3	16.7		2.2
Level of Service	B	D	B	C	B	B		A
Approach Delay (s)		33.6			20.0	16.7		
Approach LOS		C			B	B		

Intersection Summary

HCM 2000 Control Delay	15.7	HCM 2000 Level of Service	B
HCM 2000 Volume to Capacity ratio	0.89		
Actuated Cycle Length (s)	71.0	Sum of lost time (s)	11.0
Intersection Capacity Utilization	163.2%	ICU Level of Service	H
Analysis Period (min)	15		
c Critical Lane Group			





















4: 5th Ave & Embarcadero W
 HCM 2010 Signalized Intersection Summary

03/14/2019

												
Movement	EBL	EBT	EBR	WBL	WBT	WBR	NBL	NBT	NBR	SBL	SBT	SBR
Lane Configurations												
Traffic Volume (veh/h)	33	996	53	61	807	557	29	28	33	1279	56	61
Future Volume (veh/h)	33	996	53	61	807	557	29	28	33	1279	56	61
Number	7	4	14	3	8	18	5	2	12	1	6	16
Initial Q (Qb), veh	0	0	0	0	0	0	0	0	0	0	0	0
Ped-Bike Adj(A_pbT)	1.00		0.96	1.00		0.97	1.00		0.94	1.00		0.97
Parking Bus, Adj	1.00	1.00	1.00	1.00	1.00	1.00	1.00	1.00	1.00	1.00	1.00	1.00
Adj Sat Flow, veh/h/ln	1863	1863	1900	1863	1863	1900	1863	1863	1900	1863	1863	1900
Adj Flow Rate, veh/h	33	996	53	61	807	557	29	28	33	1279	56	61
Adj No. of Lanes	1	2	0	1	2	0	1	1	0	2	1	0
Peak Hour Factor	1.00	1.00	1.00	1.00	1.00	1.00	1.00	1.00	1.00	1.00	1.00	1.00
Percent Heavy Veh, %	2	2	2	2	2	2	2	2	2	2	2	2
Cap, veh/h	79	1478	79	160	865	584	134	57	67	1267	296	323
Arrive On Green	0.29	0.29	0.29	0.43	0.43	0.43	0.08	0.08	0.08	0.37	0.37	0.37
Sat Flow, veh/h	397	3411	181	536	1996	1347	1774	753	887	3442	805	877
Grp Volume(v), veh/h	33	517	532	61	713	651	29	0	61	1279	0	117
Grp Sat Flow(s),veh/h/ln	397	1770	1823	536	1770	1573	1774	0	1640	1721	0	1681
Q Serve(g_s), s	3.7	28.3	28.3	11.7	42.1	43.9	1.7	0.0	3.9	40.5	0.0	5.2
Cycle Q Clear(g_c), s	47.7	28.3	28.3	40.0	42.1	43.9	1.7	0.0	3.9	40.5	0.0	5.2
Prop In Lane	1.00		0.10	1.00		0.86	1.00		0.54	1.00		0.52
Lane Grp Cap(c), veh/h	79	767	790	160	767	682	134	0	124	1267	0	619
V/C Ratio(X)	0.42	0.67	0.67	0.38	0.93	0.95	0.22	0.00	0.49	1.01	0.00	0.19
Avail Cap(c_a), veh/h	79	767	790	160	767	682	290	0	268	1267	0	619
HCM Platoon Ratio	0.67	0.67	0.67	1.00	1.00	1.00	1.00	1.00	1.00	1.00	1.00	1.00
Upstream Filter(I)	0.49	0.49	0.49	0.71	0.71	0.71	1.00	0.00	1.00	1.00	0.00	1.00
Uniform Delay (d), s/veh	62.1	32.2	32.2	42.2	29.6	30.1	47.8	0.0	48.8	34.8	0.0	23.6
Incr Delay (d2), s/veh	7.8	2.3	2.3	4.9	15.0	19.8	0.8	0.0	3.0	27.6	0.0	0.1
Initial Q Delay(d3),s/veh	0.0	0.0	0.0	0.0	0.0	0.0	0.0	0.0	0.0	0.0	0.0	0.0
%ile BackOfQ(50%),veh/ln	1.2	14.4	14.8	1.9	23.6	22.7	0.9	0.0	1.9	24.0	0.0	2.4
LnGrp Delay(d),s/veh	69.9	34.5	34.4	47.0	44.6	49.9	48.6	0.0	51.8	62.3	0.0	23.7
LnGrp LOS	E	C	C	D	D	D	D		D	F		C
Approach Vol, veh/h		1082			1425			90			1396	
Approach Delay, s/veh		35.5			47.1			50.8			59.1	
Approach LOS		D			D			D			E	
Timer	1	2	3	4	5	6	7	8				
Assigned Phs		2		4		6		8				
Phs Duration (G+Y+Rc), s		12.8		52.2		45.0		52.2				
Change Period (Y+Rc), s		4.5		4.5		4.5		4.5				
Max Green Setting (Gmax), s		18.0		38.0		40.5		38.0				
Max Q Clear Time (g_c+I1), s		5.9		49.7		42.5		45.9				
Green Ext Time (p_c), s		0.2		0.0		0.0		0.0				
Intersection Summary												
HCM 2010 Ctrl Delay				48.3								
HCM 2010 LOS				D								























5: 6th Ave/880 Off-Ramp & Embarcadero W
 HCM 2010 Signalized Intersection Summary

03/14/2019

												
Movement	EBL	EBT	EBR	WBL	WBT	WBR	NBL	NBT	NBR	SBL	SBT	SBR
Lane Configurations												
Traffic Volume (veh/h)	0	1912	317	66	772	0	212	0	101	258	123	456
Future Volume (veh/h)	0	1912	317	66	772	0	212	0	101	258	123	456
Number	7	4	14	3	8	18	5	2	12	1	6	16
Initial Q (Qb), veh	0	0	0	0	0	0	0	0	0	0	0	0
Ped-Bike Adj(A_pbT)	1.00		0.81	1.00		1.00	1.00		1.00	1.00		1.00
Parking Bus, Adj	1.00	1.00	1.00	1.00	1.00	1.00	1.00	1.00	1.00	1.00	1.00	1.00
Adj Sat Flow, veh/h/ln	0	1863	1900	1863	1863	0	1863	0	1863	1863	1863	1863
Adj Flow Rate, veh/h	0	1912	317	66	772	0	212	0	15	258	123	352
Adj No. of Lanes	0	2	0	1	2	0	1	0	1	1	1	1
Peak Hour Factor	1.00	1.00	1.00	1.00	1.00	1.00	1.00	1.00	1.00	1.00	1.00	1.00
Percent Heavy Veh, %	0	2	2	2	2	0	2	0	2	2	2	2
Cap, veh/h	0	2004	310	65	2391	0	0	0	0	430	452	384
Arrive On Green	0.00	0.45	0.45	0.90	0.90	0.00	0.00	0.00	0.00	0.24	0.24	0.24
Sat Flow, veh/h	0	3059	459	171	3632	0		0		1774	1863	1583
Grp Volume(v), veh/h	0	1086	1143	66	772	0		0.0		258	123	352
Grp Sat Flow(s),veh/h/ln	0	1770	1655	171	1770	0				1774	1863	1583
Q Serve(g_s), s	0.0	62.7	74.3	0.0	3.4	0.0				14.2	5.9	23.8
Cycle Q Clear(g_c), s	0.0	62.7	74.3	74.3	3.4	0.0				14.2	5.9	23.8
Prop In Lane	0.00		0.28	1.00		0.00				1.00		1.00
Lane Grp Cap(c), veh/h	0	1196	1118	65	2391	0				430	452	384
V/C Ratio(X)	0.00	0.91	1.02	1.01	0.32	0.00				0.60	0.27	0.92
Avail Cap(c_a), veh/h	0	1196	1118	65	2391	0				460	483	410
HCM Platoon Ratio	1.00	0.67	0.67	1.33	1.33	1.00				1.00	1.00	1.00
Upstream Filter(I)	0.00	0.46	0.46	0.88	0.88	0.00				1.00	1.00	1.00
Uniform Delay (d), s/veh	0.0	26.9	30.1	42.7	2.0	0.0				36.9	33.8	40.6
Incr Delay (d2), s/veh	0.0	6.0	24.2	106.9	0.3	0.0				1.9	0.3	24.3
Initial Q Delay(d3),s/veh	0.0	0.0	0.0	0.0	0.0	0.0				0.0	0.0	0.0
%ile BackOfQ(50%),veh/ln	0.0	32.6	41.5	3.9	1.6	0.0				7.2	3.1	13.0
LnGrp Delay(d),s/veh	0.0	32.9	54.3	149.7	2.3	0.0				38.9	34.1	64.9
LnGrp LOS		C	F	F	A					D	C	E
Approach Vol, veh/h		2229			838						733	
Approach Delay, s/veh		43.9			13.9						50.6	
Approach LOS		D			B						D	
Timer	1	2	3	4	5	6	7	8				
Assigned Phs				4		6		8				
Phs Duration (G+Y+Rc), s				78.8		31.2		78.8				
Change Period (Y+Rc), s				4.5		4.5		4.5				
Max Green Setting (Gmax), s				50.0		28.5		50.0				
Max Q Clear Time (g_c+I1), s				76.3		25.8		76.3				
Green Ext Time (p_c), s				0.0		0.9		0.0				
Intersection Summary												
HCM 2010 Ctrl Delay			38.6									
HCM 2010 LOS			D									

















6: Webster St & Atlantic Ave
 HCM 2010 Signalized Intersection Summary

03/14/2019

												
Movement	EBL	EBT	EBR	WBL	WBT	WBR	NBL	NBT	NBR	SBL	SBT	SBR
Lane Configurations												
Traffic Volume (veh/h)	178	336	152	60	259	105	110	449	57	173	797	298
Future Volume (veh/h)	178	336	152	60	259	105	110	449	57	173	797	298
Number	7	4	14	3	8	18	5	2	12	1	6	16
Initial Q (Qb), veh	0	0	0	0	0	0	0	0	0	0	0	0
Ped-Bike Adj(A_pbT)	1.00		0.93	1.00		0.93	1.00		0.95	1.00		0.95
Parking Bus, Adj	1.00	1.00	1.00	1.00	1.00	1.00	1.00	1.00	1.00	1.00	1.00	1.00
Adj Sat Flow, veh/h/ln	1863	1863	1863	1863	1863	1900	1863	1863	1900	1863	1863	1863
Adj Flow Rate, veh/h	180	339	32	61	262	106	111	454	58	175	805	109
Adj No. of Lanes	2	2	1	1	2	0	2	2	0	1	2	1
Peak Hour Factor	0.99	0.99	0.99	0.99	0.99	0.99	0.99	0.99	0.99	0.99	0.99	0.99
Percent Heavy Veh, %	2	2	2	2	2	2	2	2	2	2	2	2
Cap, veh/h	682	701	292	367	504	196	181	810	103	218	1161	494
Arrive On Green	0.20	0.20	0.20	0.21	0.21	0.21	0.05	0.26	0.26	0.12	0.33	0.33
Sat Flow, veh/h	3442	3539	1474	1774	2437	949	3442	3138	398	1774	3539	1504
Grp Volume(v), veh/h	180	339	32	61	188	180	111	255	257	175	805	109
Grp Sat Flow(s),veh/h/ln	1721	1770	1474	1774	1770	1616	1721	1770	1767	1774	1770	1504
Q Serve(g_s), s	3.5	6.7	1.4	2.2	7.5	7.9	2.5	9.9	10.0	7.6	15.7	4.2
Cycle Q Clear(g_c), s	3.5	6.7	1.4	2.2	7.5	7.9	2.5	9.9	10.0	7.6	15.7	4.2
Prop In Lane	1.00		1.00	1.00		0.59	1.00		0.23	1.00		1.00
Lane Grp Cap(c), veh/h	682	701	292	367	366	334	181	457	456	218	1161	494
V/C Ratio(X)	0.26	0.48	0.11	0.17	0.51	0.54	0.61	0.56	0.56	0.80	0.69	0.22
Avail Cap(c_a), veh/h	1085	1116	465	559	558	510	304	580	580	448	1741	740
HCM Platoon Ratio	1.00	1.00	1.00	1.00	1.00	1.00	1.00	1.00	1.00	1.00	1.00	1.00
Upstream Filter(I)	1.00	1.00	1.00	1.00	1.00	1.00	1.00	1.00	1.00	1.00	1.00	1.00
Uniform Delay (d), s/veh	26.9	28.2	26.1	25.8	27.9	28.1	36.8	25.5	25.5	33.8	23.2	19.3
Incr Delay (d2), s/veh	0.2	0.5	0.2	0.2	1.1	1.4	3.3	1.1	1.1	6.8	0.8	0.2
Initial Q Delay(d3),s/veh	0.0	0.0	0.0	0.0	0.0	0.0	0.0	0.0	0.0	0.0	0.0	0.0
%ile BackOfQ(50%),veh/ln	1.7	3.3	0.6	1.1	3.8	3.6	1.3	4.9	5.0	4.2	7.7	1.8
LnGrp Delay(d),s/veh	27.1	28.7	26.2	26.0	29.0	29.4	40.1	26.6	26.6	40.6	23.9	19.5
LnGrp LOS	C	C	C	C	C	C	D	C	C	D	C	B
Approach Vol, veh/h		551			429			623			1089	
Approach Delay, s/veh		28.0			28.8			29.0			26.2	
Approach LOS		C			C			C			C	
Timer	1	2	3	4	5	6	7	8				
Assigned Phs	1	2		4	5	6		8				
Phs Duration (G+Y+Rc), s	13.7	25.5		19.7	8.2	31.0		20.4				
Change Period (Y+Rc), s	4.0	5.0		4.0	4.0	5.0		4.0				
Max Green Setting (Gmax), s	20.0	26.0		25.0	7.0	39.0		25.0				
Max Q Clear Time (g_c+I1), s	9.6	12.0		8.7	4.5	17.7		9.9				
Green Ext Time (p_c), s	0.3	2.8		2.8	0.1	6.5		2.2				
Intersection Summary												
HCM 2010 Ctrl Delay				27.6								
HCM 2010 LOS				C								

















7: Broadway & Embarcadero W
 HCM 2010 Signalized Intersection Summary

03/14/2019

												
Movement	EBL	EBT	EBR	WBL	WBT	WBR	NBL	NBT	NBR	SBL	SBT	SBR
Lane Configurations												
Traffic Volume (veh/h)	24	150	45	99	39	203	13	62	140	221	78	34
Future Volume (veh/h)	24	150	45	99	39	203	13	62	140	221	78	34
Number	7	4	14	3	8	18	5	2	12	1	6	16
Initial Q (Qb), veh	0	0	0	0	0	0	0	0	0	0	0	0
Ped-Bike Adj(A_pbT)	0.98		0.96	0.98		0.96	0.90		0.85	0.92		0.85
Parking Bus, Adj	1.00	1.00	1.00	1.00	1.00	1.00	1.00	1.00	1.00	1.00	1.00	1.00
Adj Sat Flow, veh/h/ln	1710	1660	1710	1710	1660	1710	1710	1660	1710	1710	1660	1710
Adj Flow Rate, veh/h	24	150	45	99	39	203	13	62	140	221	78	34
Adj No. of Lanes	0	1	0	0	1	0	0	1	0	0	2	0
Peak Hour Factor	1.00	1.00	1.00	1.00	1.00	1.00	1.00	1.00	1.00	1.00	1.00	1.00
Percent Heavy Veh, %	3	3	3	3	3	3	3	3	3	3	3	3
Cap, veh/h	118	460	127	212	104	313	96	173	344	557	377	164
Arrive On Green	0.40	0.40	0.40	0.40	0.40	0.40	0.40	0.40	0.40	0.40	0.40	0.40
Sat Flow, veh/h	72	1151	316	272	260	783	27	433	859	993	943	411
Grp Volume(v), veh/h	219	0	0	341	0	0	215	0	0	221	0	112
Grp Sat Flow(s),veh/h/ln	1539	0	0	1315	0	0	1319	0	0	993	0	1354
Q Serve(g_s), s	0.0	0.0	0.0	4.3	0.0	0.0	0.0	0.0	0.0	2.1	0.0	2.4
Cycle Q Clear(g_c), s	4.3	0.0	0.0	9.0	0.0	0.0	5.2	0.0	0.0	7.3	0.0	2.4
Prop In Lane	0.11		0.21	0.29		0.60	0.06		0.65	1.00		0.30
Lane Grp Cap(c), veh/h	704	0	0	629	0	0	612	0	0	557	0	541
V/C Ratio(X)	0.31	0.00	0.00	0.54	0.00	0.00	0.35	0.00	0.00	0.40	0.00	0.21
Avail Cap(c_a), veh/h	704	0	0	629	0	0	612	0	0	557	0	541
HCM Platoon Ratio	1.00	1.00	1.00	1.00	1.00	1.00	1.00	1.00	1.00	1.00	1.00	1.00
Upstream Filter(I)	1.00	0.00	0.00	1.00	0.00	0.00	1.00	0.00	0.00	1.00	0.00	1.00
Uniform Delay (d), s/veh	9.4	0.0	0.0	10.7	0.0	0.0	9.7	0.0	0.0	10.2	0.0	8.8
Incr Delay (d2), s/veh	1.1	0.0	0.0	3.3	0.0	0.0	1.6	0.0	0.0	2.1	0.0	0.9
Initial Q Delay(d3),s/veh	0.0	0.0	0.0	0.0	0.0	0.0	0.0	0.0	0.0	0.0	0.0	0.0
%ile BackOfQ(50%),veh/ln	2.1	0.0	0.0	3.9	0.0	0.0	2.2	0.0	0.0	2.4	0.0	1.0
LnGrp Delay(d),s/veh	10.5	0.0	0.0	14.0	0.0	0.0	11.2	0.0	0.0	12.3	0.0	9.7
LnGrp LOS	B			B			B			B		A
Approach Vol, veh/h		219			341			215				333
Approach Delay, s/veh		10.5			14.0			11.2				11.4
Approach LOS		B			B			B				B
Timer	1	2	3	4	5	6	7	8				
Assigned Phs		2		4		6		8				
Phs Duration (G+Y+Rc), s		22.5		22.5		22.5		22.5				
Change Period (Y+Rc), s		4.5		4.5		4.5		4.5				
Max Green Setting (Gmax), s		18.0		18.0		18.0		18.0				
Max Q Clear Time (g_c+I1), s		7.2		6.3		9.3		11.0				
Green Ext Time (p_c), s		1.0		0.9		1.4		1.3				
Intersection Summary												
HCM 2010 Ctrl Delay				12.0								
HCM 2010 LOS				B								





























8: Oak St & 5th Street
 HCM 2010 Signalized Intersection Summary

03/14/2019

												
Movement	EBL	EBT	EBR	WBL	WBT	WBR	NBL	NBT	NBR	SBL	SBT	SBR
Lane Configurations												
Traffic Volume (veh/h)	421	801	378	0	0	0	0	462	194	3	19	0
Future Volume (veh/h)	421	801	378	0	0	0	0	462	194	3	19	0
Number	7	4	14				5	2	12	1	6	16
Initial Q (Qb), veh	0	0	0				0	0	0	0	0	0
Ped-Bike Adj(A_pbT)	1.00		0.98				1.00		0.95	1.00		1.00
Parking Bus, Adj	1.00	1.00	1.00				1.00	1.00	1.00	1.00	1.00	1.00
Adj Sat Flow, veh/h/ln	1660	1660	1710				0	1660	1710	1710	1660	0
Adj Flow Rate, veh/h	421	801	378				0	462	194	3	19	0
Adj No. of Lanes	1	2	0				0	1	0	0	1	0
Peak Hour Factor	1.00	1.00	1.00				1.00	1.00	1.00	1.00	1.00	1.00
Percent Heavy Veh, %	3	3	3				0	3	3	3	3	0
Cap, veh/h	740	968	455				0	492	206	46	243	0
Arrive On Green	0.47	0.47	0.47				0.00	0.45	0.45	0.45	0.45	0.00
Sat Flow, veh/h	1581	2067	971				0	1093	459	20	539	0
Grp Volume(v), veh/h	421	610	569				0	0	656	22	0	0
Grp Sat Flow(s),veh/h/ln	1581	1577	1461				0	0	1551	559	0	0
Q Serve(g_s), s	21.2	36.9	37.3				0.0	0.0	44.3	0.5	0.0	0.0
Cycle Q Clear(g_c), s	21.2	36.9	37.3				0.0	0.0	44.3	44.8	0.0	0.0
Prop In Lane	1.00		0.66				0.00		0.30	0.14		0.00
Lane Grp Cap(c), veh/h	740	738	684				0	0	698	289	0	0
V/C Ratio(X)	0.57	0.83	0.83				0.00	0.00	0.94	0.08	0.00	0.00
Avail Cap(c_a), veh/h	740	738	684				0	0	698	289	0	0
HCM Platoon Ratio	1.00	1.00	1.00				1.00	1.00	1.00	1.00	1.00	1.00
Upstream Filter(I)	1.00	1.00	1.00				0.00	0.00	1.00	1.00	0.00	0.00
Uniform Delay (d), s/veh	21.2	25.4	25.5				0.0	0.0	28.8	21.6	0.0	0.0
Incr Delay (d2), s/veh	3.2	10.3	11.3				0.0	0.0	22.1	0.5	0.0	0.0
Initial Q Delay(d3),s/veh	0.0	0.0	0.0				0.0	0.0	0.0	0.0	0.0	0.0
%ile BackOfQ(50%),veh/ln	9.9	18.0	17.1				0.0	0.0	23.2	0.4	0.0	0.0
LnGrp Delay(d),s/veh	24.4	35.7	36.7				0.0	0.0	50.9	22.1	0.0	0.0
LnGrp LOS	C	D	D						D	C		
Approach Vol, veh/h		1600						656			22	
Approach Delay, s/veh		33.1						50.9			22.1	
Approach LOS		C						D			C	
Timer	1	2	3	4	5	6	7	8				
Assigned Phs		2		4		6						
Phs Duration (G+Y+Rc), s		54.0		56.0		54.0						
Change Period (Y+Rc), s		4.5		4.5		4.5						
Max Green Setting (Gmax), s		49.5		51.5		49.5						
Max Q Clear Time (g_c+I1), s		46.3		39.3		46.8						
Green Ext Time (p_c), s		1.0		5.2		0.0						
Intersection Summary												
HCM 2010 Ctrl Delay			38.1									
HCM 2010 LOS			D									













9: Harrison St & Grand Ave
 HCM 2010 Signalized Intersection Summary

03/14/2019

												
Movement	EBL	EBT	EBR	WBL	WBT	WBR	NBL	NBT	NBR	SBL	SBT	SBR
Lane Configurations	 	 		 	 			  			 	
Traffic Volume (veh/h)	162	790	78	173	294	25	0	890	609	0	406	108
Future Volume (veh/h)	162	790	78	173	294	25	0	890	609	0	406	108
Number	3	8	18	7	4	14	5	2	12	1	6	16
Initial Q (Qb), veh	0	0	0	0	0	0	0	0	0	0	0	0
Ped-Bike Adj(A_pbT)	1.00		0.72	1.00		0.89	1.00		1.00	1.00		0.82
Parking Bus, Adj	1.00	1.00	1.00	1.00	1.00	1.00	1.00	1.00	1.00	1.00	1.00	1.00
Adj Sat Flow, veh/h/ln	1881	1881	1881	1881	1881	1900	0	1881	1881	0	1881	1881
Adj Flow Rate, veh/h	162	790	25	173	294	25	0	890	0	0	406	51
Adj No. of Lanes	2	2	1	2	2	0	0	3	1	0	2	1
Peak Hour Factor	1.00	1.00	1.00	1.00	1.00	1.00	1.00	1.00	1.00	1.00	1.00	1.00
Percent Heavy Veh, %	1	1	1	1	1	1	0	1	1	0	1	1
Cap, veh/h	225	1085	347	1006	1792	151	0	1305	406	0	908	332
Arrive On Green	0.06	0.30	0.30	0.29	0.54	0.54	0.00	0.25	0.00	0.00	0.25	0.25
Sat Flow, veh/h	3476	3574	1144	3476	3300	277	0	5305	1599	0	3668	1308
Grp Volume(v), veh/h	162	790	25	173	158	161	0	890	0	0	406	51
Grp Sat Flow(s),veh/h/ln	1738	1787	1144	1738	1787	1790	0	1712	1599	0	1787	1308
Q Serve(g_s), s	5.0	21.7	1.7	4.1	4.9	5.0	0.0	17.2	0.0	0.0	10.5	3.3
Cycle Q Clear(g_c), s	5.0	21.7	1.7	4.1	4.9	5.0	0.0	17.2	0.0	0.0	10.5	3.3
Prop In Lane	1.00		1.00	1.00		0.15	0.00		1.00	0.00		1.00
Lane Grp Cap(c), veh/h	225	1085	347	1006	971	972	0	1305	406	0	908	332
V/C Ratio(X)	0.72	0.73	0.07	0.17	0.16	0.17	0.00	0.68	0.00	0.00	0.45	0.15
Avail Cap(c_a), veh/h	316	1085	347	1006	971	972	0	2540	791	0	1768	647
HCM Platoon Ratio	1.00	1.00	1.00	1.00	1.00	1.00	1.00	1.00	1.00	1.00	1.00	1.00
Upstream Filter(I)	1.00	1.00	1.00	1.00	1.00	1.00	0.00	1.00	0.00	0.00	1.00	1.00
Uniform Delay (d), s/veh	50.5	34.2	27.3	29.2	12.6	12.6	0.0	37.0	0.0	0.0	34.5	31.8
Incr Delay (d2), s/veh	4.7	4.3	0.4	0.1	0.4	0.4	0.0	0.6	0.0	0.0	0.3	0.2
Initial Q Delay(d3),s/veh	0.0	0.0	0.0	0.0	0.0	0.0	0.0	0.0	0.0	0.0	0.0	0.0
%ile BackOfQ(50%),veh/ln	2.6	11.4	0.6	2.0	2.5	2.6	0.0	8.2	0.0	0.0	5.2	1.2
LnGrp Delay(d),s/veh	55.2	38.5	27.7	29.3	13.0	13.0	0.0	37.7	0.0	0.0	34.9	32.1
LnGrp LOS	E	D	C	C	B	B		D			C	C
Approach Vol, veh/h		977			492			890			457	
Approach Delay, s/veh		41.0			18.7			37.7			34.6	
Approach LOS		D			B			D			C	
Timer	1	2	3	4	5	6	7	8				
Assigned Phs		2	3	4		6	7	8				
Phs Duration (G+Y+Rc), s		33.6	11.1	65.3		33.6	37.4	39.0				
Change Period (Y+Rc), s		5.6	4.0	5.6		5.6	5.6	* 5.6				
Max Green Setting (Gmax), s		54.4	10.0	30.4		54.4	7.0	* 33				
Max Q Clear Time (g_c+I1), s		19.2	7.0	7.0		12.5	6.1	23.7				
Green Ext Time (p_c), s		7.5	0.1	1.8		3.2	0.0	3.9				
Intersection Summary												
HCM 2010 Ctrl Delay			35.0									
HCM 2010 LOS			D									
Notes												



















10: Lakeshore Ave & Foothill Blvd
 HCM 2010 Signalized Intersection Summary

03/14/2019

								
Movement	WBL	WBR	NBT	NBR	SBL	SBT		
Lane Configurations	 		 			 		
Traffic Volume (veh/h)	111	111	1187	0	0	726		
Future Volume (veh/h)	111	111	1187	0	0	726		
Number	3	18	2	12	1	6		
Initial Q (Qb), veh	0	0	0	0	0	0		
Ped-Bike Adj(A_pbT)	1.00	1.00		1.00	1.00			
Parking Bus, Adj	1.00	1.00	1.00	1.00	1.00	1.00		
Adj Sat Flow, veh/h/ln	1863	1900	1863	0	0	1863		
Adj Flow Rate, veh/h	111	111	1187	0	0	726		
Adj No. of Lanes	1	1	2	0	0	2		
Peak Hour Factor	1.00	1.00	1.00	1.00	1.00	1.00		
Percent Heavy Veh, %	2	0	2	0	0	2		
Cap, veh/h	157	142	3002	0	0	3002		
Arrive On Green	0.09	0.09	0.85	0.00	0.00	0.85		
Sat Flow, veh/h	1774	1615	3725	0	0	3725		
Grp Volume(v), veh/h	111	111	1187	0	0	726		
Grp Sat Flow(s),veh/h/ln	1774	1615	1770	0	0	1770		
Q Serve(g_s), s	6.7	7.4	8.4	0.0	0.0	4.3		
Cycle Q Clear(g_c), s	6.7	7.4	8.4	0.0	0.0	4.3		
Prop In Lane	1.00	1.00		0.00	0.00			
Lane Grp Cap(c), veh/h	157	142	3002	0	0	3002		
V/C Ratio(X)	0.71	0.78	0.40	0.00	0.00	0.24		
Avail Cap(c_a), veh/h	476	433	3002	0	0	3002		
HCM Platoon Ratio	1.00	1.00	1.00	1.00	1.00	1.00		
Upstream Filter(I)	1.00	1.00	1.00	0.00	0.00	1.00		
Uniform Delay (d), s/veh	48.8	49.1	1.9	0.0	0.0	1.6		
Incr Delay (d2), s/veh	2.2	3.5	0.4	0.0	0.0	0.2		
Initial Q Delay(d3),s/veh	0.0	0.0	0.0	0.0	0.0	0.0		
%ile BackOfQ(50%),veh/ln	3.4	3.4	4.1	0.0	0.0	2.1		
LnGrp Delay(d),s/veh	51.0	52.6	2.3	0.0	0.0	1.8		
LnGrp LOS	D	D	A			A		
Approach Vol, veh/h	222		1187			726		
Approach Delay, s/veh	51.8		2.3			1.8		
Approach LOS	D		A			A		
Timer	1	2	3	4	5	6	7	8
Assigned Phs		2				6		8
Phs Duration (G+Y+Rc), s		96.8				96.8		13.2
Change Period (Y+Rc), s		3.5				3.5		3.5
Max Green Setting (Gmax), s		73.5				73.5		29.5
Max Q Clear Time (g_c+I1), s		10.4				6.3		9.4
Green Ext Time (p_c), s		8.1				4.1		0.3
Intersection Summary								
HCM 2010 Ctrl Delay			7.3					
HCM 2010 LOS			A					
Notes								





















11: Lakeshore Ave & MacArthur Blvd
 HCM 2010 Signalized Intersection Summary

03/14/2019

												
Movement	EBL	EBT	EBR	WBL	WBT	WBR	NBL	NBT	NBR	SBL	SBT	SBR
Lane Configurations												
Traffic Volume (veh/h)	209	1237	111	0	0	0	0	445	423	296	440	0
Future Volume (veh/h)	209	1237	111	0	0	0	0	445	423	296	440	0
Number	7	4	14				5	2	12	1	6	16
Initial Q (Qb), veh	0	0	0				0	0	0	0	0	0
Ped-Bike Adj(A_pbT)	1.00		0.94				1.00		0.92	1.00		1.00
Parking Bus, Adj	1.00	1.00	1.00				1.00	1.00	1.00	1.00	1.00	1.00
Adj Sat Flow, veh/h/ln	1881	1881	1881				0	1881	1900	1881	1881	0
Adj Flow Rate, veh/h	209	1237	77				0	445	423	296	440	0
Adj No. of Lanes	1	3	1				0	2	0	1	2	0
Peak Hour Factor	1.00	1.00	1.00				1.00	1.00	1.00	1.00	1.00	1.00
Percent Heavy Veh, %	1	1	1				0	1	1	1	1	0
Cap, veh/h	501	1578	422				0	590	488	479	2271	0
Arrive On Green	0.28	0.28	0.28				0.00	0.33	0.33	0.54	1.00	0.00
Sat Flow, veh/h	1792	5644	1510				0	1881	1478	1792	3668	0
Grp Volume(v), veh/h	209	1237	77				0	445	423	296	440	0
Grp Sat Flow(s),veh/h/ln	1792	1881	1510				0	1787	1478	1792	1787	0
Q Serve(g_s), s	10.1	21.4	4.1				0.0	23.5	28.5	12.2	0.0	0.0
Cycle Q Clear(g_c), s	10.1	21.4	4.1				0.0	23.5	28.5	12.2	0.0	0.0
Prop In Lane	1.00		1.00				0.00		1.00	1.00		0.00
Lane Grp Cap(c), veh/h	501	1578	422				0	590	488	479	2271	0
V/C Ratio(X)	0.42	0.78	0.18				0.00	0.75	0.87	0.62	0.19	0.00
Avail Cap(c_a), veh/h	659	2076	556				0	590	488	479	2271	0
HCM Platoon Ratio	1.00	1.00	1.00				1.00	1.00	1.00	2.00	2.00	1.00
Upstream Filter(I)	1.00	1.00	1.00				0.00	1.00	1.00	0.82	0.82	0.00
Uniform Delay (d), s/veh	31.1	35.2	29.0				0.0	31.7	33.3	20.9	0.0	0.0
Incr Delay (d2), s/veh	0.2	1.0	0.1				0.0	8.7	18.3	1.5	0.2	0.0
Initial Q Delay(d3),s/veh	0.0	0.0	0.0				0.0	0.0	0.0	0.0	0.0	0.0
%ile BackOfQ(50%),veh/ln	5.0	11.3	1.7				0.0	13.0	14.1	6.1	0.0	0.0
LnGrp Delay(d),s/veh	31.3	36.3	29.1				0.0	40.3	51.6	22.3	0.2	0.0
LnGrp LOS	C	D	C					D	D	C	A	
Approach Vol, veh/h		1523						868			736	
Approach Delay, s/veh		35.2						45.8			9.1	
Approach LOS		D						D			A	
Timer	1	2	3	4	5	6	7	8				
Assigned Phs	1	2		4		6						
Phs Duration (G+Y+Rc), s	32.4	39.0		34.6		71.4						
Change Period (Y+Rc), s	4.0	* 4		5.0		4.0						
Max Green Setting (Gmax), s	19.5	* 35		39.0		58.0						
Max Q Clear Time (g_c+I1), s	14.2	30.5		23.4		2.0						
Green Ext Time (p_c), s	0.2	1.9		6.2		2.3						
Intersection Summary												
HCM 2010 Ctrl Delay			32.0									
HCM 2010 LOS			C									
Notes												

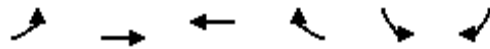
12: Lakeshore Ave & Lake Park Ave
 HCM 2010 Signalized Intersection Summary

03/14/2019

												
Movement	EBL	EBT	EBR	WBL	WBT	WBR	NBL	NBT	NBR	SBL	SBT	SBR
Lane Configurations												
Traffic Volume (veh/h)	140	0	132	300	399	266	219	416	0	0	315	160
Future Volume (veh/h)	140	0	132	300	399	266	219	416	0	0	315	160
Number	7	4	14	3	8	18	5	2	12	1	6	16
Initial Q (Qb), veh	0	0	0	0	0	0	0	0	0	0	0	0
Ped-Bike Adj(A_pbT)	1.00		0.99	1.00		1.00	1.00		1.00	1.00		0.83
Parking Bus, Adj	1.00	1.00	1.00	1.00	1.00	1.00	1.00	1.00	1.00	1.00	1.00	1.00
Adj Sat Flow, veh/h/ln	1881	1881	1900	1900	1881	1881	1881	1881	0	0	1881	1900
Adj Flow Rate, veh/h	136	6	132	300	399	0	219	416	0	0	315	160
Adj No. of Lanes	1	1	0	0	2	1	2	1	0	0	2	0
Peak Hour Factor	1.00	1.00	1.00	1.00	1.00	1.00	1.00	1.00	1.00	1.00	1.00	1.00
Percent Heavy Veh, %	1	1	1	1	1	1	1	1	0	0	1	1
Cap, veh/h	190	7	161	592	590	528	450	794	0	0	545	263
Arrive On Green	0.11	0.11	0.11	0.33	0.33	0.00	0.26	0.84	0.00	0.00	0.25	0.25
Sat Flow, veh/h	1792	69	1519	1792	1787	1599	3476	1881	0	0	2273	1052
Grp Volume(v), veh/h	136	0	138	300	399	0	219	416	0	0	255	220
Grp Sat Flow(s),veh/h/ln	1792	0	1588	1792	1787	1599	1738	1881	0	0	1787	1444
Q Serve(g_s), s	7.8	0.0	9.0	14.3	20.4	0.0	5.7	6.6	0.0	0.0	13.3	14.3
Cycle Q Clear(g_c), s	7.8	0.0	9.0	14.3	20.4	0.0	5.7	6.6	0.0	0.0	13.3	14.3
Prop In Lane	1.00		0.96	1.00		1.00	1.00		0.00	0.00		0.73
Lane Grp Cap(c), veh/h	190	0	169	592	590	528	450	794	0	0	447	361
V/C Ratio(X)	0.71	0.00	0.82	0.51	0.68	0.00	0.49	0.52	0.00	0.00	0.57	0.61
Avail Cap(c_a), veh/h	245	0	217	592	590	528	450	794	0	0	447	361
HCM Platoon Ratio	1.00	1.00	1.00	1.00	1.00	1.00	2.00	2.00	1.00	1.00	1.00	1.00
Upstream Filter(I)	1.00	0.00	1.00	1.00	1.00	0.00	0.68	0.68	0.00	0.00	1.00	1.00
Uniform Delay (d), s/veh	45.8	0.0	46.4	28.6	30.6	0.0	36.3	5.3	0.0	0.0	34.8	35.2
Incr Delay (d2), s/veh	4.1	0.0	13.5	3.1	6.1	0.0	0.2	1.7	0.0	0.0	5.2	7.4
Initial Q Delay(d3),s/veh	0.0	0.0	0.0	0.0	0.0	0.0	0.0	0.0	0.0	0.0	0.0	0.0
%ile BackOfQ(50%),veh/ln	4.1	0.0	4.6	7.6	11.1	0.0	2.7	3.6	0.0	0.0	7.2	6.4
LnGrp Delay(d),s/veh	49.9	0.0	59.9	31.6	36.7	0.0	36.5	7.0	0.0	0.0	40.0	42.6
LnGrp LOS	D		E	C	D		D	A			D	D
Approach Vol, veh/h		274			699			635			475	
Approach Delay, s/veh		54.9			34.5			17.2			41.2	
Approach LOS		D			C			B			D	
Timer	1	2	3	4	5	6	7	8				
Assigned Phs		2		4	5	6		8				
Phs Duration (G+Y+Rc), s		49.2		16.8	18.2	31.0		40.0				
Change Period (Y+Rc), s		4.5		5.5	4.5	* 4.5		5.0				
Max Green Setting (Gmax), s		41.5		14.5	11.0	* 27		35.0				
Max Q Clear Time (g_c+I1), s		8.6		11.0	7.7	16.3		22.4				
Green Ext Time (p_c), s		1.9		0.3	0.1	1.6		2.4				
Intersection Summary												
HCM 2010 Ctrl Delay			33.4									
HCM 2010 LOS			C									
Notes												

13: Embarcadero W & 880 On-Ramp
 HCM 2010 Signalized Intersection Summary
























03/14/2019



Movement	EBL	EBT	WBT	WBR	SBL	SBR		
Lane Configurations								
Traffic Volume (veh/h)	996	838	537	102	0	0		
Future Volume (veh/h)	996	838	537	102	0	0		
Number	7	4	8	18				
Initial Q (Qb), veh	0	0	0	0				
Ped-Bike Adj(A_pbT)	1.00			1.00				
Parking Bus, Adj	1.00	1.00	1.00	1.00				
Adj Sat Flow, veh/h/ln	1863	1863	1863	1900				
Adj Flow Rate, veh/h	996	838	537	0				
Adj No. of Lanes	1	2	1	0				
Peak Hour Factor	1.00	1.00	1.00	1.00				
Percent Heavy Veh, %	2	2	2	2				
Cap, veh/h	998	3394	662	0				
Arrive On Green	0.94	1.00	0.36	0.00				
Sat Flow, veh/h	1774	3632	1863	0				
Grp Volume(v), veh/h	996	838	537	0				
Grp Sat Flow(s),veh/h/ln	1774	1770	1863	0				
Q Serve(g_s), s	59.8	0.0	28.7	0.0				
Cycle Q Clear(g_c), s	59.8	0.0	28.7	0.0				
Prop In Lane	1.00			0.00				
Lane Grp Cap(c), veh/h	998	3394	662	0				
V/C Ratio(X)	1.00	0.25	0.81	0.00				
Avail Cap(c_a), veh/h	998	3394	662	0				
HCM Platoon Ratio	1.67	1.67	1.00	1.00				
Upstream Filter(I)	1.00	1.00	1.00	0.00				
Uniform Delay (d), s/veh	3.3	0.0	32.1	0.0				
Incr Delay (d2), s/veh	27.9	0.2	10.4	0.0				
Initial Q Delay(d3),s/veh	0.0	0.0	0.0	0.0				
%ile BackOfQ(50%),veh/ln	30.3	0.1	16.7	0.0				
LnGrp Delay(d),s/veh	31.2	0.2	42.5	0.0				
LnGrp LOS	C	A	D					
Approach Vol, veh/h		1834	537					
Approach Delay, s/veh		17.0	42.5					
Approach LOS		B	D					
Timer	1	2	3	4	5	6	7	8
Assigned Phs				4			7	8
Phs Duration (G+Y+Rc), s				110.0			66.4	43.6
Change Period (Y+Rc), s				4.5			4.5	4.5
Max Green Setting (Gmax), s				105.5			61.9	39.1
Max Q Clear Time (g_c+I1), s				2.0			61.8	30.7
Green Ext Time (p_c), s				7.4			0.1	2.2
Intersection Summary								
HCM 2010 Ctrl Delay			22.8					
HCM 2010 LOS			C					



















14: 5th Ave & E 8th St
 HCM 2010 Signalized Intersection Summary

03/14/2019

												
Movement	EBL	EBT	EBR	WBL	WBT	WBR	NBL	NBT	NBR	SBL	SBT	SBR
Lane Configurations												
Traffic Volume (veh/h)	156	832	491	172	214	2	140	401	140	42	641	61
Future Volume (veh/h)	156	832	491	172	214	2	140	401	140	42	641	61
Number	7	4	14	3	8	18	5	2	12	1	6	16
Initial Q (Qb), veh	0	0	0	0	0	0	0	0	0	0	0	0
Ped-Bike Adj(A_pbT)	0.99		0.96	1.00		0.97	1.00		0.98	1.00		0.98
Parking Bus, Adj	1.00	1.00	1.00	1.00	1.00	1.00	1.00	1.00	1.00	1.00	1.00	1.00
Adj Sat Flow, veh/h/ln	1863	1863	1863	1863	1863	1900	1863	1863	1863	1863	1863	1863
Adj Flow Rate, veh/h	156	832	395	172	214	2	140	401	97	42	641	35
Adj No. of Lanes	1	3	1	1	2	0	1	1	1	1	1	1
Peak Hour Factor	1.00	1.00	1.00	1.00	1.00	1.00	1.00	1.00	1.00	1.00	1.00	1.00
Percent Heavy Veh, %	2	2	2	2	2	2	2	2	2	2	2	2
Cap, veh/h	566	2191	657	255	1547	14	247	860	717	391	860	717
Arrive On Green	0.43	0.43	0.43	0.43	0.43	0.43	0.46	0.46	0.46	0.46	0.46	0.46
Sat Flow, veh/h	1153	5085	1525	452	3592	34	759	1863	1554	894	1863	1553
Grp Volume(v), veh/h	156	832	395	172	105	111	140	401	97	42	641	35
Grp Sat Flow(s),veh/h/ln	1153	1695	1525	452	1770	1856	759	1863	1554	894	1863	1553
Q Serve(g_s), s	6.2	7.2	12.9	20.8	2.3	2.3	11.6	9.6	2.3	2.2	18.4	0.8
Cycle Q Clear(g_c), s	8.5	7.2	12.9	28.0	2.3	2.3	30.0	9.6	2.3	11.8	18.4	0.8
Prop In Lane	1.00		1.00	1.00		0.02	1.00		1.00	1.00		1.00
Lane Grp Cap(c), veh/h	566	2191	657	255	762	799	247	860	717	391	860	717
V/C Ratio(X)	0.28	0.38	0.60	0.67	0.14	0.14	0.57	0.47	0.14	0.11	0.75	0.05
Avail Cap(c_a), veh/h	566	2191	657	255	762	799	247	860	717	391	860	717
HCM Platoon Ratio	1.00	1.00	1.00	1.00	1.00	1.00	1.00	1.00	1.00	1.00	1.00	1.00
Upstream Filter(I)	1.00	1.00	1.00	1.00	1.00	1.00	1.00	1.00	1.00	1.00	1.00	1.00
Uniform Delay (d), s/veh	13.8	12.6	14.2	23.8	11.2	11.2	26.9	12.0	10.1	16.1	14.4	9.6
Incr Delay (d2), s/veh	1.2	0.5	4.0	13.4	0.4	0.4	9.2	1.8	0.4	0.6	5.8	0.1
Initial Q Delay(d3),s/veh	0.0	0.0	0.0	0.0	0.0	0.0	0.0	0.0	0.0	0.0	0.0	0.0
%ile BackOfQ(50%),veh/ln	2.1	3.5	6.1	4.0	1.2	1.3	3.1	5.3	1.1	0.6	10.7	0.4
LnGrp Delay(d),s/veh	15.0	13.1	18.3	37.2	11.6	11.6	36.0	13.8	10.4	16.6	20.2	9.8
LnGrp LOS	B	B	B	D	B	B	D	B	B	B	C	A
Approach Vol, veh/h		1383			388			638			718	
Approach Delay, s/veh		14.8			22.9			18.2			19.5	
Approach LOS		B			C			B			B	
Timer	1	2	3	4	5	6	7	8				
Assigned Phs		2		4		6		8				
Phs Duration (G+Y+Rc), s		33.5		31.5		33.5		31.5				
Change Period (Y+Rc), s		3.5		3.5		3.5		3.5				
Max Green Setting (Gmax), s		30.0		28.0		30.0		28.0				
Max Q Clear Time (g_c+I1), s		32.0		14.9		20.4		30.0				
Green Ext Time (p_c), s		0.0		6.5		3.3		0.0				
Intersection Summary												
HCM 2010 Ctrl Delay				17.6								
HCM 2010 LOS				B								

15: E 8th St/14th Ave & E 12th St
 HCM 2010 Signalized Intersection Summary

03/14/2019

												
Movement	EBL	EBT	EBR	WBL	WBT	WBR	NBL	NBT	NBR	SBL	SBT	SBR
Lane Configurations												
Traffic Volume (veh/h)	154	188	4	0	0	0	0	500	0	234	167	0
Future Volume (veh/h)	154	188	4	0	0	0	0	500	0	234	167	0
Number	1	6	16				7	4	14	3	8	18
Initial Q (Qb), veh	0	0	0				0	0	0	0	0	0
Ped-Bike Adj(A_pbT)	1.00		1.00				1.00		1.00	1.00		1.00
Parking Bus, Adj	1.00	1.00	1.00				1.00	1.00	1.00	1.00	1.00	1.00
Adj Sat Flow, veh/h/ln	1881	1881	1900				0	1881	0	1881	1881	0
Adj Flow Rate, veh/h	154	188	0				0	500	0	234	167	0
Adj No. of Lanes	1	2	0				0	2	0	1	3	0
Peak Hour Factor	1.00	1.00	1.00				1.00	1.00	1.00	1.00	1.00	1.00
Percent Heavy Veh, %	1	1	1				0	1	0	1	1	0
Cap, veh/h	441	880	0				0	1645	0	615	3081	0
Arrive On Green	0.25	0.25	0.00				0.00	0.46	0.00	0.09	0.60	0.00
Sat Flow, veh/h	1792	3668	0				0	3762	0	1792	5305	0
Grp Volume(v), veh/h	154	188	0				0	500	0	234	167	0
Grp Sat Flow(s),veh/h/ln	1792	1787	0				0	1787	0	1792	1712	0
Q Serve(g_s), s	4.6	2.7	0.0				0.0	5.7	0.0	4.1	0.9	0.0
Cycle Q Clear(g_c), s	4.6	2.7	0.0				0.0	5.7	0.0	4.1	0.9	0.0
Prop In Lane	1.00		0.00				0.00		0.00	1.00		0.00
Lane Grp Cap(c), veh/h	441	880	0				0	1645	0	615	3081	0
V/C Ratio(X)	0.35	0.21	0.00				0.00	0.30	0.00	0.38	0.05	0.00
Avail Cap(c_a), veh/h	441	880	0				0	1645	0	805	3081	0
HCM Platoon Ratio	1.00	1.00	1.00				1.00	1.00	1.00	1.00	1.00	1.00
Upstream Filter(I)	1.00	1.00	0.00				0.00	1.00	0.00	1.00	1.00	0.00
Uniform Delay (d), s/veh	20.2	19.5	0.0				0.0	11.0	0.0	7.1	5.4	0.0
Incr Delay (d2), s/veh	2.2	0.6	0.0				0.0	0.5	0.0	0.1	0.0	0.0
Initial Q Delay(d3),s/veh	0.0	0.0	0.0				0.0	0.0	0.0	0.0	0.0	0.0
%ile BackOfQ(50%),veh/ln	2.5	1.4	0.0				0.0	2.9	0.0	1.9	0.4	0.0
LnGrp Delay(d),s/veh	22.4	20.0	0.0				0.0	11.5	0.0	7.2	5.4	0.0
LnGrp LOS	C	C						B		A	A	
Approach Vol, veh/h		342						500			401	
Approach Delay, s/veh		21.1						11.5			6.4	
Approach LOS		C						B			A	
Timer	1	2	3	4	5	6	7	8				
Assigned Phs			3	4		6		8				
Phs Duration (G+Y+Rc), s			9.1	34.9		21.0		44.0				
Change Period (Y+Rc), s			3.0	5.0		5.0		5.0				
Max Green Setting (Gmax), s			13.0	23.0		16.0		39.0				
Max Q Clear Time (g_c+I1), s			6.1	7.7		6.6		2.9				
Green Ext Time (p_c), s			0.0	0.6		0.2		0.2				
Intersection Summary												
HCM 2010 Ctrl Delay			12.5									
HCM 2010 LOS			B									

16: Foothill & 14th Ave
 HCM Signalized Intersection Capacity Analysis

03/14/2019



Movement	EBL	EBT	EBR	WBL	WBT	WBR	NBL	NBT	NBR	SBL	SBT	SBR
Lane Configurations					↑↑						↑↑	
Traffic Volume (vph)	0	0	0	36	141	0	0	0	0	139	672	85
Future Volume (vph)	0	0	0	36	141	0	0	0	0	139	672	85
Ideal Flow (vphpl)	1900	1900	1900	1900	1900	1900	1900	1900	1900	1900	1900	1900
Total Lost time (s)					4.5						4.0	
Lane Util. Factor					0.95						0.95	
Frbp, ped/bikes					1.00						1.00	
Flpb, ped/bikes					1.00						1.00	
Frt					1.00						0.99	
Flt Protected					0.99						0.99	
Satd. Flow (prot)					3504						3453	
Flt Permitted					0.99						0.99	
Satd. Flow (perm)					3504						3453	
Peak-hour factor, PHF	1.00	1.00	1.00	1.00	1.00	1.00	1.00	1.00	1.00	1.00	1.00	1.00
Adj. Flow (vph)	0	0	0	36	141	0	0	0	0	139	672	85
RTOR Reduction (vph)	0	0	0	0	0	0	0	0	0	0	10	0
Lane Group Flow (vph)	0	0	0	0	177	0	0	0	0	0	886	0
Confl. Peds. (#/hr)	13		13			13	16		1			16
Confl. Bikes (#/hr)						10						2
Turn Type				Split	NA					Split	NA	
Protected Phases				5	5					6	6	
Permitted Phases												
Actuated Green, G (s)					4.3						31.0	
Effective Green, g (s)					4.3						31.0	
Actuated g/C Ratio					0.08						0.56	
Clearance Time (s)					4.5						4.0	
Vehicle Extension (s)					3.0						0.2	
Lane Grp Cap (vph)					273						1946	
v/s Ratio Prot					c0.05						c0.26	
v/s Ratio Perm												
v/c Ratio					0.65						0.46	
Uniform Delay, d1					24.6						7.0	
Progression Factor					1.77						1.00	
Incremental Delay, d2					5.2						0.8	
Delay (s)					48.6						7.8	
Level of Service					D						A	
Approach Delay (s)		0.0			48.6			0.0			7.8	
Approach LOS		A			D			A			A	
Intersection Summary												
HCM 2000 Control Delay			14.5		HCM 2000 Level of Service					B		
HCM 2000 Volume to Capacity ratio			0.41									
Actuated Cycle Length (s)			55.0		Sum of lost time (s)					14.0		
Intersection Capacity Utilization			44.5%		ICU Level of Service					A		
Analysis Period (min)			15									
c Critical Lane Group												

17: 14th Ave & Foothill Blvd
 HCM Signalized Intersection Capacity Analysis

03/14/2019



Movement	EBL	EBT	EBR	WBL	WBT	WBR	NBL	NBT	NBR	SBL	SBT	SBR
Lane Configurations		↕↕			↕↕			↕↕				
Traffic Volume (vph)	10	129	0	0	178	2	0	897	168	0	0	0
Future Volume (vph)	10	129	0	0	178	2	0	897	168	0	0	0
Ideal Flow (vphpl)	1900	1900	1900	1900	1900	1900	1900	1900	1900	1900	1900	1900
Total Lost time (s)		5.5			5.5			4.0				
Lane Util. Factor		0.95			0.95			0.95				
Frbp, ped/bikes		1.00			1.00			1.00				
Flpb, ped/bikes		1.00			1.00			1.00				
Frt		1.00			1.00			0.98				
Flt Protected		1.00			1.00			1.00				
Satd. Flow (prot)		3527			3532			3446				
Flt Permitted		0.94			1.00			1.00				
Satd. Flow (perm)		3310			3532			3446				
Peak-hour factor, PHF	1.00	1.00	1.00	1.00	1.00	1.00	1.00	1.00	1.00	1.00	1.00	1.00
Adj. Flow (vph)	10	129	0	0	178	2	0	897	168	0	0	0
RTOR Reduction (vph)	0	0	0	0	2	0	0	21	0	0	0	0
Lane Group Flow (vph)	0	139	0	0	178	0	0	1044	0	0	0	0
Confl. Peds. (#/hr)			5	5		10			3	3		
Confl. Bikes (#/hr)			1			10			8			
Turn Type	custom	NA			NA			NA				
Protected Phases	1	4 1			8			2				
Permitted Phases	4											
Actuated Green, G (s)		10.3			5.7			30.7				
Effective Green, g (s)		10.3			5.7			30.7				
Actuated g/C Ratio		0.19			0.10			0.56				
Clearance Time (s)					5.5			4.0				
Vehicle Extension (s)					0.2			0.2				
Lane Grp Cap (vph)		638			366			1923				
v/s Ratio Prot		c0.02			c0.05			c0.30				
v/s Ratio Perm		0.02										
v/c Ratio		0.22			0.49			0.54				
Uniform Delay, d1		18.9			23.3			7.7				
Progression Factor		1.79			1.00			1.00				
Incremental Delay, d2		0.1			0.4			1.1				
Delay (s)		34.0			23.6			8.8				
Level of Service		C			C			A				
Approach Delay (s)		34.0			23.6			8.8			0.0	
Approach LOS		C			C			A			A	
Intersection Summary												
HCM 2000 Control Delay			13.3									B
HCM 2000 Volume to Capacity ratio			0.50									
Actuated Cycle Length (s)			55.0								14.0	
Intersection Capacity Utilization			49.3%									A
Analysis Period (min)			15									

c Critical Lane Group

18: 23rd Ave & 16th St
 HCM Signalized Intersection Capacity Analysis

03/14/2019



Movement	WBL	WBR	NBT	NBR	SBL	SBT
Lane Configurations	W	R	T	R	L	T
Traffic Volume (vph)	22	42	336	22	24	318
Future Volume (vph)	22	42	336	22	24	318
Ideal Flow (vphpl)	1900	1900	1900	1900	1900	1900
Total Lost time (s)	4.5		4.0			4.0
Lane Util. Factor	1.00		1.00			1.00
Frbp, ped/bikes	0.97		0.99			1.00
Flpb, ped/bikes	1.00		1.00			1.00
Frt	0.91		0.99			1.00
Flt Protected	0.98		1.00			1.00
Satd. Flow (prot)	1622		1835			1850
Flt Permitted	0.98		1.00			0.96
Satd. Flow (perm)	1622		1835			1789
Peak-hour factor, PHF	1.00	1.00	1.00	1.00	1.00	1.00
Adj. Flow (vph)	22	42	336	22	24	318
RTOR Reduction (vph)	37	0	4	0	0	0
Lane Group Flow (vph)	27	0	354	0	0	342
Confl. Peds. (#/hr)		3		62	62	
Confl. Bikes (#/hr)		3		7		
Turn Type	Prot		NA		Perm	NA
Protected Phases	7		2			2
Permitted Phases					2	
Actuated Green, G (s)	5.7		19.8			19.8
Effective Green, g (s)	5.7		19.8			19.8
Actuated g/C Ratio	0.11		0.38			0.38
Clearance Time (s)	4.5		4.0			4.0
Vehicle Extension (s)	3.0		3.0			3.0
Lane Grp Cap (vph)	179		704			686
v/s Ratio Prot	c0.02		c0.19			
v/s Ratio Perm						0.19
v/c Ratio	0.15		0.50			0.50
Uniform Delay, d1	20.8		12.1			12.1
Progression Factor	1.00		1.00			0.25
Incremental Delay, d2	0.4		0.6			0.5
Delay (s)	21.1		12.7			3.5
Level of Service	C		B			A
Approach Delay (s)	21.1		12.7			3.5
Approach LOS	C		B			A












Intersection Summary

HCM 2000 Control Delay	9.3	HCM 2000 Level of Service	A
HCM 2000 Volume to Capacity ratio	0.28		
Actuated Cycle Length (s)	51.6	Sum of lost time (s)	12.5
Intersection Capacity Utilization	47.8%	ICU Level of Service	A
Analysis Period (min)	15		

c Critical Lane Group

19: 7th Ave & Embarcadero W
 HCM 2010 Signalized Intersection Summary

03/14/2019

								
Movement	EBT	EBR	WBL	WBT	NBL	NBR		
Lane Configurations								
Traffic Volume (veh/h)	2086	185	102	558	280	33		
Future Volume (veh/h)	2086	185	102	558	280	33		
Number	4	14	3	8	5	12		
Initial Q (Qb), veh	0	0	0	0	0	0		
Ped-Bike Adj(A_pbT)		0.83	0.99		1.00	1.00		
Parking Bus, Adj	1.00	1.00	1.00	1.00	1.00	1.00		
Adj Sat Flow, veh/h/ln	1863	1900	1863	1863	1863	1863		
Adj Flow Rate, veh/h	2086	185	102	558	280	28		
Adj No. of Lanes	2	0	1	2	1	1		
Peak Hour Factor	1.00	1.00	1.00	1.00	1.00	1.00		
Percent Heavy Veh, %	2	2	2	2	2	2		
Cap, veh/h	2443	209	189	2670	290	259		
Arrive On Green	1.00	1.00	1.00	1.00	0.16	0.16		
Sat Flow, veh/h	3331	277	163	3632	1774	1583		
Grp Volume(v), veh/h	1106	1165	102	558	280	28		
Grp Sat Flow(s),veh/h/ln	1770	1746	163	1770	1774	1583		
Q Serve(g_s), s	0.0	0.0	0.0	0.0	17.2	1.7		
Cycle Q Clear(g_c), s	0.0	0.0	0.0	0.0	17.2	1.7		
Prop In Lane		0.16	1.00		1.00	1.00		
Lane Grp Cap(c), veh/h	1335	1317	189	2670	290	259		
V/C Ratio(X)	0.83	0.88	0.54	0.21	0.96	0.11		
Avail Cap(c_a), veh/h	1335	1317	189	2670	290	259		
HCM Platoon Ratio	2.00	2.00	2.00	2.00	1.00	1.00		
Upstream Filter(I)	0.09	0.09	0.88	0.88	1.00	1.00		
Uniform Delay (d), s/veh	0.0	0.0	0.0	0.0	45.7	39.2		
Incr Delay (d2), s/veh	0.6	0.9	9.4	0.2	44.5	0.8		
Initial Q Delay(d3),s/veh	0.0	0.0	0.0	0.0	0.0	0.0		
%ile BackOfQ(50%),veh/ln	0.2	0.3	0.5	0.1	12.1	0.8		
LnGrp Delay(d),s/veh	0.6	0.9	9.4	0.2	90.2	40.0		
LnGrp LOS	A	A	A	A	F	D		
Approach Vol, veh/h	2271			660	308			
Approach Delay, s/veh	0.8			1.6	85.6			
Approach LOS	A			A	F			
Timer	1	2	3	4	5	6	7	8
Assigned Phs		2		4				8
Phs Duration (G+Y+Rc), s		22.5		87.5				87.5
Change Period (Y+Rc), s		4.5		4.5				4.5
Max Green Setting (Gmax), s		18.0		83.0				83.0
Max Q Clear Time (g_c+I1), s		19.2		2.0				2.0
Green Ext Time (p_c), s		0.0		51.0				13.5
Intersection Summary								
HCM 2010 Ctrl Delay			9.0					
HCM 2010 LOS			A					

20: 8th Ave & Embarcadero W
 HCM 2010 Signalized Intersection Summary

03/14/2019

	→	↘	↙	←	↖	↗		
Movement	EBT	EBR	WBL	WBT	NBL	NBR		
Lane Configurations	↑↑		↙	↑	↖	↗		
Traffic Volume (veh/h)	1934	185	103	434	226	33		
Future Volume (veh/h)	1934	185	103	434	226	33		
Number	4	14	3	8	5	12		
Initial Q (Qb), veh	0	0	0	0	0	0		
Ped-Bike Adj(A_pbT)		1.00	1.00		1.00	1.00		
Parking Bus, Adj	1.00	1.00	1.00	1.00	1.00	1.00		
Adj Sat Flow, veh/h/ln	1863	1900	1863	1863	1863	1863		
Adj Flow Rate, veh/h	1934	185	103	434	226	5		
Adj No. of Lanes	2	0	1	1	1	1		
Peak Hour Factor	1.00	1.00	1.00	1.00	1.00	1.00		
Percent Heavy Veh, %	2	2	2	2	2	2		
Cap, veh/h	2467	232	209	1406	290	259		
Arrive On Green	1.00	1.00	1.00	1.00	0.16	0.16		
Sat Flow, veh/h	3363	308	191	1863	1774	1583		
Grp Volume(v), veh/h	1032	1087	103	434	226	5		
Grp Sat Flow(s),veh/h/ln	1770	1808	191	1863	1774	1583		
Q Serve(g_s), s	0.0	0.0	0.0	0.0	13.4	0.3		
Cycle Q Clear(g_c), s	0.0	0.0	0.0	0.0	13.4	0.3		
Prop In Lane		0.17	1.00		1.00	1.00		
Lane Grp Cap(c), veh/h	1335	1365	209	1406	290	259		
V/C Ratio(X)	0.77	0.80	0.49	0.31	0.78	0.02		
Avail Cap(c_a), veh/h	1335	1365	209	1406	290	259		
HCM Platoon Ratio	2.00	2.00	2.00	2.00	1.00	1.00		
Upstream Filter(I)	0.32	0.32	1.00	1.00	1.00	1.00		
Uniform Delay (d), s/veh	0.0	0.0	0.0	0.0	44.1	38.6		
Incr Delay (d2), s/veh	1.5	1.6	8.0	0.6	18.4	0.1		
Initial Q Delay(d3),s/veh	0.0	0.0	0.0	0.0	0.0	0.0		
%ile BackOfQ(50%),veh/ln	0.5	0.6	0.5	0.2	8.1	0.1		
LnGrp Delay(d),s/veh	1.5	1.6	8.0	0.6	62.5	38.7		
LnGrp LOS	A	A	A	A	E	D		
Approach Vol, veh/h	2119			537	231			
Approach Delay, s/veh	1.6			2.0	62.0			
Approach LOS	A			A	E			
Timer	1	2	3	4	5	6	7	8
Assigned Phs		2		4				8
Phs Duration (G+Y+Rc), s		22.5		87.5				87.5
Change Period (Y+Rc), s		4.5		4.5				4.5
Max Green Setting (Gmax), s		18.0		83.0				83.0
Max Q Clear Time (g_c+I1), s		15.4		2.0				2.0
Green Ext Time (p_c), s		0.2		42.6				10.2
Intersection Summary								
HCM 2010 Ctrl Delay			6.5					
HCM 2010 LOS			A					

Intersection						
Int Delay, s/veh	0.3					
Movement	EBT	EBR	WBL	WBT	NBL	NBR
Lane Configurations	↑↑			↑		↑
Traffic Vol, veh/h	1783	184	0	537	0	32
Future Vol, veh/h	1783	184	0	537	0	32
Conflicting Peds, #/hr	0	20	0	0	0	0
Sign Control	Free	Free	Free	Free	Stop	Stop
RT Channelized	-	None	-	None	-	None
Storage Length	-	-	-	-	-	0
Veh in Median Storage, #	0	-	-	0	0	-
Grade, %	0	-	-	0	0	-
Peak Hour Factor	100	100	100	100	100	100
Heavy Vehicles, %	2	2	2	2	2	2
Mvmt Flow	1783	184	0	537	0	32












Major/Minor	Major1	Major2	Minor1		
Conflicting Flow All	0	0	-	-	1004
Stage 1	-	-	-	-	-
Stage 2	-	-	-	-	-
Critical Hdwy	-	-	-	-	6.93
Critical Hdwy Stg 1	-	-	-	-	-
Critical Hdwy Stg 2	-	-	-	-	-
Follow-up Hdwy	-	-	-	-	3.319
Pot Cap-1 Maneuver	-	-	0	-	241
Stage 1	-	-	0	-	-
Stage 2	-	-	0	-	-
Platoon blocked, %	-	-	-	-	-
Mov Cap-1 Maneuver	-	-	-	-	236
Mov Cap-2 Maneuver	-	-	-	-	-
Stage 1	-	-	-	-	-
Stage 2	-	-	-	-	-

Approach	EB	WB	NB
HCM Control Delay, s	0	0	22.6
HCM LOS			C

Minor Lane/Major Mvmt	NBLn1	EBT	EBR	WBT
Capacity (veh/h)	236	-	-	-
HCM Lane V/C Ratio	0.136	-	-	-
HCM Control Delay (s)	22.6	-	-	-
HCM Lane LOS	C	-	-	-
HCM 95th %tile Q(veh)	0.5	-	-	-

22: 4th Ave & Embarcadero W
 HCM 2010 Signalized Intersection Summary












03/14/2019

								
Movement	EBT	EBR	WBL	WBT	NBL	NBR		
Lane Configurations								
Traffic Volume (veh/h)	1063	49	100	797	29	19		
Future Volume (veh/h)	1063	49	100	797	29	19		
Number	4	14	3	8	5	12		
Initial Q (Qb), veh	0	0	0	0	0	0		
Ped-Bike Adj(A_pbT)		0.83	1.00		1.00	1.00		
Parking Bus, Adj	1.00	1.00	1.00	1.00	1.00	1.00		
Adj Sat Flow, veh/h/ln	1863	1900	1863	1863	1863	1863		
Adj Flow Rate, veh/h	1063	49	100	797	29	3		
Adj No. of Lanes	1	0	1	2	1	1		
Peak Hour Factor	1.00	1.00	1.00	1.00	1.00	1.00		
Percent Heavy Veh, %	2	2	2	2	2	2		
Cap, veh/h	1319	61	254	2670	290	259		
Arrive On Green	0.75	0.75	1.00	1.00	0.16	0.16		
Sat Flow, veh/h	1748	81	505	3632	1774	1583		
Grp Volume(v), veh/h	0	1112	100	797	29	3		
Grp Sat Flow(s),veh/h/ln	0	1829	505	1770	1774	1583		
Q Serve(g_s), s	0.0	41.9	14.9	0.0	1.5	0.2		
Cycle Q Clear(g_c), s	0.0	41.9	56.8	0.0	1.5	0.2		
Prop In Lane		0.04	1.00		1.00	1.00		
Lane Grp Cap(c), veh/h	0	1380	254	2670	290	259		
V/C Ratio(X)	0.00	0.81	0.39	0.30	0.10	0.01		
Avail Cap(c_a), veh/h	0	1380	254	2670	290	259		
HCM Platoon Ratio	1.00	1.00	2.00	2.00	1.00	1.00		
Upstream Filter(I)	0.00	1.00	0.09	0.09	1.00	1.00		
Uniform Delay (d), s/veh	0.0	8.5	14.3	0.0	39.1	38.5		
Incr Delay (d2), s/veh	0.0	5.1	0.4	0.0	0.7	0.1		
Initial Q Delay(d3),s/veh	0.0	0.0	0.0	0.0	0.0	0.0		
%ile BackOfQ(50%),veh/ln	0.0	22.7	2.1	0.0	0.8	0.1		
LnGrp Delay(d),s/veh	0.0	13.6	14.8	0.0	39.8	38.6		
LnGrp LOS		B	B	A	D	D		
Approach Vol, veh/h	1112			897	32			
Approach Delay, s/veh	13.6			1.7	39.7			
Approach LOS	B			A	D			
Timer	1	2	3	4	5	6	7	8
Assigned Phs		2		4				8
Phs Duration (G+Y+Rc), s		22.5		87.5				87.5
Change Period (Y+Rc), s		4.5		4.5				4.5
Max Green Setting (Gmax), s		18.0		83.0				83.0
Max Q Clear Time (g_c+I1), s		3.5		43.9				58.8
Green Ext Time (p_c), s		0.0		13.8				7.5
Intersection Summary								
HCM 2010 Ctrl Delay			8.7					
HCM 2010 LOS			A					

HCM 2010 Signalized Intersection Summary

1: Embarcadero W & Oak St

05/05/2020

								
Movement	EBL	EBR	NBL	NBT	SBT	SBR		
Lane Configurations								
Traffic Volume (veh/h)	79	84	259	697	217	21		
Future Volume (veh/h)	79	84	259	697	217	21		
Number	7	14	5	2	6	16		
Initial Q (Qb), veh	0	0	0	0	0	0		
Ped-Bike Adj(A_pbT)	1.00	1.00	0.98			0.95		
Parking Bus, Adj	1.00	1.00	1.00	1.00	1.00	1.00		
Adj Sat Flow, veh/h/ln	1583	1583	1583	1583	1583	1710		
Adj Flow Rate, veh/h	79	84	259	697	217	21		
Adj No. of Lanes	1	1	1	1	1	0		
Peak Hour Factor	1.00	1.00	1.00	1.00	1.00	1.00		
Percent Heavy Veh, %	8	8	8	8	8	8		
Cap, veh/h	147	131	780	1123	1003	97		
Arrive On Green	0.10	0.10	0.71	0.71	0.71	0.71		
Sat Flow, veh/h	1508	1346	952	1583	1415	137		
Grp Volume(v), veh/h	79	84	259	697	0	238		
Grp Sat Flow(s),veh/h/ln	1508	1346	952	1583	0	1552		
Q Serve(g_s), s	2.3	2.8	6.0	10.6	0.0	2.5		
Cycle Q Clear(g_c), s	2.3	2.8	8.4	10.6	0.0	2.5		
Prop In Lane	1.00	1.00	1.00			0.09		
Lane Grp Cap(c), veh/h	147	131	780	1123	0	1100		
V/C Ratio(X)	0.54	0.64	0.33	0.62	0.00	0.22		
Avail Cap(c_a), veh/h	583	521	780	1123	0	1100		
HCM Platoon Ratio	1.00	1.00	1.00	1.00	1.00	1.00		
Upstream Filter(I)	1.00	1.00	1.00	1.00	0.00	1.00		
Uniform Delay (d), s/veh	20.0	20.2	3.8	3.5	0.0	2.3		
Incr Delay (d2), s/veh	3.0	5.1	1.1	2.6	0.0	0.5		
Initial Q Delay(d3),s/veh	0.0	0.0	0.0	0.0	0.0	0.0		
%ile BackOfQ(50%),veh/ln	1.1	1.2	1.8	5.3	0.0	1.1		
LnGrp Delay(d),s/veh	23.1	25.4	4.9	6.1	0.0	2.8		
LnGrp LOS	C	C	A	A		A		
Approach Vol, veh/h	163			956	238			
Approach Delay, s/veh	24.2			5.8	2.8			
Approach LOS	C			A	A			
Timer	1	2	3	4	5	6	7	8
Assigned Phs		2		4		6		
Phs Duration (G+Y+Rc), s		37.5		9.0		37.5		
Change Period (Y+Rc), s		4.5		4.5		4.5		
Max Green Setting (Gmax), s		33.0		18.0		33.0		
Max Q Clear Time (g_c+I1), s		12.6		4.8		4.5		
Green Ext Time (p_c), s		6.5		0.4		1.4		
Intersection Summary								
HCM 2010 Ctrl Delay			7.5					
HCM 2010 LOS			A					

2: Broadway & 5th Street HCM Signalized Intersection Capacity Analysis

03/14/2019



Movement	EBL	EBT	EBR	EBR2	NBT	NBR	NBR2	SBL2	SBL	SBT
Lane Configurations		↕↕	↗	↗	↕↕	↘			↘	↕↕
Traffic Volume (vph)	16	146	713	52	238	55	170	204	114	218
Future Volume (vph)	16	146	713	52	238	55	170	204	114	218
Ideal Flow (vphp)	1900	1900	1900	1900	1900	1900	1900	1900	1900	1900
Total Lost time (s)		5.5	5.5	5.5	4.5	4.5			4.5	4.5
Lane Util. Factor		0.91	0.91	1.00	0.95	1.00			0.91	0.91
Frbp, ped/bikes		1.00	1.00	0.98	1.00	0.88			1.00	1.00
Flpb, ped/bikes		1.00	1.00	1.00	1.00	1.00			1.00	0.99
Frt		0.90	0.85	0.85	1.00	0.85			1.00	1.00
Flt Protected		1.00	1.00	1.00	1.00	1.00			0.95	0.98
Satd. Flow (prot)		2580	1225	1321	3008	1186			1369	2805
Flt Permitted		1.00	1.00	1.00	1.00	1.00			0.95	0.84
Satd. Flow (perm)		2580	1225	1321	3008	1186			1369	2379
Peak-hour factor, PHF	1.00	1.00	1.00	1.00	1.00	1.00	1.00	1.00	1.00	1.00
Adj. Flow (vph)	16	146	713	52	238	55	170	204	114	218
RTOR Reduction (vph)	0	0	0	36	0	144	0	0	0	0
Lane Group Flow (vph)	0	519	356	16	238	81	0	0	215	321
Confl. Peds. (#/hr)				5		55			55	
Confl. Bikes (#/hr)						1				
Heavy Vehicles (%)	8%	8%	8%	8%	8%	8%	8%	8%	8%	8%
Turn Type	Perm	NA	Prot	Perm	NA	Perm		Prot	Prot	NA
Protected Phases		4	4		2			1	1	6
Permitted Phases	4			4		2				
Actuated Green, G (s)		22.5	22.5	22.5	11.5	11.5			26.5	42.5
Effective Green, g (s)		22.5	22.5	22.5	11.5	11.5			26.5	42.5
Actuated g/C Ratio		0.30	0.30	0.30	0.15	0.15			0.35	0.57
Clearance Time (s)		5.5	5.5	5.5	4.5	4.5			4.5	4.5
Vehicle Extension (s)		2.0	2.0	2.0	2.0	2.0			2.0	2.0
Lane Grp Cap (vph)		774	367	396	461	181			483	1498
v/s Ratio Prot			c0.29		c0.08				c0.16	0.08
v/s Ratio Perm		0.20		0.01		0.07				0.05
v/c Ratio		0.93dr	0.97	0.04	0.52	0.45			0.45	0.21
Uniform Delay, d1		23.0	25.9	18.6	29.2	28.9			18.6	8.0
Progression Factor		1.00	1.00	1.00	1.00	1.00			1.00	1.00
Incremental Delay, d2		1.8	38.8	0.0	0.4	0.6			3.0	0.3
Delay (s)		24.8	64.7	18.6	29.6	29.5			21.6	8.3
Level of Service		C	E	B	C	C			C	A
Approach Delay (s)		39.8			29.6					13.6
Approach LOS		D			C					B

Intersection Summary

HCM 2000 Control Delay	30.0	HCM 2000 Level of Service	C
HCM 2000 Volume to Capacity ratio	0.65		
Actuated Cycle Length (s)	75.0	Sum of lost time (s)	14.5
Intersection Capacity Utilization	82.0%	ICU Level of Service	E
Analysis Period (min)	15		

dr Defacto Right Lane. Recode with 1 though lane as a right lane.

c Critical Lane Group

3: 6th Street & Jackson St
 HCM Signalized Intersection Capacity Analysis
























03/14/2019



Movement	WBL	WBT	WBR2	NBL2	NBT	SBT	SBR	SER2
Lane Configurations	↶	↑	↷	↶	↑	↷		↷
Traffic Volume (vph)	15	527	112	184	415	139	412	1066
Future Volume (vph)	15	527	112	184	415	139	412	1066
Ideal Flow (vphpl)	1900	1900	1900	1900	1900	1900	1900	1900
Total Lost time (s)	5.5	5.5	5.5	5.5	5.5	5.5		5.5
Lane Util. Factor	1.00	1.00	1.00	1.00	1.00	1.00		1.00
Frpb, ped/bikes	1.00	1.00	0.98	1.00	1.00	0.98		1.00
Flpb, ped/bikes	0.99	1.00	1.00	1.00	1.00	1.00		1.00
Frt	1.00	1.00	0.85	1.00	1.00	0.90		0.86
Flt Protected	0.95	1.00	1.00	0.95	1.00	1.00		1.00
Satd. Flow (prot)	1566	1660	1383	1573	1660	1458		1450
Flt Permitted	0.95	1.00	1.00	0.32	1.00	1.00		1.00
Satd. Flow (perm)	1566	1660	1383	526	1660	1458		1450
Peak-hour factor, PHF	1.00	1.00	1.00	1.00	1.00	1.00	1.00	0.92
Adj. Flow (vph)	15	527	112	184	415	139	412	1159
RTOR Reduction (vph)	0	0	72	0	0	0	0	0
Lane Group Flow (vph)	15	527	40	184	415	551	0	1159
Confl. Peds. (#/hr)	3		5	6				6
Confl. Bikes (#/hr)			1					7
Heavy Vehicles (%)	3%	3%	3%	3%	3%	3%	3%	2%
Turn Type	Perm	NA	Perm	Perm	NA	NA		Perm
Protected Phases		8			2	6		
Permitted Phases	8		8	2				6 8
Actuated Green, G (s)	25.5	25.5	25.5	34.5	34.5	34.5		71.0
Effective Green, g (s)	25.5	25.5	25.5	34.5	34.5	34.5		71.0
Actuated g/C Ratio	0.36	0.36	0.36	0.49	0.49	0.49		1.00
Clearance Time (s)	5.5	5.5	5.5	5.5	5.5	5.5		
Vehicle Extension (s)	3.0	3.0	3.0	3.0	3.0	3.0		
Lane Grp Cap (vph)	562	596	496	255	806	708		1450
v/s Ratio Prot		0.32			0.25	0.38		
v/s Ratio Perm	0.01		0.03	0.35				c0.80
v/c Ratio	0.03	0.88	0.08	0.72	0.51	0.78		0.80
Uniform Delay, d1	14.7	21.4	15.0	14.4	12.5	15.1		0.0
Progression Factor	1.00	1.00	1.00	1.00	1.00	1.00		1.00
Incremental Delay, d2	0.0	14.6	0.1	16.2	2.3	8.2		3.2
Delay (s)	14.7	35.9	15.1	30.6	14.9	23.3		3.2
Level of Service	B	D	B	C	B	C		A
Approach Delay (s)		31.9			19.7	23.3		
Approach LOS		C			B	C		
Intersection Summary								
HCM 2000 Control Delay			16.6		HCM 2000 Level of Service			B
HCM 2000 Volume to Capacity ratio			0.95					
Actuated Cycle Length (s)			71.0		Sum of lost time (s)			11.0
Intersection Capacity Utilization			170.6%		ICU Level of Service			H
Analysis Period (min)			15					
c Critical Lane Group								





















4: 5th Ave & Embarcadero W
 HCM 2010 Signalized Intersection Summary

03/14/2019

												
Movement	EBL	EBT	EBR	WBL	WBT	WBR	NBL	NBT	NBR	SBL	SBT	SBR
Lane Configurations		 			 					 		
Traffic Volume (veh/h)	68	322	19	35	732	474	88	82	83	465	21	22
Future Volume (veh/h)	68	322	19	35	732	474	88	82	83	465	21	22
Number	7	4	14	3	8	18	5	2	12	1	6	16
Initial Q (Qb), veh	0	0	0	0	0	0	0	0	0	0	0	0
Ped-Bike Adj(A_pbT)	1.00		1.00	1.00		0.98	1.00		0.99	1.00		0.99
Parking Bus, Adj	1.00	1.00	1.00	1.00	1.00	1.00	1.00	1.00	1.00	1.00	1.00	1.00
Adj Sat Flow, veh/h/ln	1845	1845	1900	1845	1845	1900	1845	1845	1900	1845	1845	1900
Adj Flow Rate, veh/h	68	322	19	35	732	474	88	82	83	465	21	10
Adj No. of Lanes	1	2	0	1	2	0	1	1	0	2	1	0
Peak Hour Factor	1.00	1.00	1.00	1.00	1.00	1.00	1.00	1.00	1.00	1.00	1.00	1.00
Percent Heavy Veh, %	3	3	3	3	3	3	3	3	3	3	3	3
Cap, veh/h	335	1874	110	650	1130	727	225	107	108	562	195	93
Arrive On Green	1.00	1.00	1.00	1.00	1.00	1.00	0.13	0.13	0.13	0.17	0.17	0.17
Sat Flow, veh/h	457	3364	198	1022	2029	1305	1757	838	848	3408	1179	562
Grp Volume(v), veh/h	68	167	174	35	631	575	88	0	165	465	0	31
Grp Sat Flow(s),veh/h/ln	457	1752	1809	1022	1752	1582	1757	0	1686	1704	0	1741
Q Serve(g_s), s	0.0	0.0	0.0	0.0	0.0	0.0	4.1	0.0	8.5	11.9	0.0	1.4
Cycle Q Clear(g_c), s	0.0	0.0	0.0	0.0	0.0	0.0	4.1	0.0	8.5	11.9	0.0	1.4
Prop In Lane	1.00		0.11	1.00		0.82	1.00		0.50	1.00		0.32
Lane Grp Cap(c), veh/h	335	976	1008	650	976	881	225	0	216	562	0	287
V/C Ratio(X)	0.20	0.17	0.17	0.05	0.65	0.65	0.39	0.00	0.77	0.83	0.00	0.11
Avail Cap(c_a), veh/h	335	976	1008	650	976	881	351	0	337	685	0	350
HCM Platoon Ratio	2.00	2.00	2.00	2.00	2.00	2.00	1.00	1.00	1.00	1.00	1.00	1.00
Upstream Filter(I)	0.93	0.93	0.93	0.80	0.80	0.80	1.00	0.00	1.00	1.00	0.00	1.00
Uniform Delay (d), s/veh	0.0	0.0	0.0	0.0	0.0	0.0	36.0	0.0	37.9	36.3	0.0	31.9
Incr Delay (d2), s/veh	1.3	0.4	0.3	0.1	2.7	3.0	1.1	0.0	5.6	7.0	0.0	0.2
Initial Q Delay(d3),s/veh	0.0	0.0	0.0	0.0	0.0	0.0	0.0	0.0	0.0	0.0	0.0	0.0
%ile BackOfQ(50%),veh/ln	0.1	0.1	0.1	0.0	0.7	0.7	2.1	0.0	4.3	6.1	0.0	0.7
LnGrp Delay(d),s/veh	1.3	0.4	0.3	0.1	2.7	3.0	37.1	0.0	43.5	43.3	0.0	32.1
LnGrp LOS	A	A	A	A	A	A	D		D	D		C
Approach Vol, veh/h		409			1241			253				496
Approach Delay, s/veh		0.5			2.8			41.3				42.6
Approach LOS		A			A			D				D
Timer	1	2	3	4	5	6	7	8				
Assigned Phs		2		4		6		8				
Phs Duration (G+Y+Rc), s		16.0		54.6		19.4		54.6				
Change Period (Y+Rc), s		4.5		4.5		4.5		4.5				
Max Green Setting (Gmax), s		18.0		40.4		18.1		40.4				
Max Q Clear Time (g_c+I1), s		10.5		2.0		13.9		2.0				
Green Ext Time (p_c), s		0.7		3.3		0.8		11.6				
Intersection Summary												
HCM 2010 Ctrl Delay	14.7											
HCM 2010 LOS	B											























5: 6th Ave/880 Off-Ramp & Embarcadero W
 HCM 2010 Signalized Intersection Summary

03/14/2019

												
Movement	EBL	EBT	EBR	WBL	WBT	WBR	NBL	NBT	NBR	SBL	SBT	SBR
Lane Configurations												
Traffic Volume (veh/h)	0	788	65	13	654	0	270	0	128	98	25	302
Future Volume (veh/h)	0	788	65	13	654	0	270	0	128	98	25	302
Number	7	4	14	3	8	18	5	2	12	1	6	16
Initial Q (Qb), veh	0	0	0	0	0	0	0	0	0	0	0	0
Ped-Bike Adj(A_pbT)	1.00		0.84	0.96		1.00	1.00		1.00	1.00		1.00
Parking Bus, Adj	1.00	1.00	1.00	1.00	1.00	1.00	1.00	1.00	1.00	1.00	1.00	1.00
Adj Sat Flow, veh/h/ln	0	1830	1900	1863	1827	0	1863	0	1863	1827	1863	1827
Adj Flow Rate, veh/h	0	788	65	13	654	0	270	0	26	98	25	157
Adj No. of Lanes	0	2	0	1	2	0	1	0	1	1	1	1
Peak Hour Factor	1.00	1.00	1.00	1.00	1.00	1.00	1.00	1.00	1.00	1.00	1.00	1.00
Percent Heavy Veh, %	0	4	4	2	4	0	2	0	2	4	2	4
Cap, veh/h	0	2471	204	557	2681	0	0	0	0	222	238	198
Arrive On Green	0.00	1.00	1.00	1.00	1.00	0.00	0.00	0.00	0.00	0.13	0.13	0.13
Sat Flow, veh/h	0	3290	264	617	3563	0		0		1740	1863	1553
Grp Volume(v), veh/h	0	428	425	13	654	0		0.0		98	25	157
Grp Sat Flow(s),veh/h/ln	0	1738	1724	617	1736	0				1740	1863	1553
Q Serve(g_s), s	0.0	0.0	0.0	0.0	0.0	0.0				4.7	1.1	8.8
Cycle Q Clear(g_c), s	0.0	0.0	0.0	0.0	0.0	0.0				4.7	1.1	8.8
Prop In Lane	0.00		0.15	1.00		0.00				1.00		1.00
Lane Grp Cap(c), veh/h	0	1343	1332	557	2681	0				222	238	198
V/C Ratio(X)	0.00	0.32	0.32	0.02	0.24	0.00				0.44	0.11	0.79
Avail Cap(c_a), veh/h	0	1343	1332	557	2681	0				396	424	354
HCM Platoon Ratio	1.00	2.00	2.00	2.00	2.00	1.00				1.00	1.00	1.00
Upstream Filter(I)	0.00	0.86	0.86	0.98	0.98	0.00				1.00	1.00	1.00
Uniform Delay (d), s/veh	0.0	0.0	0.0	0.0	0.0	0.0				36.3	34.7	38.1
Incr Delay (d2), s/veh	0.0	0.5	0.5	0.1	0.2	0.0				1.4	0.2	7.0
Initial Q Delay(d3),s/veh	0.0	0.0	0.0	0.0	0.0	0.0				0.0	0.0	0.0
%ile BackOfQ(50%),veh/ln	0.0	0.2	0.2	0.0	0.1	0.0				2.3	0.6	4.2
LnGrp Delay(d),s/veh	0.0	0.5	0.5	0.1	0.2	0.0				37.7	34.9	45.1
LnGrp LOS		A	A	A	A					D	C	D
Approach Vol, veh/h		853			667						280	
Approach Delay, s/veh		0.5			0.2						41.6	
Approach LOS		A			A						D	
Timer	1	2	3	4	5	6	7	8				
Assigned Phs				4		6		8				
Phs Duration (G+Y+Rc), s				74.0		16.0		74.0				
Change Period (Y+Rc), s				4.5		4.5		4.5				
Max Green Setting (Gmax), s				33.5		20.5		33.5				
Max Q Clear Time (g_c+I1), s				2.0		10.8		2.0				
Green Ext Time (p_c), s				6.4		0.6		5.2				
Intersection Summary												
HCM 2010 Ctrl Delay			6.8									
HCM 2010 LOS			A									

















6: Webster St & Atlantic Ave
 HCM 2010 Signalized Intersection Summary

03/14/2019

												
Movement	EBL	EBT	EBR	WBL	WBT	WBR	NBL	NBT	NBR	SBL	SBT	SBR
Lane Configurations												
Traffic Volume (veh/h)	178	305	146	23	374	46	140	539	66	91	371	353
Future Volume (veh/h)	178	305	146	23	374	46	140	539	66	91	371	353
Number	7	4	14	3	8	18	5	2	12	1	6	16
Initial Q (Qb), veh	0	0	0	0	0	0	0	0	0	0	0	0
Ped-Bike Adj(A_pbT)	1.00		0.96	1.00		0.92	1.00		0.96	1.00		0.95
Parking Bus, Adj	1.00	1.00	1.00	1.00	1.00	1.00	1.00	1.00	1.00	1.00	1.00	1.00
Adj Sat Flow, veh/h/ln	1827	1827	1827	1827	1827	1900	1827	1827	1900	1827	1827	1827
Adj Flow Rate, veh/h	193	332	21	25	407	50	152	586	72	99	403	89
Adj No. of Lanes	2	2	1	1	2	0	2	2	0	1	2	1
Peak Hour Factor	0.92	0.92	0.92	0.92	0.92	0.92	0.92	0.92	0.92	0.92	0.92	0.92
Percent Heavy Veh, %	4	4	4	4	4	4	4	4	4	4	4	4
Cap, veh/h	640	658	282	415	735	89	233	873	107	127	994	423
Arrive On Green	0.19	0.19	0.19	0.24	0.24	0.24	0.07	0.28	0.28	0.07	0.29	0.29
Sat Flow, veh/h	3375	3471	1489	1740	3081	375	3375	3095	379	1740	3471	1478
Grp Volume(v), veh/h	193	332	21	25	228	229	152	328	330	99	403	89
Grp Sat Flow(s),veh/h/ln	1688	1736	1489	1740	1736	1720	1688	1736	1739	1740	1736	1478
Q Serve(g_s), s	3.9	6.7	0.9	0.9	9.0	9.2	3.4	13.1	13.2	4.4	7.4	3.6
Cycle Q Clear(g_c), s	3.9	6.7	0.9	0.9	9.0	9.2	3.4	13.1	13.2	4.4	7.4	3.6
Prop In Lane	1.00		1.00	1.00		0.22	1.00		0.22	1.00		1.00
Lane Grp Cap(c), veh/h	640	658	282	415	414	410	233	490	491	127	994	423
V/C Ratio(X)	0.30	0.50	0.07	0.06	0.55	0.56	0.65	0.67	0.67	0.78	0.41	0.21
Avail Cap(c_a), veh/h	1075	1105	474	554	553	548	430	730	731	288	1592	678
HCM Platoon Ratio	1.00	1.00	1.00	1.00	1.00	1.00	1.00	1.00	1.00	1.00	1.00	1.00
Upstream Filter(I)	1.00	1.00	1.00	1.00	1.00	1.00	1.00	1.00	1.00	1.00	1.00	1.00
Uniform Delay (d), s/veh	27.3	28.5	26.1	23.1	26.2	26.3	35.6	24.9	25.0	35.7	22.6	21.3
Incr Delay (d2), s/veh	0.3	0.6	0.1	0.1	1.1	1.2	3.1	1.6	1.6	9.7	0.3	0.2
Initial Q Delay(d3),s/veh	0.0	0.0	0.0	0.0	0.0	0.0	0.0	0.0	0.0	0.0	0.0	0.0
%ile BackOfQ(50%),veh/ln	1.8	3.3	0.4	0.4	4.4	4.5	1.7	6.5	6.5	2.5	3.6	1.5
LnGrp Delay(d),s/veh	27.6	29.1	26.3	23.1	27.3	27.5	38.7	26.5	26.6	45.5	22.9	21.5
LnGrp LOS	C	C	C	C	C	C	D	C	C	D	C	C
Approach Vol, veh/h		546			482			810			591	
Approach Delay, s/veh		28.5			27.2			28.8			26.5	
Approach LOS		C			C			C			C	
Timer	1	2	3	4	5	6	7	8				
Assigned Phs	1	2		4	5	6		8				
Phs Duration (G+Y+Rc), s	9.7	27.1		18.9	9.4	27.5		22.7				
Change Period (Y+Rc), s	4.0	5.0		4.0	4.0	5.0		4.0				
Max Green Setting (Gmax), s	13.0	33.0		25.0	10.0	36.0		25.0				
Max Q Clear Time (g_c+I1), s	6.4	15.2		8.7	5.4	9.4		11.2				
Green Ext Time (p_c), s	0.1	4.1		2.8	0.2	3.3		2.5				
Intersection Summary												
HCM 2010 Ctrl Delay				27.8								
HCM 2010 LOS				C								


















7: Broadway & Embarcadero W
 HCM 2010 Signalized Intersection Summary

03/14/2019

												
Movement	EBL	EBT	EBR	WBL	WBT	WBR	NBL	NBT	NBR	SBL	SBT	SBR
Lane Configurations												
Traffic Volume (veh/h)	9	32	6	99	72	169	2	9	28	63	19	7
Future Volume (veh/h)	9	32	6	99	72	169	2	9	28	63	19	7
Number	7	4	14	3	8	18	5	2	12	1	6	16
Initial Q (Qb), veh	0	0	0	0	0	0	0	0	0	0	0	0
Ped-Bike Adj(A_pbT)	1.00		0.98	0.99		0.97	0.96		0.94	0.96		0.93
Parking Bus, Adj	1.00	1.00	1.00	1.00	1.00	1.00	1.00	1.00	1.00	1.00	1.00	1.00
Adj Sat Flow, veh/h/ln	1710	1487	1710	1710	1487	1710	1710	1487	1710	1710	1487	1710
Adj Flow Rate, veh/h	9	32	6	99	72	169	2	9	28	63	19	7
Adj No. of Lanes	0	1	0	0	1	0	0	1	0	0	2	0
Peak Hour Factor	1.00	1.00	1.00	1.00	1.00	1.00	1.00	1.00	1.00	1.00	1.00	1.00
Percent Heavy Veh, %	15	15	15	15	15	15	15	15	15	15	15	15
Cap, veh/h	159	469	81	219	157	288	75	126	335	528	344	127
Arrive On Green	0.46	0.46	0.46	0.46	0.46	0.46	0.37	0.37	0.37	0.37	0.37	0.37
Sat Flow, veh/h	175	1013	174	290	338	621	16	338	899	1065	923	340
Grp Volume(v), veh/h	47	0	0	340	0	0	39	0	0	63	0	26
Grp Sat Flow(s),veh/h/ln	1361	0	0	1248	0	0	1252	0	0	1065	0	1264
Q Serve(g_s), s	0.0	0.0	0.0	5.9	0.0	0.0	0.0	0.0	0.0	0.7	0.0	0.7
Cycle Q Clear(g_c), s	1.0	0.0	0.0	10.7	0.0	0.0	1.1	0.0	0.0	1.9	0.0	0.7
Prop In Lane	0.19		0.13	0.29		0.50	0.05		0.72	1.00		0.27
Lane Grp Cap(c), veh/h	709	0	0	663	0	0	536	0	0	528	0	471
V/C Ratio(X)	0.07	0.00	0.00	0.51	0.00	0.00	0.07	0.00	0.00	0.12	0.00	0.06
Avail Cap(c_a), veh/h	709	0	0	663	0	0	536	0	0	528	0	471
HCM Platoon Ratio	1.00	1.00	1.00	1.00	1.00	1.00	1.00	1.00	1.00	1.00	1.00	1.00
Upstream Filter(I)	1.00	0.00	0.00	1.00	0.00	0.00	1.00	0.00	0.00	1.00	0.00	1.00
Uniform Delay (d), s/veh	8.2	0.0	0.0	10.7	0.0	0.0	11.2	0.0	0.0	11.4	0.0	11.0
Incr Delay (d2), s/veh	0.2	0.0	0.0	2.8	0.0	0.0	0.3	0.0	0.0	0.5	0.0	0.2
Initial Q Delay(d3),s/veh	0.0	0.0	0.0	0.0	0.0	0.0	0.0	0.0	0.0	0.0	0.0	0.0
%ile BackOfQ(50%),veh/ln	0.4	0.0	0.0	4.2	0.0	0.0	0.4	0.0	0.0	0.7	0.0	0.3
LnGrp Delay(d),s/veh	8.4	0.0	0.0	13.5	0.0	0.0	11.4	0.0	0.0	11.8	0.0	11.3
LnGrp LOS	A			B			B			B		B
Approach Vol, veh/h		47			340			39				89
Approach Delay, s/veh		8.4			13.5			11.4				11.7
Approach LOS		A			B			B				B
Timer	1	2	3	4	5	6	7	8				
Assigned Phs		2		4		6		8				
Phs Duration (G+Y+Rc), s		25.0		30.0		25.0		30.0				
Change Period (Y+Rc), s		4.5		4.5		4.5		4.5				
Max Green Setting (Gmax), s		20.5		25.5		20.5		25.5				
Max Q Clear Time (g_c+I1), s		3.1		3.0		3.9		12.7				
Green Ext Time (p_c), s		0.1		0.2		0.4		1.8				
Intersection Summary												
HCM 2010 Ctrl Delay				12.6								
HCM 2010 LOS				B								






















8: Oak St & 5th Street
 HCM 2010 Signalized Intersection Summary

03/14/2019

												
Movement	EBL	EBT	EBR	WBL	WBT	WBR	NBL	NBT	NBR	SBL	SBT	SBR
Lane Configurations		 										
Traffic Volume (veh/h)	291	485	193	0	0	0	0	389	61	2	47	0
Future Volume (veh/h)	291	485	193	0	0	0	0	389	61	2	47	0
Number	7	4	14				5	2	12	1	6	16
Initial Q (Qb), veh	0	0	0				0	0	0	0	0	0
Ped-Bike Adj(A_pbT)	1.00		0.99				1.00		0.97	1.00		1.00
Parking Bus, Adj	1.00	1.00	1.00				1.00	1.00	1.00	1.00	1.00	1.00
Adj Sat Flow, veh/h/ln	1629	1629	1710				0	1629	1710	1710	1629	0
Adj Flow Rate, veh/h	291	485	193				0	389	61	2	47	0
Adj No. of Lanes	1	2	0				0	1	0	0	1	0
Peak Hour Factor	1.00	1.00	1.00				1.00	1.00	1.00	1.00	1.00	1.00
Percent Heavy Veh, %	5	5	5				0	5	5	5	5	0
Cap, veh/h	426	593	234				0	816	128	67	946	0
Arrive On Green	0.27	0.27	0.27				0.00	0.60	0.60	0.60	0.60	0.00
Sat Flow, veh/h	1551	2160	854				0	1367	214	22	1584	0
Grp Volume(v), veh/h	291	346	332				0	0	450	49	0	0
Grp Sat Flow(s),veh/h/ln	1551	1547	1467				0	0	1582	1607	0	0
Q Serve(g_s), s	11.7	14.7	14.8				0.0	0.0	11.2	0.0	0.0	0.0
Cycle Q Clear(g_c), s	11.7	14.7	14.8				0.0	0.0	11.2	0.9	0.0	0.0
Prop In Lane	1.00		0.58				0.00		0.14	0.04		0.00
Lane Grp Cap(c), veh/h	426	425	403				0	0	944	1013	0	0
V/C Ratio(X)	0.68	0.82	0.82				0.00	0.00	0.48	0.05	0.00	0.00
Avail Cap(c_a), veh/h	565	564	534				0	0	944	1013	0	0
HCM Platoon Ratio	1.00	1.00	1.00				1.00	1.00	1.00	1.00	1.00	1.00
Upstream Filter(I)	1.00	1.00	1.00				0.00	0.00	1.00	1.00	0.00	0.00
Uniform Delay (d), s/veh	22.7	23.7	23.8				0.0	0.0	7.9	5.9	0.0	0.0
Incr Delay (d2), s/veh	1.0	5.2	5.9				0.0	0.0	1.7	0.1	0.0	0.0
Initial Q Delay(d3),s/veh	0.0	0.0	0.0				0.0	0.0	0.0	0.0	0.0	0.0
%ile BackOfQ(50%),veh/ln	5.1	6.9	6.6				0.0	0.0	5.3	0.4	0.0	0.0
LnGrp Delay(d),s/veh	23.7	28.9	29.7				0.0	0.0	9.7	6.0	0.0	0.0
LnGrp LOS	C	C	C						A	A		
Approach Vol, veh/h		969						450			49	
Approach Delay, s/veh		27.6						9.7			6.0	
Approach LOS		C						A			A	
Timer	1	2	3	4	5	6	7	8				
Assigned Phs		2		4		6						
Phs Duration (G+Y+Rc), s		46.3		23.7		46.3						
Change Period (Y+Rc), s		4.5		4.5		4.5						
Max Green Setting (Gmax), s		35.5		25.5		35.5						
Max Q Clear Time (g_c+I1), s		13.2		16.8		2.9						
Green Ext Time (p_c), s		1.9		2.4		0.1						
Intersection Summary												
HCM 2010 Ctrl Delay			21.4									
HCM 2010 LOS			C									













9: Harrison St & Grand Ave
 HCM 2010 Signalized Intersection Summary

03/14/2019

												
Movement	EBL	EBT	EBR	WBL	WBT	WBR	NBL	NBT	NBR	SBL	SBT	SBR
Lane Configurations												
Traffic Volume (veh/h)	74	213	52	274	568	120	53	458	261	13	466	149
Future Volume (veh/h)	74	213	52	274	568	120	53	458	261	13	466	149
Number	3	8	18	7	4	14	5	2	12	1	6	16
Initial Q (Qb), veh	0	0	0	0	0	0	0	0	0	0	0	0
Ped-Bike Adj(A_pbT)	1.00		0.75	1.00		0.81	0.90		1.00	0.89		0.74
Parking Bus, Adj	1.00	1.00	1.00	1.00	1.00	1.00	1.00	1.00	1.00	1.00	1.00	1.00
Adj Sat Flow, veh/h/ln	1845	1845	1845	1845	1845	1900	1900	1845	1845	1900	1845	1845
Adj Flow Rate, veh/h	74	213	24	274	568	120	53	458	0	13	466	34
Adj No. of Lanes	2	2	1	2	2	0	0	3	1	0	2	1
Peak Hour Factor	1.00	1.00	1.00	1.00	1.00	1.00	1.00	1.00	1.00	1.00	1.00	1.00
Percent Heavy Veh, %	3	3	3	3	3	3	3	3	3	3	3	3
Cap, veh/h	160	1184	398	576	1319	277	143	1160	481	53	1030	355
Arrive On Green	0.05	0.34	0.34	0.17	0.48	0.48	0.31	0.31	0.00	0.31	0.31	0.31
Sat Flow, veh/h	3408	3505	1178	3408	2761	579	288	3785	1568	35	3360	1159
Grp Volume(v), veh/h	74	213	24	274	359	329	145	366	0	255	224	34
Grp Sat Flow(s),veh/h/ln	1704	1752	1178	1704	1752	1587	1018	1528	1568	1801	1595	1159
Q Serve(g_s), s	1.9	3.9	1.2	6.5	12.1	12.3	3.7	8.5	0.0	0.0	10.2	1.9
Cycle Q Clear(g_c), s	1.9	3.9	1.2	6.5	12.1	12.3	13.9	8.5	0.0	10.0	10.2	1.9
Prop In Lane	1.00		1.00	1.00		0.36	0.37		1.00	0.05		1.00
Lane Grp Cap(c), veh/h	160	1184	398	576	837	758	367	937	481	594	489	355
V/C Ratio(X)	0.46	0.18	0.06	0.48	0.43	0.43	0.39	0.39	0.00	0.43	0.46	0.10
Avail Cap(c_a), veh/h	189	1184	398	576	837	758	420	1066	547	668	556	404
HCM Platoon Ratio	1.00	1.00	1.00	1.00	1.00	1.00	1.00	1.00	1.00	1.00	1.00	1.00
Upstream Filter(I)	1.00	1.00	1.00	1.00	1.00	1.00	1.00	1.00	0.00	1.00	1.00	1.00
Uniform Delay (d), s/veh	41.8	21.0	20.1	33.8	15.4	15.5	25.7	24.6	0.0	25.1	25.2	22.3
Incr Delay (d2), s/veh	2.1	0.3	0.3	0.6	1.6	1.8	0.7	0.3	0.0	0.5	0.7	0.1
Initial Q Delay(d3),s/veh	0.0	0.0	0.0	0.0	0.0	0.0	0.0	0.0	0.0	0.0	0.0	0.0
%ile BackOfQ(50%),veh/ln	0.9	1.9	0.4	3.1	6.2	5.8	3.1	3.6	0.0	5.2	4.6	0.6
LnGrp Delay(d),s/veh	43.9	21.3	20.4	34.4	17.0	17.3	26.4	24.9	0.0	25.6	25.8	22.4
LnGrp LOS	D	C	C	C	B	B	C	C		C	C	C
Approach Vol, veh/h		311			962			511			513	
Approach Delay, s/veh		26.6			22.1			25.3			25.5	
Approach LOS		C			C			C			C	
Timer	1	2	3	4	5	6	7	8				
Assigned Phs		2	3	4		6	7	8				
Phs Duration (G+Y+Rc), s		33.2	8.2	48.6		33.2	20.8	36.0				
Change Period (Y+Rc), s		5.6	4.0	5.6		5.6	5.6	* 5.6				
Max Green Setting (Gmax), s		31.4	5.0	38.4		31.4	13.0	* 30				
Max Q Clear Time (g_c+I1), s		15.9	3.9	14.3		12.2	8.5	5.9				
Green Ext Time (p_c), s		3.1	0.0	4.7		2.9	0.4	1.4				
Intersection Summary												
HCM 2010 Ctrl Delay			24.2									
HCM 2010 LOS			C									
Notes												



















10: Lakeshore Ave & Foothill Blvd
 HCM 2010 Signalized Intersection Summary

03/14/2019

								
Movement	WBL	WBR	NBT	NBR	SBL	SBT		
Lane Configurations	 		 			 		
Traffic Volume (veh/h)	194	163	491	0	0	1003		
Future Volume (veh/h)	194	163	491	0	0	1003		
Number	3	18	2	12	1	6		
Initial Q (Qb), veh	0	0	0	0	0	0		
Ped-Bike Adj(A_pbT)	1.00	1.00		1.00	1.00			
Parking Bus, Adj	1.00	1.00	1.00	1.00	1.00	1.00		
Adj Sat Flow, veh/h/ln	1863	1900	1863	0	0	1863		
Adj Flow Rate, veh/h	178	180	491	0	0	1003		
Adj No. of Lanes	1	1	2	0	0	2		
Peak Hour Factor	1.00	1.00	1.00	1.00	1.00	1.00		
Percent Heavy Veh, %	2	0	2	0	0	2		
Cap, veh/h	234	213	2783	0	0	2783		
Arrive On Green	0.13	0.13	0.79	0.00	0.00	0.79		
Sat Flow, veh/h	1774	1615	3725	0	0	3725		
Grp Volume(v), veh/h	178	180	491	0	0	1003		
Grp Sat Flow(s),veh/h/ln	1774	1615	1770	0	0	1770		
Q Serve(g_s), s	10.6	12.0	3.8	0.0	0.0	9.3		
Cycle Q Clear(g_c), s	10.6	12.0	3.8	0.0	0.0	9.3		
Prop In Lane	1.00	1.00		0.00	0.00			
Lane Grp Cap(c), veh/h	234	213	2783	0	0	2783		
V/C Ratio(X)	0.76	0.84	0.18	0.00	0.00	0.36		
Avail Cap(c_a), veh/h	540	492	2783	0	0	2783		
HCM Platoon Ratio	1.00	1.00	1.00	1.00	1.00	1.00		
Upstream Filter(I)	1.00	1.00	1.00	0.00	0.00	1.00		
Uniform Delay (d), s/veh	46.1	46.6	2.9	0.0	0.0	3.5		
Incr Delay (d2), s/veh	1.9	3.5	0.1	0.0	0.0	0.4		
Initial Q Delay(d3),s/veh	0.0	0.0	0.0	0.0	0.0	0.0		
%ile BackOfQ(50%),veh/ln	5.4	5.6	1.9	0.0	0.0	4.6		
LnGrp Delay(d),s/veh	48.0	50.2	3.1	0.0	0.0	3.9		
LnGrp LOS	D	D	A			A		
Approach Vol, veh/h	358		491			1003		
Approach Delay, s/veh	49.1		3.1			3.9		
Approach LOS	D		A			A		
Timer	1	2	3	4	5	6	7	8
Assigned Phs		2				6		8
Phs Duration (G+Y+Rc), s		91.0				91.0		19.0
Change Period (Y+Rc), s		4.5				4.5		4.5
Max Green Setting (Gmax), s		67.5				67.5		33.5
Max Q Clear Time (g_c+I1), s		5.8				11.3		14.0
Green Ext Time (p_c), s		2.6				6.3		0.5
Intersection Summary								
HCM 2010 Ctrl Delay			12.4					
HCM 2010 LOS			B					
Notes								





















11: Lakeshore Ave & MacArthur Blvd
 HCM 2010 Signalized Intersection Summary

03/14/2019

												
Movement	EBL	EBT	EBR	WBL	WBT	WBR	NBL	NBT	NBR	SBL	SBT	SBR
Lane Configurations												
Traffic Volume (veh/h)	245	659	169	0	0	0	0	492	249	288	454	0
Future Volume (veh/h)	245	659	169	0	0	0	0	492	249	288	454	0
Number	7	4	14				5	2	12	1	6	16
Initial Q (Qb), veh	0	0	0				0	0	0	0	0	0
Ped-Bike Adj(A_pbT)	1.00		0.89				1.00		0.96	1.00		1.00
Parking Bus, Adj	1.00	1.00	1.00				1.00	1.00	1.00	1.00	1.00	1.00
Adj Sat Flow, veh/h/ln	1863	1863	1863				0	1863	1900	1863	1863	0
Adj Flow Rate, veh/h	226	686	103				0	492	249	288	454	0
Adj No. of Lanes	1	3	1				0	2	0	1	2	0
Peak Hour Factor	1.00	1.00	1.00				1.00	1.00	1.00	1.00	1.00	1.00
Percent Heavy Veh, %	2	2	2				0	2	2	2	2	0
Cap, veh/h	422	1329	337				0	743	374	549	2397	0
Arrive On Green	0.24	0.24	0.24				0.00	0.33	0.33	0.41	0.90	0.00
Sat Flow, veh/h	1774	5588	1416				0	2342	1131	1774	3632	0
Grp Volume(v), veh/h	226	686	103				0	387	354	288	454	0
Grp Sat Flow(s),veh/h/ln	1774	1863	1416				0	1770	1610	1774	1770	0
Q Serve(g_s), s	11.8	11.3	6.3				0.0	19.8	20.0	12.9	1.6	0.0
Cycle Q Clear(g_c), s	11.8	11.3	6.3				0.0	19.8	20.0	12.9	1.6	0.0
Prop In Lane	1.00		1.00				0.00		0.70	1.00		0.00
Lane Grp Cap(c), veh/h	422	1329	337				0	584	532	549	2397	0
V/C Ratio(X)	0.54	0.52	0.31				0.00	0.66	0.67	0.52	0.19	0.00
Avail Cap(c_a), veh/h	502	1582	401				0	584	532	549	2397	0
HCM Platoon Ratio	1.00	1.00	1.00				1.00	1.00	1.00	1.33	1.33	1.00
Upstream Filter(I)	1.00	1.00	1.00				0.00	1.00	1.00	0.64	0.64	0.00
Uniform Delay (d), s/veh	35.3	35.1	33.2				0.0	30.4	30.5	25.4	1.8	0.0
Incr Delay (d2), s/veh	0.4	0.1	0.2				0.0	5.8	6.5	0.3	0.1	0.0
Initial Q Delay(d3),s/veh	0.0	0.0	0.0				0.0	0.0	0.0	0.0	0.0	0.0
%ile BackOfQ(50%),veh/ln	5.8	5.8	2.5				0.0	10.6	9.8	6.3	0.8	0.0
LnGrp Delay(d),s/veh	35.7	35.2	33.4				0.0	36.2	37.0	25.6	1.9	0.0
LnGrp LOS	D	D	C					D	D	C	A	
Approach Vol, veh/h		1015						741			742	
Approach Delay, s/veh		35.1						36.6			11.1	
Approach LOS		D						D			B	
Timer	1	2	3	4	5	6	7	8				
Assigned Phs	1	2		4		6						
Phs Duration (G+Y+Rc), s	36.8	39.0		30.2		75.8						
Change Period (Y+Rc), s	4.0	* 4		5.0		4.0						
Max Green Setting (Gmax), s	28.5	* 35		30.0		67.0						
Max Q Clear Time (g_c+I1), s	14.9	22.0		13.8		3.6						
Green Ext Time (p_c), s	0.4	2.9		3.5		2.3						
Intersection Summary												
HCM 2010 Ctrl Delay			28.4									
HCM 2010 LOS			C									
Notes												

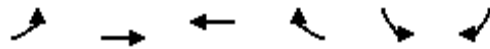
12: Lakeshore Ave & Lake Park Ave
 HCM 2010 Signalized Intersection Summary

03/14/2019

												
Movement	EBL	EBT	EBR	WBL	WBT	WBR	NBL	NBT	NBR	SBL	SBT	SBR
Lane Configurations												
Traffic Volume (veh/h)	39	0	54	352	641	191	334	400	0	0	344	235
Future Volume (veh/h)	39	0	54	352	641	191	334	400	0	0	344	235
Number	7	4	14	3	8	18	5	2	12	1	6	16
Initial Q (Qb), veh	0	0	0	0	0	0	0	0	0	0	0	0
Ped-Bike Adj(A_pbT)	1.00		0.98	1.00		1.00	1.00		1.00	1.00		0.77
Parking Bus, Adj	1.00	1.00	1.00	1.00	1.00	1.00	1.00	1.00	1.00	1.00	1.00	1.00
Adj Sat Flow, veh/h/ln	1863	1863	1900	1900	1863	1863	1863	1863	0	0	1863	1900
Adj Flow Rate, veh/h	39	0	54	352	641	0	334	400	0	0	344	235
Adj No. of Lanes	1	1	0	0	2	1	2	1	0	0	2	0
Peak Hour Factor	1.00	1.00	1.00	1.00	1.00	1.00	1.00	1.00	1.00	1.00	1.00	1.00
Percent Heavy Veh, %	2	2	2	2	2	2	2	2	0	0	2	2
Cap, veh/h	110	0	96	456	891	597	434	781	0	0	460	298
Arrive On Green	0.06	0.00	0.06	0.38	0.38	0.00	0.25	0.84	0.00	0.00	0.25	0.25
Sat Flow, veh/h	1774	0	1548	1210	2362	1583	3442	1863	0	0	1925	1186
Grp Volume(v), veh/h	39	0	54	524	469	0	334	400	0	0	332	247
Grp Sat Flow(s),veh/h/ln	1774	0	1548	1802	1770	1583	1721	1863	0	0	1770	1248
Q Serve(g_s), s	2.2	0.0	3.6	27.1	23.8	0.0	9.5	6.4	0.0	0.0	18.3	19.6
Cycle Q Clear(g_c), s	2.2	0.0	3.6	27.1	23.8	0.0	9.5	6.4	0.0	0.0	18.3	19.6
Prop In Lane	1.00		1.00	0.67		1.00	1.00		0.00	0.00		0.95
Lane Grp Cap(c), veh/h	110	0	96	680	668	597	434	781	0	0	444	313
V/C Ratio(X)	0.36	0.00	0.56	0.77	0.70	0.00	0.77	0.51	0.00	0.00	0.75	0.79
Avail Cap(c_a), veh/h	117	0	102	680	668	597	435	781	0	0	444	313
HCM Platoon Ratio	1.00	1.00	1.00	1.00	1.00	1.00	2.00	2.00	1.00	1.00	1.00	1.00
Upstream Filter(I)	1.00	0.00	1.00	1.00	1.00	0.00	0.80	0.80	0.00	0.00	1.00	1.00
Uniform Delay (d), s/veh	47.7	0.0	48.3	29.0	27.9	0.0	38.2	5.5	0.0	0.0	36.6	37.1
Incr Delay (d2), s/veh	0.7	0.0	3.2	8.3	6.1	0.0	6.0	1.9	0.0	0.0	10.9	18.1
Initial Q Delay(d3),s/veh	0.0	0.0	0.0	0.0	0.0	0.0	0.0	0.0	0.0	0.0	0.0	0.0
%ile BackOfQ(50%),veh/ln	1.1	0.0	1.6	15.0	12.7	0.0	4.9	3.5	0.0	0.0	10.3	8.3
LnGrp Delay(d),s/veh	48.4	0.0	51.5	37.2	34.0	0.0	44.2	7.4	0.0	0.0	47.5	55.2
LnGrp LOS	D		D	D	C		D	A			D	E
Approach Vol, veh/h		93			993			734			579	
Approach Delay, s/veh		50.2			35.7			24.2			50.8	
Approach LOS		D			D			C			D	
Timer	1	2	3	4	5	6	7	8				
Assigned Phs		2		4	5	6		8				
Phs Duration (G+Y+Rc), s		49.0		12.0	17.9	31.1		45.0				
Change Period (Y+Rc), s		4.5		5.5	4.5	* 4.5		5.0				
Max Green Setting (Gmax), s		44.0		7.0	13.4	* 27		40.0				
Max Q Clear Time (g_c+I1), s		8.4		5.6	11.5	21.6		29.1				
Green Ext Time (p_c), s		1.8		0.0	0.2	1.3		3.4				
Intersection Summary												
HCM 2010 Ctrl Delay			36.4									
HCM 2010 LOS			D									
Notes												

13: Embarcadero W & 880 On-Ramp
 HCM 2010 Signalized Intersection Summary
























03/14/2019



Movement	EBL	EBT	WBT	WBR	SBL	SBR		
Lane Configurations								
Traffic Volume (veh/h)	702	359	457	101	0	0		
Future Volume (veh/h)	702	359	457	101	0	0		
Number	7	4	8	18				
Initial Q (Qb), veh	0	0	0	0				
Ped-Bike Adj(A_pbT)	1.00			1.00				
Parking Bus, Adj	1.00	1.00	1.00	1.00				
Adj Sat Flow, veh/h/ln	1827	1827	1827	1900				
Adj Flow Rate, veh/h	702	359	457	0				
Adj No. of Lanes	1	2	1	0				
Peak Hour Factor	1.00	1.00	1.00	1.00				
Percent Heavy Veh, %	4	4	4	4				
Cap, veh/h	726	3298	882	0				
Arrive On Green	0.70	1.00	0.48	0.00				
Sat Flow, veh/h	1740	3563	1827	0				
Grp Volume(v), veh/h	702	359	457	0				
Grp Sat Flow(s),veh/h/ln	1740	1736	1827	0				
Q Serve(g_s), s	33.7	0.0	15.5	0.0				
Cycle Q Clear(g_c), s	33.7	0.0	15.5	0.0				
Prop In Lane	1.00			0.00				
Lane Grp Cap(c), veh/h	726	3298	882	0				
V/C Ratio(X)	0.97	0.11	0.52	0.00				
Avail Cap(c_a), veh/h	860	3298	882	0				
HCM Platoon Ratio	1.67	1.67	1.00	1.00				
Upstream Filter(I)	1.00	1.00	1.00	0.00				
Uniform Delay (d), s/veh	13.0	0.0	16.1	0.0				
Incr Delay (d2), s/veh	21.2	0.1	2.2	0.0				
Initial Q Delay(d3),s/veh	0.0	0.0	0.0	0.0				
%ile BackOfQ(50%),veh/ln	19.9	0.0	8.3	0.0				
LnGrp Delay(d),s/veh	34.2	0.1	18.2	0.0				
LnGrp LOS	C	A	B					
Approach Vol, veh/h		1061	457					
Approach Delay, s/veh		22.7	18.2					
Approach LOS		C	B					
Timer	1	2	3	4	5	6	7	8
Assigned Phs				4			7	8
Phs Duration (G+Y+Rc), s				90.0			42.1	47.9
Change Period (Y+Rc), s				4.5			4.5	4.5
Max Green Setting (Gmax), s				85.5			44.5	36.5
Max Q Clear Time (g_c+I1), s				2.0			35.7	17.5
Green Ext Time (p_c), s				2.7			1.9	2.8
Intersection Summary								
HCM 2010 Ctrl Delay			21.3					
HCM 2010 LOS			C					



















14: 5th Ave & E 8th St
 HCM 2010 Signalized Intersection Summary

03/14/2019

												
Movement	EBL	EBT	EBR	WBL	WBT	WBR	NBL	NBT	NBR	SBL	SBT	SBR
Lane Configurations												
Traffic Volume (veh/h)	82	206	73	104	527	1	161	320	138	7	350	142
Future Volume (veh/h)	82	206	73	104	527	1	161	320	138	7	350	142
Number	7	4	14	3	8	18	5	2	12	1	6	16
Initial Q (Qb), veh	0	0	0	0	0	0	0	0	0	0	0	0
Ped-Bike Adj(A_pbT)	1.00		0.97	0.99		0.96	1.00		0.98	1.00		0.98
Parking Bus, Adj	1.00	1.00	1.00	1.00	1.00	1.00	1.00	1.00	1.00	1.00	1.00	1.00
Adj Sat Flow, veh/h/ln	1845	1845	1845	1845	1845	1900	1845	1845	1845	1845	1845	1845
Adj Flow Rate, veh/h	82	206	31	104	527	1	161	320	64	7	350	66
Adj No. of Lanes	1	3	1	1	2	0	1	1	1	1	1	1
Peak Hour Factor	1.00	1.00	1.00	1.00	1.00	1.00	1.00	1.00	1.00	1.00	1.00	1.00
Percent Heavy Veh, %	3	3	3	3	3	3	3	3	3	3	3	3
Cap, veh/h	245	1421	427	391	1013	2	607	1129	943	631	1129	943
Arrive On Green	0.28	0.28	0.28	0.28	0.28	0.28	0.61	0.61	0.61	0.61	0.61	0.61
Sat Flow, veh/h	860	5036	1514	1119	3589	7	956	1845	1541	985	1845	1542
Grp Volume(v), veh/h	82	206	31	104	257	271	161	320	64	7	350	66
Grp Sat Flow(s),veh/h/ln	860	1679	1514	1119	1752	1843	956	1845	1541	985	1845	1542
Q Serve(g_s), s	5.9	2.0	1.0	5.1	8.2	8.2	6.4	5.4	1.1	0.2	6.0	1.1
Cycle Q Clear(g_c), s	14.0	2.0	1.0	7.1	8.2	8.2	12.4	5.4	1.1	5.6	6.0	1.1
Prop In Lane	1.00		1.00	1.00		0.00	1.00		1.00	1.00		1.00
Lane Grp Cap(c), veh/h	245	1421	427	391	494	520	607	1129	943	631	1129	943
V/C Ratio(X)	0.33	0.14	0.07	0.27	0.52	0.52	0.27	0.28	0.07	0.01	0.31	0.07
Avail Cap(c_a), veh/h	374	2175	654	558	757	796	607	1129	943	631	1129	943
HCM Platoon Ratio	1.00	1.00	1.00	1.00	1.00	1.00	1.00	1.00	1.00	1.00	1.00	1.00
Upstream Filter(I)	1.00	1.00	1.00	1.00	1.00	1.00	1.00	1.00	1.00	1.00	1.00	1.00
Uniform Delay (d), s/veh	25.8	17.7	17.4	20.4	19.9	19.9	9.1	6.0	5.2	7.3	6.1	5.2
Incr Delay (d2), s/veh	0.8	0.0	0.1	0.4	0.9	0.8	1.1	0.6	0.1	0.0	0.7	0.1
Initial Q Delay(d3),s/veh	0.0	0.0	0.0	0.0	0.0	0.0	0.0	0.0	0.0	0.0	0.0	0.0
%ile BackOfQ(50%),veh/ln	1.4	0.9	0.4	1.6	4.0	4.3	1.8	2.9	0.5	0.1	3.2	0.5
LnGrp Delay(d),s/veh	26.6	17.8	17.4	20.7	20.8	20.7	10.2	6.6	5.3	7.4	6.9	5.3
LnGrp LOS	C	B	B	C	C	C	B	A	A	A	A	A
Approach Vol, veh/h		319			632			545			423	
Approach Delay, s/veh		20.0			20.8			7.5			6.6	
Approach LOS		C			C			A			A	
Timer	1	2	3	4	5	6	7	8				
Assigned Phs		2		4		6		8				
Phs Duration (G+Y+Rc), s		43.9		22.1		43.9		22.1				
Change Period (Y+Rc), s		3.5		3.5		3.5		3.5				
Max Green Setting (Gmax), s		31.0		28.5		31.0		28.5				
Max Q Clear Time (g_c+I1), s		14.4		16.0		8.0		10.2				
Green Ext Time (p_c), s		2.8		1.5		2.4		3.3				
Intersection Summary												
HCM 2010 Ctrl Delay			13.8									
HCM 2010 LOS			B									

15: E 8th St/14th Ave & E 12th St
 HCM 2010 Signalized Intersection Summary

03/14/2019

												
Movement	EBL	EBT	EBR	WBL	WBT	WBR	NBL	NBT	NBR	SBL	SBT	SBR
Lane Configurations												
Traffic Volume (veh/h)	106	144	7	0	0	0	0	178	0	244	302	0
Future Volume (veh/h)	106	144	7	0	0	0	0	178	0	244	302	0
Number	1	6	16				7	4	14	3	8	18
Initial Q (Qb), veh	0	0	0				0	0	0	0	0	0
Ped-Bike Adj(A_pbT)	1.00		1.00				1.00		1.00	1.00		1.00
Parking Bus, Adj	1.00	1.00	1.00				1.00	1.00	1.00	1.00	1.00	1.00
Adj Sat Flow, veh/h/ln	1863	1863	1900				0	1863	0	1863	1863	0
Adj Flow Rate, veh/h	106	144	0				0	178	0	244	302	0
Adj No. of Lanes	1	2	0				0	2	0	1	3	0
Peak Hour Factor	1.00	1.00	1.00				1.00	1.00	1.00	1.00	1.00	1.00
Percent Heavy Veh, %	2	2	2				0	2	0	2	2	0
Cap, veh/h	491	980	0				0	817	0	858	2895	0
Arrive On Green	0.28	0.28	0.00				0.00	0.23	0.00	0.29	0.57	0.00
Sat Flow, veh/h	1774	3632	0				0	3725	0	1774	5253	0
Grp Volume(v), veh/h	106	144	0				0	178	0	244	302	0
Grp Sat Flow(s),veh/h/ln	1774	1770	0				0	1770	0	1774	1695	0
Q Serve(g_s), s	3.0	2.0	0.0				0.0	2.6	0.0	4.6	1.8	0.0
Cycle Q Clear(g_c), s	3.0	2.0	0.0				0.0	2.6	0.0	4.6	1.8	0.0
Prop In Lane	1.00		0.00				0.00		0.00	1.00		0.00
Lane Grp Cap(c), veh/h	491	980	0				0	817	0	858	2895	0
V/C Ratio(X)	0.22	0.15	0.00				0.00	0.22	0.00	0.28	0.10	0.00
Avail Cap(c_a), veh/h	491	980	0				0	817	0	858	2895	0
HCM Platoon Ratio	1.00	1.00	1.00				1.00	1.00	1.00	1.00	1.00	1.00
Upstream Filter(I)	1.00	1.00	0.00				0.00	1.00	0.00	1.00	1.00	0.00
Uniform Delay (d), s/veh	18.1	17.7	0.0				0.0	20.2	0.0	7.7	6.4	0.0
Incr Delay (d2), s/veh	1.0	0.3	0.0				0.0	0.6	0.0	0.8	0.1	0.0
Initial Q Delay(d3),s/veh	0.0	0.0	0.0				0.0	0.0	0.0	0.0	0.0	0.0
%ile BackOfQ(50%),veh/ln	1.6	1.0	0.0				0.0	1.4	0.0	2.4	0.8	0.0
LnGrp Delay(d),s/veh	19.1	18.0	0.0				0.0	20.9	0.0	8.5	6.5	0.0
LnGrp LOS	B	B						C		A	A	
Approach Vol, veh/h		250						178			546	
Approach Delay, s/veh		18.5						20.9			7.4	
Approach LOS		B						C			A	
Timer	1	2	3	4	5	6	7	8				
Assigned Phs			3	4		6		8				
Phs Duration (G+Y+Rc), s			22.0	20.0		23.0		42.0				
Change Period (Y+Rc), s			3.0	5.0		5.0		5.0				
Max Green Setting (Gmax), s			19.0	15.0		18.0		37.0				
Max Q Clear Time (g_c+I1), s			6.6	4.6		5.0		3.8				
Green Ext Time (p_c), s			0.0	0.2		0.1		0.5				
Intersection Summary												
HCM 2010 Ctrl Delay			12.7									
HCM 2010 LOS			B									

16: Foothill & 14th Ave
 HCM Signalized Intersection Capacity Analysis

03/14/2019



Movement	EBL	EBT	EBR	WBL	WBT	WBR	NBL	NBT	NBR	SBL	SBT	SBR
Lane Configurations					↕↕						↕↕	
Traffic Volume (vph)	0	0	0	71	297	0	0	0	0	88	908	162
Future Volume (vph)	0	0	0	71	297	0	0	0	0	88	908	162
Ideal Flow (vphpl)	1900	1900	1900	1900	1900	1900	1900	1900	1900	1900	1900	1900
Total Lost time (s)					5.5						4.0	
Lane Util. Factor					0.95						0.95	
Frbp, ped/bikes					1.00						0.99	
Flpb, ped/bikes					1.00						1.00	
Frt					1.00						0.98	
Flt Protected					0.99						1.00	
Satd. Flow (prot)					3505						3434	
Flt Permitted					0.99						1.00	
Satd. Flow (perm)					3505						3434	
Peak-hour factor, PHF	1.00	1.00	1.00	1.00	1.00	1.00	1.00	1.00	1.00	1.00	1.00	1.00
Adj. Flow (vph)	0	0	0	71	297	0	0	0	0	88	908	162
RTOR Reduction (vph)	0	0	0	0	0	0	0	0	0	0	10	0
Lane Group Flow (vph)	0	0	0	0	368	0	0	0	0	0	1148	0
Confl. Peds. (#/hr)	20		12			20	12					12
Confl. Bikes (#/hr)						16						8
Turn Type				Split	NA					Split	NA	
Protected Phases				5	5					6	6	
Permitted Phases												
Actuated Green, G (s)					22.5						67.1	
Effective Green, g (s)					22.5						67.1	
Actuated g/C Ratio					0.19						0.56	
Clearance Time (s)					5.5						4.0	
Vehicle Extension (s)					0.2						0.2	
Lane Grp Cap (vph)					657						1920	
v/s Ratio Prot					c0.10						c0.33	
v/s Ratio Perm												
v/c Ratio					0.56						0.60	
Uniform Delay, d1					44.3						17.5	
Progression Factor					2.01						1.00	
Incremental Delay, d2					0.5						1.4	
Delay (s)					89.3						18.9	
Level of Service					F						B	
Approach Delay (s)		0.0			89.3			0.0			18.9	
Approach LOS		A			F			A			B	
Intersection Summary												
HCM 2000 Control Delay			35.9									HCM 2000 Level of Service D
HCM 2000 Volume to Capacity ratio			0.50									
Actuated Cycle Length (s)			120.0							15.0		Sum of lost time (s)
Intersection Capacity Utilization			54.5%									ICU Level of Service A
Analysis Period (min)			15									
c Critical Lane Group												

17: 14th Ave & Foothill Blvd
 HCM Signalized Intersection Capacity Analysis

03/14/2019



Movement	EBL	EBT	EBR	WBL	WBT	WBR	NBL	NBT	NBR	SBL	SBT	SBR
Lane Configurations		↑↑			↑↑			↑↑				
Traffic Volume (vph)	2	86	0	0	368	1	0	439	104	0	0	0
Future Volume (vph)	2	86	0	0	368	1	0	439	104	0	0	0
Ideal Flow (vphpl)	1900	1900	1900	1900	1900	1900	1900	1900	1900	1900	1900	1900
Total Lost time (s)		5.5			5.5			4.0				
Lane Util. Factor		0.95			0.95			0.95				
Frbp, ped/bikes		1.00			1.00			1.00				
Flpb, ped/bikes		1.00			1.00			1.00				
Frt		1.00			1.00			0.97				
Flt Protected		1.00			1.00			1.00				
Satd. Flow (prot)		3501			3503			3393				
Flt Permitted		0.95			1.00			1.00				
Satd. Flow (perm)		3336			3503			3393				
Peak-hour factor, PHF	1.00	1.00	1.00	1.00	1.00	1.00	1.00	1.00	1.00	1.00	1.00	1.00
Adj. Flow (vph)	2	86	0	0	368	1	0	439	104	0	0	0
RTOR Reduction (vph)	0	0	0	0	0	0	0	15	0	0	0	0
Lane Group Flow (vph)	0	88	0	0	369	0	0	528	0	0	0	0
Confl. Peds. (#/hr)			7	7		17			2	2		
Confl. Bikes (#/hr)			1			13			5			
Heavy Vehicles (%)	3%	3%	3%	3%	3%	3%	3%	3%	3%	3%	3%	3%
Turn Type	custom	NA			NA			NA				
Protected Phases	1	4	1		8			2				
Permitted Phases	4											
Actuated Green, G (s)		21.0			15.4			85.0				
Effective Green, g (s)		21.0			15.4			85.0				
Actuated g/C Ratio		0.18			0.13			0.71				
Clearance Time (s)					5.5			4.0				
Vehicle Extension (s)					0.2			0.2				
Lane Grp Cap (vph)		591			449			2403				
v/s Ratio Prot		c0.01			c0.11			c0.16				
v/s Ratio Perm		0.02										
v/c Ratio		0.15			0.82			0.22				
Uniform Delay, d1		41.9			51.0			6.0				
Progression Factor		1.80			1.00			1.00				
Incremental Delay, d2		0.0			11.0			0.2				
Delay (s)		75.4			62.0			6.3				
Level of Service		E			E			A				
Approach Delay (s)		75.4			62.0			6.3			0.0	
Approach LOS		E			E			A			A	
Intersection Summary												
HCM 2000 Control Delay			32.9					HCM 2000 Level of Service		C		
HCM 2000 Volume to Capacity ratio			0.31									
Actuated Cycle Length (s)			120.0					Sum of lost time (s)		15.0		
Intersection Capacity Utilization			34.2%					ICU Level of Service		A		
Analysis Period (min)			15									
c	Critical Lane Group											

18: 23rd Ave & 16th St
 HCM Signalized Intersection Capacity Analysis












03/14/2019



Movement	WBL	WBR	NBT	NBR	SBL	SBT
Lane Configurations	↔		↑			↓
Traffic Volume (vph)	7	57	211	10	24	392
Future Volume (vph)	7	57	211	10	24	392
Ideal Flow (vphpl)	1900	1900	1900	1900	1900	1900
Total Lost time (s)	4.0		4.0			4.0
Lane Util. Factor	1.00		1.00			1.00
Frbp, ped/bikes	0.97		1.00			1.00
Flpb, ped/bikes	1.00		1.00			1.00
Frt	0.88		0.99			1.00
Flt Protected	0.99		1.00			1.00
Satd. Flow (prot)	1568		1828			1836
Flt Permitted	0.99		1.00			0.98
Satd. Flow (perm)	1568		1828			1803
Peak-hour factor, PHF	1.00	1.00	1.00	1.00	1.00	1.00
Adj. Flow (vph)	7	57	211	10	24	392
RTOR Reduction (vph)	50	0	2	0	0	0
Lane Group Flow (vph)	14	0	219	0	0	416
Confl. Peds. (#/hr)		2		33	33	
Confl. Bikes (#/hr)		1		2		
Heavy Vehicles (%)	3%	3%	3%	3%	3%	3%
Turn Type	Prot		NA		Perm	NA
Protected Phases	7		2			2
Permitted Phases					2	
Actuated Green, G (s)	6.2		27.2			27.2
Effective Green, g (s)	6.2		27.2			27.2
Actuated g/C Ratio	0.12		0.50			0.50
Clearance Time (s)	4.0		4.0			4.0
Vehicle Extension (s)	3.0		3.0			3.0
Lane Grp Cap (vph)	180		922			909
v/s Ratio Prot	c0.01		0.12			
v/s Ratio Perm						c0.23
v/c Ratio	0.08		0.24			0.46
Uniform Delay, d1	21.3		7.5			8.6
Progression Factor	1.00		1.00			0.21
Incremental Delay, d2	0.2		0.1			0.3
Delay (s)	21.5		7.6			2.2
Level of Service	C		A			A
Approach Delay (s)	21.5		7.6			2.2
Approach LOS	C		A			A
Intersection Summary						
HCM 2000 Control Delay			5.6		HCM 2000 Level of Service	A
HCM 2000 Volume to Capacity ratio			0.31			
Actuated Cycle Length (s)			53.9		Sum of lost time (s)	12.0
Intersection Capacity Utilization			50.6%		ICU Level of Service	A
Analysis Period (min)			15			
c Critical Lane Group						












19: 7th Ave & Embarcadero W
 HCM 2010 Signalized Intersection Summary

03/14/2019

								
Movement	EBT	EBR	WBL	WBT	NBL	NBR		
Lane Configurations								
Traffic Volume (veh/h)	971	43	20	547	120	54		
Future Volume (veh/h)	971	43	20	547	120	54		
Number	4	14	3	8	5	12		
Initial Q (Qb), veh	0	0	0	0	0	0		
Ped-Bike Adj(A_pbT)		0.81	0.96		1.00	1.00		
Parking Bus, Adj	1.00	1.00	1.00	1.00	1.00	1.00		
Adj Sat Flow, veh/h/ln	1863	1900	1863	1863	1863	1863		
Adj Flow Rate, veh/h	971	43	20	547	120	23		
Adj No. of Lanes	2	0	1	2	1	1		
Peak Hour Factor	1.00	1.00	1.00	1.00	1.00	1.00		
Percent Heavy Veh, %	2	2	2	2	2	2		
Cap, veh/h	2142	95	413	2222	483	431		
Arrive On Green	1.00	1.00	1.00	1.00	0.27	0.27		
Sat Flow, veh/h	3505	151	531	3632	1774	1583		
Grp Volume(v), veh/h	504	510	20	547	120	23		
Grp Sat Flow(s),veh/h/ln	1770	1794	531	1770	1774	1583		
Q Serve(g_s), s	0.0	0.0	0.0	0.0	4.8	1.0		
Cycle Q Clear(g_c), s	0.0	0.0	0.0	0.0	4.8	1.0		
Prop In Lane		0.08	1.00		1.00	1.00		
Lane Grp Cap(c), veh/h	1111	1126	413	2222	483	431		
V/C Ratio(X)	0.45	0.45	0.05	0.25	0.25	0.05		
Avail Cap(c_a), veh/h	1111	1126	413	2222	483	431		
HCM Platoon Ratio	2.00	2.00	2.00	2.00	1.00	1.00		
Upstream Filter(I)	0.86	0.86	0.94	0.94	1.00	1.00		
Uniform Delay (d), s/veh	0.0	0.0	0.0	0.0	25.6	24.2		
Incr Delay (d2), s/veh	1.2	1.1	0.2	0.2	1.2	0.2		
Initial Q Delay(d3),s/veh	0.0	0.0	0.0	0.0	0.0	0.0		
%ile BackOfQ(50%),veh/ln	0.4	0.4	0.0	0.1	2.5	0.4		
LnGrp Delay(d),s/veh	1.2	1.1	0.2	0.2	26.8	24.4		
LnGrp LOS	A	A	A	A	C	C		
Approach Vol, veh/h	1014			567	143			
Approach Delay, s/veh	1.1			0.2	26.4			
Approach LOS	A			A	C			
Timer	1	2	3	4	5	6	7	8
Assigned Phs		2		4				8
Phs Duration (G+Y+Rc), s		29.0		61.0				61.0
Change Period (Y+Rc), s		4.5		4.5				4.5
Max Green Setting (Gmax), s		24.5		56.5				56.5
Max Q Clear Time (g_c+I1), s		6.8		2.0				2.0
Green Ext Time (p_c), s		0.3		8.6				4.6
Intersection Summary								
HCM 2010 Ctrl Delay			2.9					
HCM 2010 LOS			A					

20: 8th Ave & Embarcadero W
 HCM 2010 Signalized Intersection Summary

03/14/2019

								
Movement	EBT	EBR	WBL	WBT	NBL	NBR		
Lane Configurations								
Traffic Volume (veh/h)	987	38	10	447	120	59		
Future Volume (veh/h)	987	38	10	447	120	59		
Number	4	14	3	8	5	12		
Initial Q (Qb), veh	0	0	0	0	0	0		
Ped-Bike Adj(A_pbT)		1.00	1.00		1.00	1.00		
Parking Bus, Adj	1.00	1.00	1.00	1.00	1.00	1.00		
Adj Sat Flow, veh/h/ln	1863	1900	1863	1863	1863	1863		
Adj Flow Rate, veh/h	987	38	10	447	120	17		
Adj No. of Lanes	2	0	1	1	1	1		
Peak Hour Factor	1.00	1.00	1.00	1.00	1.00	1.00		
Percent Heavy Veh, %	2	2	2	2	2	2		
Cap, veh/h	2143	83	418	1149	503	449		
Arrive On Green	1.00	1.00	1.00	1.00	0.28	0.28		
Sat Flow, veh/h	3568	134	548	1863	1774	1583		
Grp Volume(v), veh/h	503	522	10	447	120	17		
Grp Sat Flow(s),veh/h/ln	1770	1839	548	1863	1774	1583		
Q Serve(g_s), s	0.0	0.0	0.0	0.0	4.7	0.7		
Cycle Q Clear(g_c), s	0.0	0.0	0.0	0.0	4.7	0.7		
Prop In Lane		0.07	1.00		1.00	1.00		
Lane Grp Cap(c), veh/h	1091	1134	418	1149	503	449		
V/C Ratio(X)	0.46	0.46	0.02	0.39	0.24	0.04		
Avail Cap(c_a), veh/h	1091	1134	418	1149	503	449		
HCM Platoon Ratio	2.00	2.00	2.00	2.00	1.00	1.00		
Upstream Filter(I)	0.89	0.89	1.00	1.00	1.00	1.00		
Uniform Delay (d), s/veh	0.0	0.0	0.0	0.0	24.8	23.4		
Incr Delay (d2), s/veh	1.2	1.2	0.1	1.0	1.1	0.2		
Initial Q Delay(d3),s/veh	0.0	0.0	0.0	0.0	0.0	0.0		
%ile BackOfQ(50%),veh/ln	0.4	0.4	0.0	0.3	2.5	0.3		
LnGrp Delay(d),s/veh	1.2	1.2	0.1	1.0	25.9	23.5		
LnGrp LOS	A	A	A	A	C	C		
Approach Vol, veh/h	1025			457	137			
Approach Delay, s/veh	1.2			1.0	25.6			
Approach LOS	A			A	C			
Timer	1	2	3	4	5	6	7	8
Assigned Phs		2		4				8
Phs Duration (G+Y+Rc), s		30.0		60.0				60.0
Change Period (Y+Rc), s		4.5		4.5				4.5
Max Green Setting (Gmax), s		25.5		55.5				55.5
Max Q Clear Time (g_c+I1), s		6.7		2.0				2.0
Green Ext Time (p_c), s		0.3		8.6				3.3
Intersection Summary								
HCM 2010 Ctrl Delay			3.2					
HCM 2010 LOS			A					

Intersection						
Int Delay, s/veh	0.9					
Movement	EBT	EBR	WBL	WBT	NBL	NBR
Lane Configurations	↑↑			↑		↑
Traffic Vol, veh/h	1012	34	0	457	0	58
Future Vol, veh/h	1012	34	0	457	0	58
Conflicting Peds, #/hr	0	270	0	0	0	0
Sign Control	Free	Free	Free	Free	Stop	Stop
RT Channelized	-	None	-	None	-	None
Storage Length	-	-	-	-	-	0
Veh in Median Storage, #	0	-	-	0	0	-
Grade, %	0	-	-	0	0	-
Peak Hour Factor	100	100	100	100	100	100
Heavy Vehicles, %	2	2	2	2	2	2
Mvmt Flow	1012	34	0	457	0	58












Major/Minor	Major1	Major2	Minor1			
Conflicting Flow All	0	0	-	-	-	793
Stage 1	-	-	-	-	-	-
Stage 2	-	-	-	-	-	-
Critical Hdwy	-	-	-	-	-	6.93
Critical Hdwy Stg 1	-	-	-	-	-	-
Critical Hdwy Stg 2	-	-	-	-	-	-
Follow-up Hdwy	-	-	-	-	-	3.319
Pot Cap-1 Maneuver	-	-	0	-	0	332
Stage 1	-	-	0	-	0	-
Stage 2	-	-	0	-	0	-
Platoon blocked, %	-	-	-	-	-	-
Mov Cap-1 Maneuver	-	-	-	-	-	247
Mov Cap-2 Maneuver	-	-	-	-	-	-
Stage 1	-	-	-	-	-	-
Stage 2	-	-	-	-	-	-

Approach	EB	WB	NB
HCM Control Delay, s	0	0	24
HCM LOS			C

Minor Lane/Major Mvmt	NBLn1	EBT	EBR	WBT
Capacity (veh/h)	247	-	-	-
HCM Lane V/C Ratio	0.235	-	-	-
HCM Control Delay (s)	24	-	-	-
HCM Lane LOS	C	-	-	-
HCM 95th %tile Q(veh)	0.9	-	-	-

22: 4th Ave & Embarcadero W
 HCM 2010 Signalized Intersection Summary













03/14/2019

								
Movement	EBT	EBR	WBL	WBT	NBL	NBR		
Lane Configurations								
Traffic Volume (veh/h)	281	14	17	825	85	128		
Future Volume (veh/h)	281	14	17	825	85	128		
Number	4	14	3	8	5	12		
Initial Q (Qb), veh	0	0	0	0	0	0		
Ped-Bike Adj(A_pbT)		0.64	0.82		1.00	1.00		
Parking Bus, Adj	1.00	1.00	1.00	1.00	1.00	1.00		
Adj Sat Flow, veh/h/ln	1863	1900	1863	1863	1863	1863		
Adj Flow Rate, veh/h	305	15	18	897	92	97		
Adj No. of Lanes	1	0	1	2	1	1		
Peak Hour Factor	0.92	0.92	0.92	0.92	0.92	0.92		
Percent Heavy Veh, %	2	2	2	2	2	2		
Cap, veh/h	684	34	393	1416	710	633		
Arrive On Green	0.40	0.40	0.53	0.53	0.40	0.40		
Sat Flow, veh/h	1709	84	864	3632	1774	1583		
Grp Volume(v), veh/h	0	320	18	897	92	97		
Grp Sat Flow(s),veh/h/ln	0	1793	864	1770	1774	1583		
Q Serve(g_s), s	0.0	5.9	0.6	8.1	1.5	1.8		
Cycle Q Clear(g_c), s	0.0	5.9	6.5	8.1	1.5	1.8		
Prop In Lane		0.05	1.00		1.00	1.00		
Lane Grp Cap(c), veh/h	0	717	393	1416	710	633		
V/C Ratio(X)	0.00	0.45	0.05	0.63	0.13	0.15		
Avail Cap(c_a), veh/h	0	717	393	1416	710	633		
HCM Platoon Ratio	1.00	1.00	1.33	1.33	1.00	1.00		
Upstream Filter(I)	0.00	1.00	0.73	0.73	1.00	1.00		
Uniform Delay (d), s/veh	0.0	9.9	9.8	8.2	8.5	8.6		
Incr Delay (d2), s/veh	0.0	2.0	0.2	1.6	0.4	0.5		
Initial Q Delay(d3),s/veh	0.0	0.0	0.0	0.0	0.0	0.0		
%ile BackOfQ(50%),veh/ln	0.0	3.2	0.2	4.1	0.8	0.8		
LnGrp Delay(d),s/veh	0.0	11.9	9.9	9.8	8.9	9.1		
LnGrp LOS		B	A	A	A	A		
Approach Vol, veh/h	320			915	189			
Approach Delay, s/veh	11.9			9.8	9.0			
Approach LOS	B			A	A			
Timer	1	2	3	4	5	6	7	8
Assigned Phs		2		4				8
Phs Duration (G+Y+Rc), s		22.5		22.5				22.5
Change Period (Y+Rc), s		4.5		4.5				4.5
Max Green Setting (Gmax), s		18.0		18.0				18.0
Max Q Clear Time (g_c+I1), s		3.8		7.9				10.1
Green Ext Time (p_c), s		0.4		1.3				3.8
Intersection Summary								
HCM 2010 Ctrl Delay			10.2					
HCM 2010 LOS			B					

HCM 2010 Signalized Intersection Summary

1: Embarcadero W & Oak St

05/05/2020

								
Movement	EBL	EBR	NBL	NBT	SBT	SBR		
Lane Configurations								
Traffic Volume (veh/h)	138	344	247	635	843	31		
Future Volume (veh/h)	138	344	247	635	843	31		
Number	7	14	5	2	6	16		
Initial Q (Qb), veh	0	0	0	0	0	0		
Ped-Bike Adj(A_pbT)	1.00	1.00	1.00			0.94		
Parking Bus, Adj	1.00	1.00	1.00	1.00	1.00	1.00		
Adj Sat Flow, veh/h/ln	1676	1676	1676	1676	1676	1710		
Adj Flow Rate, veh/h	138	344	247	635	843	31		
Adj No. of Lanes	1	1	1	1	1	0		
Peak Hour Factor	1.00	1.00	1.00	1.00	1.00	1.00		
Percent Heavy Veh, %	2	2	2	2	2	2		
Cap, veh/h	423	377	205	1039	994	37		
Arrive On Green	0.26	0.26	0.62	0.62	0.62	0.62		
Sat Flow, veh/h	1597	1425	568	1676	1603	59		
Grp Volume(v), veh/h	138	344	247	635	0	874		
Grp Sat Flow(s),veh/h/ln	1597	1425	568	1676	0	1662		
Q Serve(g_s), s	5.4	18.3	15.5	18.1	0.0	33.0		
Cycle Q Clear(g_c), s	5.4	18.3	48.5	18.1	0.0	33.0		
Prop In Lane	1.00	1.00	1.00			0.04		
Lane Grp Cap(c), veh/h	423	377	205	1039	0	1030		
V/C Ratio(X)	0.33	0.91	1.21	0.61	0.00	0.85		
Avail Cap(c_a), veh/h	459	410	205	1039	0	1030		
HCM Platoon Ratio	1.00	1.00	1.00	1.00	1.00	1.00		
Upstream Filter(I)	1.00	1.00	1.00	1.00	0.00	1.00		
Uniform Delay (d), s/veh	23.1	27.9	34.8	9.1	0.0	11.9		
Incr Delay (d2), s/veh	0.4	23.2	129.4	2.7	0.0	8.7		
Initial Q Delay(d3),s/veh	0.0	0.0	0.0	0.0	0.0	0.0		
%ile BackOfQ(50%),veh/ln	2.4	9.6	11.7	9.1	0.0	17.3		
LnGrp Delay(d),s/veh	23.6	51.0	164.2	11.8	0.0	20.6		
LnGrp LOS	C	D	F	B		C		
Approach Vol, veh/h	482			882	874			
Approach Delay, s/veh	43.2			54.5	20.6			
Approach LOS	D			D	C			
Timer	1	2	3	4	5	6	7	8
Assigned Phs		2		4		6		
Phs Duration (G+Y+Rc), s		53.0		25.2		53.0		
Change Period (Y+Rc), s		4.5		4.5		4.5		
Max Green Setting (Gmax), s		48.5		22.5		48.5		
Max Q Clear Time (g_c+I1), s		50.5		20.3		35.0		
Green Ext Time (p_c), s		0.0		0.4		5.6		
Intersection Summary								
HCM 2010 Ctrl Delay			38.8					
HCM 2010 LOS			D					

2: Broadway & 5th Street
 HCM Signalized Intersection Capacity Analysis

03/14/2019



Movement	EBL	EBT	EBR	EBR2	NBT	NBR	NBR2	SBL2	SBL	SBT
Lane Configurations		↕↕	↗	↗	↕↕	↘			↘	↕↕
Traffic Volume (vph)	5	329	791	24	342	50	381	361	144	386
Future Volume (vph)	5	329	791	24	342	50	381	361	144	386
Ideal Flow (vphpl)	1900	1900	1900	1900	1900	1900	1900	1900	1900	1900
Total Lost time (s)		5.5	5.5	5.5	4.5	4.5			4.5	4.5
Lane Util. Factor		0.91	0.91	1.00	0.95	1.00			0.91	0.91
Frbp, ped/bikes		1.00	1.00	0.98	1.00	0.84			1.00	1.00
Flpb, ped/bikes		1.00	1.00	1.00	1.00	1.00			1.00	0.99
Frt		0.92	0.85	0.85	1.00	0.85			1.00	1.00
Flt Protected		1.00	1.00	1.00	1.00	1.00			0.95	0.99
Satd. Flow (prot)		2696	1248	1344	3065	1145			1395	2873
Flt Permitted		1.00	1.00	1.00	1.00	1.00			0.95	0.76
Satd. Flow (perm)		2696	1248	1344	3065	1145			1395	2208
Peak-hour factor, PHF	1.00	1.00	1.00	1.00	1.00	1.00	1.00	1.00	1.00	1.00
Adj. Flow (vph)	5	329	791	24	342	50	381	361	144	386
RTOR Reduction (vph)	0	0	0	16	0	188	0	0	0	0
Lane Group Flow (vph)	0	730	395	8	342	243	0	0	375	516
Confl. Peds. (#/hr)				5		65			65	
Confl. Bikes (#/hr)				1		6				
Heavy Vehicles (%)	6%	6%	6%	6%	6%	6%	6%	6%	6%	6%
Turn Type	Perm	NA	Prot	Perm	NA	Perm		Prot	Prot	NA
Protected Phases		4	4		2			1	1	6
Permitted Phases	4			4		2				
Actuated Green, G (s)		31.0	31.0	31.0	20.5	20.5			24.0	49.0
Effective Green, g (s)		31.0	31.0	31.0	20.5	20.5			24.0	49.0
Actuated g/C Ratio		0.34	0.34	0.34	0.23	0.23			0.27	0.54
Clearance Time (s)		5.5	5.5	5.5	4.5	4.5			4.5	4.5
Vehicle Extension (s)		2.0	2.0	2.0	2.0	2.0			2.0	2.0
Lane Grp Cap (vph)		928	429	462	698	260			372	1379
v/s Ratio Prot			c0.32		0.11				c0.27	0.10
v/s Ratio Perm		0.27		0.01		c0.21				0.10
v/c Ratio		0.88dr	0.92	0.02	0.49	0.93			1.01	0.37
Uniform Delay, d1		26.5	28.3	19.5	30.2	34.1			33.0	11.7
Progression Factor		1.00	1.00	1.00	0.98	0.94			1.00	1.00
Incremental Delay, d2		4.1	24.7	0.0	0.2	37.5			48.7	0.8
Delay (s)		30.6	53.0	19.5	29.6	69.6			81.7	12.5
Level of Service		C	D	B	C	E			F	B
Approach Delay (s)		38.1			51.9					41.6
Approach LOS		D			D					D

Intersection Summary

HCM 2000 Control Delay	43.0	HCM 2000 Level of Service	D
HCM 2000 Volume to Capacity ratio	0.95		
Actuated Cycle Length (s)	90.0	Sum of lost time (s)	14.5
Intersection Capacity Utilization	105.0%	ICU Level of Service	G
Analysis Period (min)	15		

dr Defacto Right Lane. Recode with 1 though lane as a right lane.

c Critical Lane Group

3: 6th Street & Jackson St
 HCM Signalized Intersection Capacity Analysis

03/14/2019























Movement	WBL	WBT	WBR2	NBL2	NBT	SBT	SBR	SER2
Lane Configurations	↶	↑	↷	↶	↑	↷		↷
Traffic Volume (vph)	8	517	84	253	525	189	295	999
Future Volume (vph)	8	517	84	253	525	189	295	999
Ideal Flow (vphpl)	1900	1900	1900	1900	1900	1900	1900	1900
Total Lost time (s)	5.5	5.5	5.5	5.5	5.5	5.5		5.5
Lane Util. Factor	1.00	1.00	1.00	1.00	1.00	1.00		1.00
Frpb, ped/bikes	1.00	1.00	0.99	1.00	1.00	0.98		1.00
Flpb, ped/bikes	1.00	1.00	1.00	1.00	1.00	1.00		1.00
Frt	1.00	1.00	0.85	1.00	1.00	0.92		0.86
Flt Protected	0.95	1.00	1.00	0.95	1.00	1.00		1.00
Satd. Flow (prot)	1601	1693	1420	1605	1693	1525		1450
Flt Permitted	0.95	1.00	1.00	0.38	1.00	1.00		1.00
Satd. Flow (perm)	1601	1693	1420	648	1693	1525		1450
Peak-hour factor, PHF	1.00	1.00	1.00	1.00	1.00	1.00	1.00	0.92
Adj. Flow (vph)	8	517	84	253	525	189	295	1086
RTOR Reduction (vph)	0	0	55	0	0	0	0	0
Lane Group Flow (vph)	8	517	29	253	525	484	0	1086
Confl. Peds. (#/hr)	2			5				5
Confl. Bikes (#/hr)			2					7
Heavy Vehicles (%)	1%	1%	1%	1%	1%	1%	1%	2%
Turn Type	Perm	NA	Perm	Perm	NA	NA		Perm
Protected Phases		8			2	6		
Permitted Phases	8		8	2				6 8
Actuated Green, G (s)	24.5	24.5	24.5	35.5	35.5	35.5		71.0
Effective Green, g (s)	24.5	24.5	24.5	35.5	35.5	35.5		71.0
Actuated g/C Ratio	0.35	0.35	0.35	0.50	0.50	0.50		1.00
Clearance Time (s)	5.5	5.5	5.5	5.5	5.5	5.5		
Vehicle Extension (s)	3.0	3.0	3.0	3.0	3.0	3.0		
Lane Grp Cap (vph)	552	584	490	324	846	762		1450
v/s Ratio Prot		0.31			0.31	0.32		
v/s Ratio Perm	0.00		0.02	0.39				c0.75
v/c Ratio	0.01	0.89	0.06	0.78	0.62	0.64		0.75
Uniform Delay, d1	15.3	21.9	15.5	14.6	12.9	13.0		0.0
Progression Factor	1.00	1.00	1.00	1.00	1.00	1.00		1.00
Incremental Delay, d2	0.0	14.9	0.1	16.9	3.4	4.0		2.2
Delay (s)	15.3	36.8	15.6	31.5	16.3	17.0		2.2
Level of Service	B	D	B	C	B	B		A
Approach Delay (s)		33.6			21.2	17.0		
Approach LOS		C			C	B		

Intersection Summary

HCM 2000 Control Delay	16.1	HCM 2000 Level of Service	B
HCM 2000 Volume to Capacity ratio	0.89		
Actuated Cycle Length (s)	71.0	Sum of lost time (s)	11.0
Intersection Capacity Utilization	164.4%	ICU Level of Service	H
Analysis Period (min)	15		
c Critical Lane Group			





















4: 5th Ave & Embarcadero W
 HCM 2010 Signalized Intersection Summary

03/14/2019

												
Movement	EBL	EBT	EBR	WBL	WBT	WBR	NBL	NBT	NBR	SBL	SBT	SBR
Lane Configurations												
Traffic Volume (veh/h)	47	1003	64	103	813	557	45	50	54	1279	93	75
Future Volume (veh/h)	47	1003	64	103	813	557	45	50	54	1279	93	75
Number	7	4	14	3	8	18	5	2	12	1	6	16
Initial Q (Qb), veh	0	0	0	0	0	0	0	0	0	0	0	0
Ped-Bike Adj(A_pbT)	1.00		0.96	1.00		0.97	1.00		0.95	1.00		0.97
Parking Bus, Adj	1.00	1.00	1.00	1.00	1.00	1.00	1.00	1.00	1.00	1.00	1.00	1.00
Adj Sat Flow, veh/h/ln	1863	1863	1900	1863	1863	1900	1863	1863	1900	1863	1863	1900
Adj Flow Rate, veh/h	47	1003	64	103	813	557	45	50	54	1279	93	75
Adj No. of Lanes	1	2	0	1	2	0	1	1	0	2	1	0
Peak Hour Factor	1.00	1.00	1.00	1.00	1.00	1.00	1.00	1.00	1.00	1.00	1.00	1.00
Percent Heavy Veh, %	2	2	2	2	2	2	2	2	2	2	2	2
Cap, veh/h	65	1384	88	140	822	550	175	79	85	1267	348	280
Arrive On Green	0.28	0.28	0.28	0.41	0.41	0.41	0.10	0.10	0.10	0.37	0.37	0.37
Sat Flow, veh/h	395	3370	215	527	2002	1340	1774	799	863	3442	944	761
Grp Volume(v), veh/h	47	527	540	103	716	654	45	0	104	1279	0	168
Grp Sat Flow(s),veh/h/ln	395	1770	1815	527	1770	1573	1774	0	1662	1721	0	1705
Q Serve(g_s), s	0.0	29.6	29.6	15.5	44.1	45.2	2.6	0.0	6.6	40.5	0.0	7.6
Cycle Q Clear(g_c), s	45.2	29.6	29.6	45.2	44.1	45.2	2.6	0.0	6.6	40.5	0.0	7.6
Prop In Lane	1.00		0.12	1.00		0.85	1.00		0.52	1.00		0.45
Lane Grp Cap(c), veh/h	65	727	745	140	727	646	175	0	164	1267	0	628
V/C Ratio(X)	0.72	0.72	0.72	0.74	0.99	1.01	0.26	0.00	0.64	1.01	0.00	0.27
Avail Cap(c_a), veh/h	65	727	745	140	727	646	290	0	272	1267	0	628
HCM Platoon Ratio	0.67	0.67	0.67	1.00	1.00	1.00	1.00	1.00	1.00	1.00	1.00	1.00
Upstream Filter(I)	0.43	0.43	0.43	0.67	0.67	0.67	1.00	0.00	1.00	1.00	0.00	1.00
Uniform Delay (d), s/veh	62.5	34.2	34.2	49.4	32.1	32.4	45.9	0.0	47.7	34.8	0.0	24.4
Incr Delay (d2), s/veh	25.0	2.7	2.7	20.7	24.2	32.0	0.8	0.0	4.1	27.6	0.0	0.2
Initial Q Delay(d3),s/veh	0.0	0.0	0.0	0.0	0.0	0.0	0.0	0.0	0.0	0.0	0.0	0.0
%ile BackOfQ(50%),veh/ln	1.9	15.1	15.5	3.9	26.4	25.3	1.3	0.0	3.2	24.0	0.0	3.6
LnGrp Delay(d),s/veh	87.4	37.0	36.9	70.1	56.3	64.4	46.6	0.0	51.8	62.3	0.0	24.6
LnGrp LOS	F	D	D	E	E	F	D		D	F		C
Approach Vol, veh/h		1114			1473			149			1447	
Approach Delay, s/veh		39.1			60.9			50.2			58.0	
Approach LOS		D			E			D			E	
Timer	1	2	3	4	5	6	7	8				
Assigned Phs		2		4		6		8				
Phs Duration (G+Y+Rc), s		15.3		49.7		45.0		49.7				
Change Period (Y+Rc), s		4.5		4.5		4.5		4.5				
Max Green Setting (Gmax), s		18.0		38.0		40.5		38.0				
Max Q Clear Time (g_c+I1), s		8.6		47.2		42.5		47.2				
Green Ext Time (p_c), s		0.4		0.0		0.0		0.0				
Intersection Summary												
HCM 2010 Ctrl Delay				53.7								
HCM 2010 LOS				D								























5: 6th Ave/880 Off-Ramp & Embarcadero W
 HCM 2010 Signalized Intersection Summary

03/14/2019

												
Movement	EBL	EBT	EBR	WBL	WBT	WBR	NBL	NBT	NBR	SBL	SBT	SBR
Lane Configurations												
Traffic Volume (veh/h)	0	1940	317	66	783	0	212	0	101	258	123	493
Future Volume (veh/h)	0	1940	317	66	783	0	212	0	101	258	123	493
Number	7	4	14	3	8	18	5	2	12	1	6	16
Initial Q (Qb), veh	0	0	0	0	0	0	0	0	0	0	0	0
Ped-Bike Adj(A_pbT)	1.00		0.81	1.00		1.00	1.00		1.00	1.00		1.00
Parking Bus, Adj	1.00	1.00	1.00	1.00	1.00	1.00	1.00	1.00	1.00	1.00	1.00	1.00
Adj Sat Flow, veh/h/ln	0	1863	1900	1863	1863	0	1863	0	1863	1863	1863	1863
Adj Flow Rate, veh/h	0	1940	317	66	783	0	212	0	15	258	123	393
Adj No. of Lanes	0	2	0	1	2	0	1	0	1	1	1	1
Peak Hour Factor	1.00	1.00	1.00	1.00	1.00	1.00	1.00	1.00	1.00	1.00	1.00	1.00
Percent Heavy Veh, %	0	2	2	2	2	0	2	0	2	2	2	2
Cap, veh/h	0	1958	299	65	2333	0	0	0	0	460	483	410
Arrive On Green	0.00	0.44	0.44	0.88	0.88	0.00	0.00	0.00	0.00	0.26	0.26	0.26
Sat Flow, veh/h	0	3064	453	166	3632	0		0		1774	1863	1583
Grp Volume(v), veh/h	0	1100	1157	66	783	0		0.0		258	123	393
Grp Sat Flow(s),veh/h/ln	0	1770	1654	166	1770	0				1774	1863	1583
Q Serve(g_s), s	0.0	65.4	72.5	0.0	4.3	0.0				13.9	5.8	26.9
Cycle Q Clear(g_c), s	0.0	65.4	72.5	72.5	4.3	0.0				13.9	5.8	26.9
Prop In Lane	0.00		0.27	1.00		0.00				1.00		1.00
Lane Grp Cap(c), veh/h	0	1166	1090	65	2333	0				460	483	410
V/C Ratio(X)	0.00	0.94	1.06	1.01	0.34	0.00				0.56	0.25	0.96
Avail Cap(c_a), veh/h	0	1166	1090	65	2333	0				460	483	410
HCM Platoon Ratio	1.00	0.67	0.67	1.33	1.33	1.00				1.00	1.00	1.00
Upstream Filter(I)	0.00	0.37	0.37	0.88	0.88	0.00				1.00	1.00	1.00
Uniform Delay (d), s/veh	0.0	28.7	30.7	43.0	2.6	0.0				35.3	32.3	40.2
Incr Delay (d2), s/veh	0.0	7.3	35.9	107.0	0.3	0.0				1.6	0.3	33.6
Initial Q Delay(d3),s/veh	0.0	0.0	0.0	0.0	0.0	0.0				0.0	0.0	0.0
%ile BackOfQ(50%),veh/ln	0.0	34.3	44.0	3.9	2.1	0.0				7.0	3.0	15.6
LnGrp Delay(d),s/veh	0.0	36.0	66.6	150.0	2.9	0.0				36.9	32.6	73.8
LnGrp LOS		D	F	F	A					D	C	E
Approach Vol, veh/h		2257			849						774	
Approach Delay, s/veh		51.7			14.4						54.9	
Approach LOS		D			B						D	
Timer	1	2	3	4	5	6	7	8				
Assigned Phs				4		6		8				
Phs Duration (G+Y+Rc), s				77.0		33.0		77.0				
Change Period (Y+Rc), s				4.5		4.5		4.5				
Max Green Setting (Gmax), s				50.0		28.5		50.0				
Max Q Clear Time (g_c+I1), s				74.5		28.9		74.5				
Green Ext Time (p_c), s				0.0		0.0		0.0				
Intersection Summary												
HCM 2010 Ctrl Delay			44.2									
HCM 2010 LOS			D									

















6: Webster St & Atlantic Ave
 HCM 2010 Signalized Intersection Summary

03/14/2019

												
Movement	EBL	EBT	EBR	WBL	WBT	WBR	NBL	NBT	NBR	SBL	SBT	SBR
Lane Configurations												
Traffic Volume (veh/h)	182	336	152	60	259	106	110	450	57	174	798	301
Future Volume (veh/h)	182	336	152	60	259	106	110	450	57	174	798	301
Number	7	4	14	3	8	18	5	2	12	1	6	16
Initial Q (Qb), veh	0	0	0	0	0	0	0	0	0	0	0	0
Ped-Bike Adj(A_pbT)	1.00		0.93	1.00		0.93	1.00		0.95	1.00		0.95
Parking Bus, Adj	1.00	1.00	1.00	1.00	1.00	1.00	1.00	1.00	1.00	1.00	1.00	1.00
Adj Sat Flow, veh/h/ln	1863	1863	1863	1863	1863	1900	1863	1863	1900	1863	1863	1863
Adj Flow Rate, veh/h	184	339	32	61	262	107	111	455	58	176	806	110
Adj No. of Lanes	2	2	1	1	2	0	2	2	0	1	2	1
Peak Hour Factor	0.99	0.99	0.99	0.99	0.99	0.99	0.99	0.99	0.99	0.99	0.99	0.99
Percent Heavy Veh, %	2	2	2	2	2	2	2	2	2	2	2	2
Cap, veh/h	681	701	292	367	502	198	181	809	103	219	1163	494
Arrive On Green	0.20	0.20	0.20	0.21	0.21	0.21	0.05	0.26	0.26	0.12	0.33	0.33
Sat Flow, veh/h	3442	3539	1474	1774	2429	955	3442	3139	398	1774	3539	1504
Grp Volume(v), veh/h	184	339	32	61	188	181	111	255	258	176	806	110
Grp Sat Flow(s),veh/h/ln	1721	1770	1474	1774	1770	1615	1721	1770	1767	1774	1770	1504
Q Serve(g_s), s	3.6	6.7	1.4	2.2	7.5	7.9	2.5	9.9	10.1	7.7	15.7	4.2
Cycle Q Clear(g_c), s	3.6	6.7	1.4	2.2	7.5	7.9	2.5	9.9	10.1	7.7	15.7	4.2
Prop In Lane	1.00		1.00	1.00		0.59	1.00		0.22	1.00		1.00
Lane Grp Cap(c), veh/h	681	701	292	367	366	334	181	456	456	219	1163	494
V/C Ratio(X)	0.27	0.48	0.11	0.17	0.51	0.54	0.61	0.56	0.57	0.80	0.69	0.22
Avail Cap(c_a), veh/h	1083	1114	464	558	557	508	303	579	578	447	1738	738
HCM Platoon Ratio	1.00	1.00	1.00	1.00	1.00	1.00	1.00	1.00	1.00	1.00	1.00	1.00
Upstream Filter(I)	1.00	1.00	1.00	1.00	1.00	1.00	1.00	1.00	1.00	1.00	1.00	1.00
Uniform Delay (d), s/veh	27.0	28.3	26.1	25.9	28.0	28.1	36.8	25.6	25.6	33.9	23.2	19.3
Incr Delay (d2), s/veh	0.2	0.5	0.2	0.2	1.1	1.4	3.3	1.1	1.1	6.8	0.8	0.2
Initial Q Delay(d3),s/veh	0.0	0.0	0.0	0.0	0.0	0.0	0.0	0.0	0.0	0.0	0.0	0.0
%ile BackOfQ(50%),veh/ln	1.7	3.3	0.6	1.1	3.8	3.6	1.3	5.0	5.0	4.2	7.7	1.8
LnGrp Delay(d),s/veh	27.2	28.8	26.3	26.1	29.1	29.5	40.2	26.6	26.7	40.7	23.9	19.5
LnGrp LOS	C	C	C	C	C	C	D	C	C	D	C	B
Approach Vol, veh/h		555			430			624			1092	
Approach Delay, s/veh		28.1			28.8			29.1			26.2	
Approach LOS		C			C			C			C	
Timer	1	2	3	4	5	6	7	8				
Assigned Phs	1	2		4	5	6		8				
Phs Duration (G+Y+Rc), s	13.8	25.5		19.7	8.2	31.1		20.4				
Change Period (Y+Rc), s	4.0	5.0		4.0	4.0	5.0		4.0				
Max Green Setting (Gmax), s	20.0	26.0		25.0	7.0	39.0		25.0				
Max Q Clear Time (g_c+1), s	9.7	12.1		8.7	4.5	17.7		9.9				
Green Ext Time (p_c), s	0.3	2.8		2.8	0.1	6.5		2.2				
Intersection Summary												
HCM 2010 Ctrl Delay				27.7								
HCM 2010 LOS				C								

















7: Broadway & Embarcadero W
 HCM 2010 Signalized Intersection Summary

03/14/2019

												
Movement	EBL	EBT	EBR	WBL	WBT	WBR	NBL	NBT	NBR	SBL	SBT	SBR
Lane Configurations												
Traffic Volume (veh/h)	24	158	45	101	40	203	13	62	143	228	78	34
Future Volume (veh/h)	24	158	45	101	40	203	13	62	143	228	78	34
Number	7	4	14	3	8	18	5	2	12	1	6	16
Initial Q (Qb), veh	0	0	0	0	0	0	0	0	0	0	0	0
Ped-Bike Adj(A_pbT)	0.98		0.96	0.98		0.96	0.90		0.85	0.92		0.85
Parking Bus, Adj	1.00	1.00	1.00	1.00	1.00	1.00	1.00	1.00	1.00	1.00	1.00	1.00
Adj Sat Flow, veh/h/ln	1710	1660	1710	1710	1660	1710	1710	1660	1710	1710	1660	1710
Adj Flow Rate, veh/h	24	158	45	101	40	203	13	62	143	228	78	34
Adj No. of Lanes	0	1	0	0	1	0	0	1	0	0	2	0
Peak Hour Factor	1.00	1.00	1.00	1.00	1.00	1.00	1.00	1.00	1.00	1.00	1.00	1.00
Percent Heavy Veh, %	3	3	3	3	3	3	3	3	3	3	3	3
Cap, veh/h	116	467	122	214	105	310	96	170	346	555	377	164
Arrive On Green	0.40	0.40	0.40	0.40	0.40	0.40	0.40	0.40	0.40	0.40	0.40	0.40
Sat Flow, veh/h	70	1168	306	275	262	774	27	426	864	987	943	411
Grp Volume(v), veh/h	227	0	0	344	0	0	218	0	0	228	0	112
Grp Sat Flow(s),veh/h/ln	1543	0	0	1312	0	0	1317	0	0	987	0	1354
Q Serve(g_s), s	0.0	0.0	0.0	4.5	0.0	0.0	0.0	0.0	0.0	2.5	0.0	2.4
Cycle Q Clear(g_c), s	4.5	0.0	0.0	9.1	0.0	0.0	5.3	0.0	0.0	7.7	0.0	2.4
Prop In Lane	0.11		0.20	0.29		0.59	0.06		0.66	1.00		0.30
Lane Grp Cap(c), veh/h	706	0	0	628	0	0	612	0	0	555	0	541
V/C Ratio(X)	0.32	0.00	0.00	0.55	0.00	0.00	0.36	0.00	0.00	0.41	0.00	0.21
Avail Cap(c_a), veh/h	706	0	0	628	0	0	612	0	0	555	0	541
HCM Platoon Ratio	1.00	1.00	1.00	1.00	1.00	1.00	1.00	1.00	1.00	1.00	1.00	1.00
Upstream Filter(I)	1.00	0.00	0.00	1.00	0.00	0.00	1.00	0.00	0.00	1.00	0.00	1.00
Uniform Delay (d), s/veh	9.5	0.0	0.0	10.7	0.0	0.0	9.7	0.0	0.0	10.4	0.0	8.8
Incr Delay (d2), s/veh	1.2	0.0	0.0	3.4	0.0	0.0	1.6	0.0	0.0	2.2	0.0	0.9
Initial Q Delay(d3),s/veh	0.0	0.0	0.0	0.0	0.0	0.0	0.0	0.0	0.0	0.0	0.0	0.0
%ile BackOfQ(50%),veh/ln	2.2	0.0	0.0	3.9	0.0	0.0	2.2	0.0	0.0	2.5	0.0	1.0
LnGrp Delay(d),s/veh	10.7	0.0	0.0	14.1	0.0	0.0	11.3	0.0	0.0	12.6	0.0	9.7
LnGrp LOS	B			B			B			B		A
Approach Vol, veh/h		227			344			218				340
Approach Delay, s/veh		10.7			14.1			11.3				11.7
Approach LOS		B			B			B				B
Timer	1	2	3	4	5	6	7	8				
Assigned Phs		2		4		6		8				
Phs Duration (G+Y+Rc), s		22.5		22.5		22.5		22.5				
Change Period (Y+Rc), s		4.5		4.5		4.5		4.5				
Max Green Setting (Gmax), s		18.0		18.0		18.0		18.0				
Max Q Clear Time (g_c+I1), s		7.3		6.5		9.7		11.1				
Green Ext Time (p_c), s		1.0		1.0		1.4		1.3				
Intersection Summary												
HCM 2010 Ctrl Delay				12.1								
HCM 2010 LOS				B								






















8: Oak St & 5th Street
 HCM 2010 Signalized Intersection Summary

03/14/2019

												
Movement	EBL	EBT	EBR	WBL	WBT	WBR	NBL	NBT	NBR	SBL	SBT	SBR
Lane Configurations												
Traffic Volume (veh/h)	421	801	392	0	0	0	0	471	194	3	19	0
Future Volume (veh/h)	421	801	392	0	0	0	0	471	194	3	19	0
Number	7	4	14				5	2	12	1	6	16
Initial Q (Qb), veh	0	0	0				0	0	0	0	0	0
Ped-Bike Adj(A_pbT)	1.00		0.98				1.00		0.95	1.00		1.00
Parking Bus, Adj	1.00	1.00	1.00				1.00	1.00	1.00	1.00	1.00	1.00
Adj Sat Flow, veh/h/ln	1660	1660	1710				0	1660	1710	1710	1660	0
Adj Flow Rate, veh/h	421	801	392				0	471	194	3	19	0
Adj No. of Lanes	1	2	0				0	1	0	0	1	0
Peak Hour Factor	1.00	1.00	1.00				1.00	1.00	1.00	1.00	1.00	1.00
Percent Heavy Veh, %	3	3	3				0	3	3	3	3	0
Cap, veh/h	740	955	465				0	495	204	44	232	0
Arrive On Green	0.47	0.47	0.47				0.00	0.45	0.45	0.45	0.45	0.00
Sat Flow, veh/h	1581	2040	994				0	1100	453	16	515	0
Grp Volume(v), veh/h	421	618	575				0	0	665	22	0	0
Grp Sat Flow(s),veh/h/ln	1581	1577	1457				0	0	1553	531	0	0
Q Serve(g_s), s	21.2	37.7	38.1				0.0	0.0	45.3	0.5	0.0	0.0
Cycle Q Clear(g_c), s	21.2	37.7	38.1				0.0	0.0	45.3	45.8	0.0	0.0
Prop In Lane	1.00		0.68				0.00		0.29	0.14		0.00
Lane Grp Cap(c), veh/h	740	738	682				0	0	699	276	0	0
V/C Ratio(X)	0.57	0.84	0.84				0.00	0.00	0.95	0.08	0.00	0.00
Avail Cap(c_a), veh/h	740	738	682				0	0	699	276	0	0
HCM Platoon Ratio	1.00	1.00	1.00				1.00	1.00	1.00	1.00	1.00	1.00
Upstream Filter(I)	1.00	1.00	1.00				0.00	0.00	1.00	1.00	0.00	0.00
Uniform Delay (d), s/veh	21.2	25.6	25.7				0.0	0.0	29.1	21.9	0.0	0.0
Incr Delay (d2), s/veh	3.2	10.9	12.1				0.0	0.0	24.1	0.6	0.0	0.0
Initial Q Delay(d3),s/veh	0.0	0.0	0.0				0.0	0.0	0.0	0.0	0.0	0.0
%ile BackOfQ(50%),veh/ln	9.9	18.6	17.5				0.0	0.0	24.1	0.4	0.0	0.0
LnGrp Delay(d),s/veh	24.4	36.5	37.8				0.0	0.0	53.2	22.4	0.0	0.0
LnGrp LOS	C	D	D						D	C		
Approach Vol, veh/h		1614						665			22	
Approach Delay, s/veh		33.8						53.2			22.4	
Approach LOS		C						D			C	
Timer	1	2	3	4	5	6	7	8				
Assigned Phs		2		4		6						
Phs Duration (G+Y+Rc), s		54.0		56.0		54.0						
Change Period (Y+Rc), s		4.5		4.5		4.5						
Max Green Setting (Gmax), s		49.5		51.5		49.5						
Max Q Clear Time (g_c+I1), s		47.3		40.1		47.8						
Green Ext Time (p_c), s		0.8		5.1		0.0						
Intersection Summary												
HCM 2010 Ctrl Delay			39.3									
HCM 2010 LOS			D									













9: Harrison St & Grand Ave
 HCM 2010 Signalized Intersection Summary

03/14/2019

												
Movement	EBL	EBT	EBR	WBL	WBT	WBR	NBL	NBT	NBR	SBL	SBT	SBR
Lane Configurations												
Traffic Volume (veh/h)	162	790	79	173	294	25	0	892	609	0	407	108
Future Volume (veh/h)	162	790	79	173	294	25	0	892	609	0	407	108
Number	3	8	18	7	4	14	5	2	12	1	6	16
Initial Q (Qb), veh	0	0	0	0	0	0	0	0	0	0	0	0
Ped-Bike Adj(A_pbT)	1.00		0.72	1.00		0.89	1.00		1.00	1.00		0.82
Parking Bus, Adj	1.00	1.00	1.00	1.00	1.00	1.00	1.00	1.00	1.00	1.00	1.00	1.00
Adj Sat Flow, veh/h/ln	1881	1881	1881	1881	1881	1900	0	1881	1881	0	1881	1881
Adj Flow Rate, veh/h	162	790	25	173	294	25	0	892	0	0	407	51
Adj No. of Lanes	2	2	1	2	2	0	0	3	1	0	2	1
Peak Hour Factor	1.00	1.00	1.00	1.00	1.00	1.00	1.00	1.00	1.00	1.00	1.00	1.00
Percent Heavy Veh, %	1	1	1	1	1	1	0	1	1	0	1	1
Cap, veh/h	225	1085	347	1006	1792	151	0	1305	406	0	908	332
Arrive On Green	0.06	0.30	0.30	0.29	0.54	0.54	0.00	0.25	0.00	0.00	0.25	0.25
Sat Flow, veh/h	3476	3574	1144	3476	3300	277	0	5305	1599	0	3668	1308
Grp Volume(v), veh/h	162	790	25	173	158	161	0	892	0	0	407	51
Grp Sat Flow(s),veh/h/ln	1738	1787	1144	1738	1787	1790	0	1712	1599	0	1787	1308
Q Serve(g_s), s	5.0	21.7	1.7	4.1	4.9	5.0	0.0	17.2	0.0	0.0	10.5	3.3
Cycle Q Clear(g_c), s	5.0	21.7	1.7	4.1	4.9	5.0	0.0	17.2	0.0	0.0	10.5	3.3
Prop In Lane	1.00		1.00	1.00		0.15	0.00		1.00	0.00		1.00
Lane Grp Cap(c), veh/h	225	1085	347	1006	971	972	0	1305	406	0	908	332
V/C Ratio(X)	0.72	0.73	0.07	0.17	0.16	0.17	0.00	0.68	0.00	0.00	0.45	0.15
Avail Cap(c_a), veh/h	316	1085	347	1006	971	972	0	2540	791	0	1768	647
HCM Platoon Ratio	1.00	1.00	1.00	1.00	1.00	1.00	1.00	1.00	1.00	1.00	1.00	1.00
Upstream Filter(I)	1.00	1.00	1.00	1.00	1.00	1.00	0.00	1.00	0.00	0.00	1.00	1.00
Uniform Delay (d), s/veh	50.5	34.2	27.3	29.2	12.6	12.6	0.0	37.0	0.0	0.0	34.5	31.8
Incr Delay (d2), s/veh	4.7	4.3	0.4	0.1	0.4	0.4	0.0	0.6	0.0	0.0	0.3	0.2
Initial Q Delay(d3),s/veh	0.0	0.0	0.0	0.0	0.0	0.0	0.0	0.0	0.0	0.0	0.0	0.0
%ile BackOfQ(50%),veh/ln	2.6	11.4	0.6	2.0	2.5	2.6	0.0	8.3	0.0	0.0	5.2	1.2
LnGrp Delay(d),s/veh	55.2	38.5	27.7	29.3	13.0	13.0	0.0	37.7	0.0	0.0	34.9	32.1
LnGrp LOS	E	D	C	C	B	B		D			C	C
Approach Vol, veh/h		977			492			892			458	
Approach Delay, s/veh		41.0			18.7			37.7			34.6	
Approach LOS		D			B			D			C	
Timer	1	2	3	4	5	6	7	8				
Assigned Phs		2	3	4		6	7	8				
Phs Duration (G+Y+Rc), s		33.6	11.1	65.3		33.6	37.4	39.0				
Change Period (Y+Rc), s		5.6	4.0	5.6		5.6	5.6	* 5.6				
Max Green Setting (Gmax), s		54.4	10.0	30.4		54.4	7.0	* 33				
Max Q Clear Time (g_c+I1), s		19.2	7.0	7.0		12.5	6.1	23.7				
Green Ext Time (p_c), s		7.5	0.1	1.8		3.2	0.0	3.9				
Intersection Summary												
HCM 2010 Ctrl Delay			35.0									
HCM 2010 LOS			D									
Notes												



















10: Lakeshore Ave & Foothill Blvd
 HCM 2010 Signalized Intersection Summary

03/14/2019

								
Movement	WBL	WBR	NBT	NBR	SBL	SBT		
Lane Configurations	 		 			 		
Traffic Volume (veh/h)	111	111	1190	0	0	730		
Future Volume (veh/h)	111	111	1190	0	0	730		
Number	3	18	2	12	1	6		
Initial Q (Qb), veh	0	0	0	0	0	0		
Ped-Bike Adj(A_pbT)	1.00	1.00		1.00	1.00			
Parking Bus, Adj	1.00	1.00	1.00	1.00	1.00	1.00		
Adj Sat Flow, veh/h/ln	1863	1900	1863	0	0	1863		
Adj Flow Rate, veh/h	111	111	1190	0	0	730		
Adj No. of Lanes	1	1	2	0	0	2		
Peak Hour Factor	1.00	1.00	1.00	1.00	1.00	1.00		
Percent Heavy Veh, %	2	0	2	0	0	2		
Cap, veh/h	157	142	3002	0	0	3002		
Arrive On Green	0.09	0.09	0.85	0.00	0.00	0.85		
Sat Flow, veh/h	1774	1615	3725	0	0	3725		
Grp Volume(v), veh/h	111	111	1190	0	0	730		
Grp Sat Flow(s),veh/h/ln	1774	1615	1770	0	0	1770		
Q Serve(g_s), s	6.7	7.4	8.5	0.0	0.0	4.3		
Cycle Q Clear(g_c), s	6.7	7.4	8.5	0.0	0.0	4.3		
Prop In Lane	1.00	1.00		0.00	0.00			
Lane Grp Cap(c), veh/h	157	142	3002	0	0	3002		
V/C Ratio(X)	0.71	0.78	0.40	0.00	0.00	0.24		
Avail Cap(c_a), veh/h	476	433	3002	0	0	3002		
HCM Platoon Ratio	1.00	1.00	1.00	1.00	1.00	1.00		
Upstream Filter(I)	1.00	1.00	1.00	0.00	0.00	1.00		
Uniform Delay (d), s/veh	48.8	49.1	1.9	0.0	0.0	1.6		
Incr Delay (d2), s/veh	2.2	3.5	0.4	0.0	0.0	0.2		
Initial Q Delay(d3),s/veh	0.0	0.0	0.0	0.0	0.0	0.0		
%ile BackOfQ(50%),veh/ln	3.4	3.4	4.1	0.0	0.0	2.1		
LnGrp Delay(d),s/veh	51.0	52.6	2.3	0.0	0.0	1.8		
LnGrp LOS	D	D	A			A		
Approach Vol, veh/h	222		1190			730		
Approach Delay, s/veh	51.8		2.3			1.8		
Approach LOS	D		A			A		
Timer	1	2	3	4	5	6	7	8
Assigned Phs		2				6		8
Phs Duration (G+Y+Rc), s		96.8				96.8		13.2
Change Period (Y+Rc), s		3.5				3.5		3.5
Max Green Setting (Gmax), s		73.5				73.5		29.5
Max Q Clear Time (g_c+I1), s		10.5				6.3		9.4
Green Ext Time (p_c), s		8.1				4.1		0.3
Intersection Summary								
HCM 2010 Ctrl Delay			7.3					
HCM 2010 LOS			A					
Notes								




















11: Lakeshore Ave & MacArthur Blvd
 HCM 2010 Signalized Intersection Summary

03/14/2019

												
Movement	EBL	EBT	EBR	WBL	WBT	WBR	NBL	NBT	NBR	SBL	SBT	SBR
Lane Configurations												
Traffic Volume (veh/h)	209	1237	111	0	0	0	0	447	424	296	444	0
Future Volume (veh/h)	209	1237	111	0	0	0	0	447	424	296	444	0
Number	7	4	14				5	2	12	1	6	16
Initial Q (Qb), veh	0	0	0				0	0	0	0	0	0
Ped-Bike Adj(A_pbT)	1.00		0.94				1.00		0.92	1.00		1.00
Parking Bus, Adj	1.00	1.00	1.00				1.00	1.00	1.00	1.00	1.00	1.00
Adj Sat Flow, veh/h/ln	1881	1881	1881				0	1881	1900	1881	1881	0
Adj Flow Rate, veh/h	209	1237	77				0	447	424	296	444	0
Adj No. of Lanes	1	3	1				0	2	0	1	2	0
Peak Hour Factor	1.00	1.00	1.00				1.00	1.00	1.00	1.00	1.00	1.00
Percent Heavy Veh, %	1	1	1				0	1	1	1	1	0
Cap, veh/h	501	1578	422				0	590	488	479	2271	0
Arrive On Green	0.28	0.28	0.28				0.00	0.33	0.33	0.54	1.00	0.00
Sat Flow, veh/h	1792	5644	1510				0	1881	1478	1792	3668	0
Grp Volume(v), veh/h	209	1237	77				0	447	424	296	444	0
Grp Sat Flow(s),veh/h/ln	1792	1881	1510				0	1787	1478	1792	1787	0
Q Serve(g_s), s	10.1	21.4	4.1				0.0	23.7	28.6	12.2	0.0	0.0
Cycle Q Clear(g_c), s	10.1	21.4	4.1				0.0	23.7	28.6	12.2	0.0	0.0
Prop In Lane	1.00		1.00				0.00		1.00	1.00		0.00
Lane Grp Cap(c), veh/h	501	1578	422				0	590	488	479	2271	0
V/C Ratio(X)	0.42	0.78	0.18				0.00	0.76	0.87	0.62	0.20	0.00
Avail Cap(c_a), veh/h	659	2076	556				0	590	488	479	2271	0
HCM Platoon Ratio	1.00	1.00	1.00				1.00	1.00	1.00	2.00	2.00	1.00
Upstream Filter(I)	1.00	1.00	1.00				0.00	1.00	1.00	0.82	0.82	0.00
Uniform Delay (d), s/veh	31.1	35.2	29.0				0.0	31.7	33.3	20.9	0.0	0.0
Incr Delay (d2), s/veh	0.2	1.0	0.1				0.0	8.8	18.5	1.5	0.2	0.0
Initial Q Delay(d3),s/veh	0.0	0.0	0.0				0.0	0.0	0.0	0.0	0.0	0.0
%ile BackOfQ(50%),veh/ln	5.0	11.3	1.7				0.0	13.1	14.2	6.1	0.0	0.0
LnGrp Delay(d),s/veh	31.3	36.3	29.1				0.0	40.5	51.9	22.3	0.2	0.0
LnGrp LOS	C	D	C					D	D	C	A	
Approach Vol, veh/h		1523						871			740	
Approach Delay, s/veh		35.2						46.1			9.0	
Approach LOS		D						D			A	
Timer	1	2	3	4	5	6	7	8				
Assigned Phs	1	2		4		6						
Phs Duration (G+Y+Rc), s	32.4	39.0		34.6		71.4						
Change Period (Y+Rc), s	4.0	* 4		5.0		4.0						
Max Green Setting (Gmax), s	19.5	* 35		39.0		58.0						
Max Q Clear Time (g_c+I1), s	14.2	30.6		23.4		2.0						
Green Ext Time (p_c), s	0.2	1.8		6.2		2.3						
Intersection Summary												
HCM 2010 Ctrl Delay			32.1									
HCM 2010 LOS			C									
Notes												

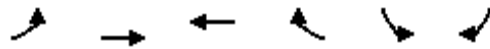
12: Lakeshore Ave & Lake Park Ave
 HCM 2010 Signalized Intersection Summary

03/14/2019

												
Movement	EBL	EBT	EBR	WBL	WBT	WBR	NBL	NBT	NBR	SBL	SBT	SBR
Lane Configurations												
Traffic Volume (veh/h)	140	0	132	301	399	266	219	418	0	0	318	160
Future Volume (veh/h)	140	0	132	301	399	266	219	418	0	0	318	160
Number	7	4	14	3	8	18	5	2	12	1	6	16
Initial Q (Qb), veh	0	0	0	0	0	0	0	0	0	0	0	0
Ped-Bike Adj(A_pbT)	1.00		0.99	1.00		1.00	1.00		1.00	1.00		0.83
Parking Bus, Adj	1.00	1.00	1.00	1.00	1.00	1.00	1.00	1.00	1.00	1.00	1.00	1.00
Adj Sat Flow, veh/h/ln	1881	1881	1900	1900	1881	1881	1881	1881	0	0	1881	1900
Adj Flow Rate, veh/h	136	6	132	301	399	0	219	418	0	0	318	160
Adj No. of Lanes	1	1	0	0	2	1	2	1	0	0	2	0
Peak Hour Factor	1.00	1.00	1.00	1.00	1.00	1.00	1.00	1.00	1.00	1.00	1.00	1.00
Percent Heavy Veh, %	1	1	1	1	1	1	1	1	0	0	1	1
Cap, veh/h	190	7	161	592	590	528	450	794	0	0	547	262
Arrive On Green	0.11	0.11	0.11	0.33	0.33	0.00	0.26	0.84	0.00	0.00	0.25	0.25
Sat Flow, veh/h	1792	69	1519	1792	1787	1599	3476	1881	0	0	2281	1046
Grp Volume(v), veh/h	136	0	138	301	399	0	219	418	0	0	257	221
Grp Sat Flow(s),veh/h/ln	1792	0	1588	1792	1787	1599	1738	1881	0	0	1787	1446
Q Serve(g_s), s	7.8	0.0	9.0	14.3	20.4	0.0	5.7	6.6	0.0	0.0	13.3	14.4
Cycle Q Clear(g_c), s	7.8	0.0	9.0	14.3	20.4	0.0	5.7	6.6	0.0	0.0	13.3	14.4
Prop In Lane	1.00		0.96	1.00		1.00	1.00		0.00	0.00		0.72
Lane Grp Cap(c), veh/h	190	0	169	592	590	528	450	794	0	0	447	361
V/C Ratio(X)	0.71	0.00	0.82	0.51	0.68	0.00	0.49	0.53	0.00	0.00	0.58	0.61
Avail Cap(c_a), veh/h	245	0	217	592	590	528	450	794	0	0	447	361
HCM Platoon Ratio	1.00	1.00	1.00	1.00	1.00	1.00	2.00	2.00	1.00	1.00	1.00	1.00
Upstream Filter(I)	1.00	0.00	1.00	1.00	1.00	0.00	0.68	0.68	0.00	0.00	1.00	1.00
Uniform Delay (d), s/veh	45.8	0.0	46.4	28.6	30.6	0.0	36.3	5.3	0.0	0.0	34.8	35.2
Incr Delay (d2), s/veh	4.1	0.0	13.5	3.1	6.1	0.0	0.2	1.7	0.0	0.0	5.3	7.5
Initial Q Delay(d3),s/veh	0.0	0.0	0.0	0.0	0.0	0.0	0.0	0.0	0.0	0.0	0.0	0.0
%ile BackOfQ(50%),veh/ln	4.1	0.0	4.6	7.6	11.1	0.0	2.7	3.6	0.0	0.0	7.2	6.5
LnGrp Delay(d),s/veh	49.9	0.0	59.9	31.7	36.7	0.0	36.5	7.0	0.0	0.0	40.1	42.7
LnGrp LOS	D		E	C	D		D	A			D	D
Approach Vol, veh/h		274			700			637			478	
Approach Delay, s/veh		54.9			34.6			17.1			41.3	
Approach LOS		D			C			B			D	
Timer	1	2	3	4	5	6	7	8				
Assigned Phs		2		4	5	6		8				
Phs Duration (G+Y+Rc), s		49.2		16.8	18.2	31.0		40.0				
Change Period (Y+Rc), s		4.5		5.5	4.5	* 4.5		5.0				
Max Green Setting (Gmax), s		41.5		14.5	11.0	* 27		35.0				
Max Q Clear Time (g_c+I1), s		8.6		11.0	7.7	16.4		22.4				
Green Ext Time (p_c), s		1.9		0.3	0.1	1.6		2.4				
Intersection Summary												
HCM 2010 Ctrl Delay			33.5									
HCM 2010 LOS			C									
Notes												

13: Embarcadero W & 880 On-Ramp
 HCM 2010 Signalized Intersection Summary
























03/14/2019



Movement	EBL	EBT	WBT	WBR	SBL	SBR		
Lane Configurations								
Traffic Volume (veh/h)	1017	845	548	102	0	0		
Future Volume (veh/h)	1017	845	548	102	0	0		
Number	7	4	8	18				
Initial Q (Qb), veh	0	0	0	0				
Ped-Bike Adj(A_pbT)	1.00			1.00				
Parking Bus, Adj	1.00	1.00	1.00	1.00				
Adj Sat Flow, veh/h/ln	1863	1863	1863	1900				
Adj Flow Rate, veh/h	1017	845	548	0				
Adj No. of Lanes	1	2	1	0				
Peak Hour Factor	1.00	1.00	1.00	1.00				
Percent Heavy Veh, %	2	2	2	2				
Cap, veh/h	998	3394	662	0				
Arrive On Green	0.94	1.00	0.36	0.00				
Sat Flow, veh/h	1774	3632	1863	0				
Grp Volume(v), veh/h	1017	845	548	0				
Grp Sat Flow(s),veh/h/ln	1774	1770	1863	0				
Q Serve(g_s), s	61.9	0.0	29.6	0.0				
Cycle Q Clear(g_c), s	61.9	0.0	29.6	0.0				
Prop In Lane	1.00			0.00				
Lane Grp Cap(c), veh/h	998	3394	662	0				
V/C Ratio(X)	1.02	0.25	0.83	0.00				
Avail Cap(c_a), veh/h	998	3394	662	0				
HCM Platoon Ratio	1.67	1.67	1.00	1.00				
Upstream Filter(I)	1.00	1.00	1.00	0.00				
Uniform Delay (d), s/veh	3.3	0.0	32.4	0.0				
Incr Delay (d2), s/veh	33.3	0.2	11.4	0.0				
Initial Q Delay(d3),s/veh	0.0	0.0	0.0	0.0				
%ile BackOfQ(50%),veh/ln	32.3	0.1	17.3	0.0				
LnGrp Delay(d),s/veh	36.6	0.2	43.8	0.0				
LnGrp LOS	F	A	D					
Approach Vol, veh/h		1862	548					
Approach Delay, s/veh		20.1	43.8					
Approach LOS		C	D					
Timer	1	2	3	4	5	6	7	8
Assigned Phs				4			7	8
Phs Duration (G+Y+Rc), s				110.0			66.4	43.6
Change Period (Y+Rc), s				4.5			4.5	4.5
Max Green Setting (Gmax), s				105.5			61.9	39.1
Max Q Clear Time (g_c+I1), s				2.0			63.9	31.6
Green Ext Time (p_c), s				7.5			0.0	2.1
Intersection Summary								
HCM 2010 Ctrl Delay			25.4					
HCM 2010 LOS			C					



















14: 5th Ave & E 8th St
 HCM 2010 Signalized Intersection Summary

03/14/2019

												
Movement	EBL	EBT	EBR	WBL	WBT	WBR	NBL	NBT	NBR	SBL	SBT	SBR
Lane Configurations												
Traffic Volume (veh/h)	156	832	512	184	214	2	155	413	149	42	659	61
Future Volume (veh/h)	156	832	512	184	214	2	155	413	149	42	659	61
Number	7	4	14	3	8	18	5	2	12	1	6	16
Initial Q (Qb), veh	0	0	0	0	0	0	0	0	0	0	0	0
Ped-Bike Adj(A_pbT)	0.99		0.96	1.00		0.97	1.00		0.98	1.00		0.98
Parking Bus, Adj	1.00	1.00	1.00	1.00	1.00	1.00	1.00	1.00	1.00	1.00	1.00	1.00
Adj Sat Flow, veh/h/ln	1863	1863	1863	1863	1863	1900	1863	1863	1863	1863	1863	1863
Adj Flow Rate, veh/h	156	832	421	184	214	2	155	413	106	42	659	35
Adj No. of Lanes	1	3	1	1	2	0	1	1	1	1	1	1
Peak Hour Factor	1.00	1.00	1.00	1.00	1.00	1.00	1.00	1.00	1.00	1.00	1.00	1.00
Percent Heavy Veh, %	2	2	2	2	2	2	2	2	2	2	2	2
Cap, veh/h	566	2191	657	252	1547	14	235	860	717	381	860	717
Arrive On Green	0.43	0.43	0.43	0.43	0.43	0.43	0.46	0.46	0.46	0.46	0.46	0.46
Sat Flow, veh/h	1153	5085	1525	441	3592	34	746	1863	1554	877	1863	1553
Grp Volume(v), veh/h	156	832	421	184	105	111	155	413	106	42	659	35
Grp Sat Flow(s),veh/h/ln	1153	1695	1525	441	1770	1856	746	1863	1554	877	1863	1553
Q Serve(g_s), s	6.2	7.2	14.1	20.8	2.3	2.3	10.8	10.0	2.6	2.3	19.2	0.8
Cycle Q Clear(g_c), s	8.5	7.2	14.1	28.0	2.3	2.3	30.0	10.0	2.6	12.2	19.2	0.8
Prop In Lane	1.00		1.00	1.00		0.02	1.00		1.00	1.00		1.00
Lane Grp Cap(c), veh/h	566	2191	657	252	762	799	235	860	717	381	860	717
V/C Ratio(X)	0.28	0.38	0.64	0.73	0.14	0.14	0.66	0.48	0.15	0.11	0.77	0.05
Avail Cap(c_a), veh/h	566	2191	657	252	762	799	235	860	717	381	860	717
HCM Platoon Ratio	1.00	1.00	1.00	1.00	1.00	1.00	1.00	1.00	1.00	1.00	1.00	1.00
Upstream Filter(I)	1.00	1.00	1.00	1.00	1.00	1.00	1.00	1.00	1.00	1.00	1.00	1.00
Uniform Delay (d), s/veh	13.8	12.6	14.5	24.6	11.2	11.2	28.1	12.1	10.1	16.3	14.6	9.6
Incr Delay (d2), s/veh	1.2	0.5	4.7	17.1	0.4	0.4	13.6	1.9	0.4	0.6	6.5	0.1
Initial Q Delay(d3),s/veh	0.0	0.0	0.0	0.0	0.0	0.0	0.0	0.0	0.0	0.0	0.0	0.0
%ile BackOfQ(50%),veh/ln	2.1	3.5	6.7	4.5	1.2	1.3	3.6	5.5	1.2	0.6	11.2	0.4
LnGrp Delay(d),s/veh	15.0	13.1	19.3	41.6	11.6	11.6	41.7	14.0	10.5	16.9	21.1	9.8
LnGrp LOS	B	B	B	D	B	B	D	B	B	B	C	A
Approach Vol, veh/h		1409			400			674			736	
Approach Delay, s/veh		15.2			25.4			19.9			20.3	
Approach LOS		B			C			B			C	
Timer	1	2	3	4	5	6	7	8				
Assigned Phs		2		4		6		8				
Phs Duration (G+Y+Rc), s		33.5		31.5		33.5		31.5				
Change Period (Y+Rc), s		3.5		3.5		3.5		3.5				
Max Green Setting (Gmax), s		30.0		28.0		30.0		28.0				
Max Q Clear Time (g_c+I1), s		32.0		16.1		21.2		30.0				
Green Ext Time (p_c), s		0.0		6.2		3.2		0.0				
Intersection Summary												
HCM 2010 Ctrl Delay				18.6								
HCM 2010 LOS				B								

15: E 8th St/14th Ave & E 12th St
 HCM 2010 Signalized Intersection Summary

03/14/2019

												
Movement	EBL	EBT	EBR	WBL	WBT	WBR	NBL	NBT	NBR	SBL	SBT	SBR
Lane Configurations												
Traffic Volume (veh/h)	154	188	4	0	0	0	0	505	0	234	179	0
Future Volume (veh/h)	154	188	4	0	0	0	0	505	0	234	179	0
Number	1	6	16				7	4	14	3	8	18
Initial Q (Qb), veh	0	0	0				0	0	0	0	0	0
Ped-Bike Adj(A_pbT)	1.00		1.00				1.00		1.00	1.00		1.00
Parking Bus, Adj	1.00	1.00	1.00				1.00	1.00	1.00	1.00	1.00	1.00
Adj Sat Flow, veh/h/ln	1881	1881	1900				0	1881	0	1881	1881	0
Adj Flow Rate, veh/h	154	188	0				0	505	0	234	179	0
Adj No. of Lanes	1	2	0				0	2	0	1	3	0
Peak Hour Factor	1.00	1.00	1.00				1.00	1.00	1.00	1.00	1.00	1.00
Percent Heavy Veh, %	1	1	1				0	1	0	1	1	0
Cap, veh/h	441	880	0				0	1645	0	613	3081	0
Arrive On Green	0.25	0.25	0.00				0.00	0.46	0.00	0.09	0.60	0.00
Sat Flow, veh/h	1792	3668	0				0	3762	0	1792	5305	0
Grp Volume(v), veh/h	154	188	0				0	505	0	234	179	0
Grp Sat Flow(s),veh/h/ln	1792	1787	0				0	1787	0	1792	1712	0
Q Serve(g_s), s	4.6	2.7	0.0				0.0	5.8	0.0	4.1	0.9	0.0
Cycle Q Clear(g_c), s	4.6	2.7	0.0				0.0	5.8	0.0	4.1	0.9	0.0
Prop In Lane	1.00		0.00				0.00		0.00	1.00		0.00
Lane Grp Cap(c), veh/h	441	880	0				0	1645	0	613	3081	0
V/C Ratio(X)	0.35	0.21	0.00				0.00	0.31	0.00	0.38	0.06	0.00
Avail Cap(c_a), veh/h	441	880	0				0	1645	0	803	3081	0
HCM Platoon Ratio	1.00	1.00	1.00				1.00	1.00	1.00	1.00	1.00	1.00
Upstream Filter(I)	1.00	1.00	0.00				0.00	1.00	0.00	1.00	1.00	0.00
Uniform Delay (d), s/veh	20.2	19.5	0.0				0.0	11.0	0.0	7.1	5.4	0.0
Incr Delay (d2), s/veh	2.2	0.6	0.0				0.0	0.5	0.0	0.1	0.0	0.0
Initial Q Delay(d3),s/veh	0.0	0.0	0.0				0.0	0.0	0.0	0.0	0.0	0.0
%ile BackOfQ(50%),veh/ln	2.5	1.4	0.0				0.0	2.9	0.0	1.9	0.4	0.0
LnGrp Delay(d),s/veh	22.4	20.0	0.0				0.0	11.5	0.0	7.2	5.4	0.0
LnGrp LOS	C	C						B		A	A	
Approach Vol, veh/h		342						505			413	
Approach Delay, s/veh		21.1						11.5			6.4	
Approach LOS		C						B			A	
Timer	1	2	3	4	5	6	7	8				
Assigned Phs			3	4		6		8				
Phs Duration (G+Y+Rc), s			9.1	34.9		21.0		44.0				
Change Period (Y+Rc), s			3.0	5.0		5.0		5.0				
Max Green Setting (Gmax), s			13.0	23.0		16.0		39.0				
Max Q Clear Time (g_c+I1), s			6.1	7.8		6.6		2.9				
Green Ext Time (p_c), s			0.0	0.6		0.2		0.3				
Intersection Summary												
HCM 2010 Ctrl Delay			12.4									
HCM 2010 LOS			B									

16: Foothill & 14th Ave
 HCM Signalized Intersection Capacity Analysis

03/14/2019



Movement	EBL	EBT	EBR	WBL	WBT	WBR	NBL	NBT	NBR	SBL	SBT	SBR
Lane Configurations					↑↑						↑↑	
Traffic Volume (vph)	0	0	0	36	141	0	0	0	0	139	679	85
Future Volume (vph)	0	0	0	36	141	0	0	0	0	139	679	85
Ideal Flow (vphpl)	1900	1900	1900	1900	1900	1900	1900	1900	1900	1900	1900	1900
Total Lost time (s)					4.5						4.0	
Lane Util. Factor					0.95						0.95	
Frbp, ped/bikes					1.00						1.00	
Flpb, ped/bikes					1.00						1.00	
Frt					1.00						0.99	
Flt Protected					0.99						0.99	
Satd. Flow (prot)					3504						3454	
Flt Permitted					0.99						0.99	
Satd. Flow (perm)					3504						3454	
Peak-hour factor, PHF	1.00	1.00	1.00	1.00	1.00	1.00	1.00	1.00	1.00	1.00	1.00	1.00
Adj. Flow (vph)	0	0	0	36	141	0	0	0	0	139	679	85
RTOR Reduction (vph)	0	0	0	0	0	0	0	0	0	0	10	0
Lane Group Flow (vph)	0	0	0	0	177	0	0	0	0	0	893	0
Confl. Peds. (#/hr)	13		13			13	16		1			16
Confl. Bikes (#/hr)						10						2
Turn Type				Split	NA					Split	NA	
Protected Phases				5	5					6	6	
Permitted Phases												
Actuated Green, G (s)					4.3						31.0	
Effective Green, g (s)					4.3						31.0	
Actuated g/C Ratio					0.08						0.56	
Clearance Time (s)					4.5						4.0	
Vehicle Extension (s)					3.0						0.2	
Lane Grp Cap (vph)					273						1946	
v/s Ratio Prot					c0.05						c0.26	
v/s Ratio Perm												
v/c Ratio					0.65						0.46	
Uniform Delay, d1					24.6						7.1	
Progression Factor					1.77						1.00	
Incremental Delay, d2					5.2						0.8	
Delay (s)					48.6						7.8	
Level of Service					D						A	
Approach Delay (s)		0.0			48.6			0.0			7.8	
Approach LOS		A			D			A			A	
Intersection Summary												
HCM 2000 Control Delay			14.5		HCM 2000 Level of Service					B		
HCM 2000 Volume to Capacity ratio			0.41									
Actuated Cycle Length (s)			55.0		Sum of lost time (s)					14.0		
Intersection Capacity Utilization			44.7%		ICU Level of Service					A		
Analysis Period (min)			15									
c Critical Lane Group												

17: 14th Ave & Foothill Blvd
 HCM Signalized Intersection Capacity Analysis

03/14/2019



Movement	EBL	EBT	EBR	WBL	WBT	WBR	NBL	NBT	NBR	SBL	SBT	SBR
Lane Configurations		↑↑			↑↑			↑↑				
Traffic Volume (vph)	10	129	0	0	178	2	0	902	168	0	0	0
Future Volume (vph)	10	129	0	0	178	2	0	902	168	0	0	0
Ideal Flow (vphpl)	1900	1900	1900	1900	1900	1900	1900	1900	1900	1900	1900	1900
Total Lost time (s)		5.5			5.5			4.0				
Lane Util. Factor		0.95			0.95			0.95				
Frbp, ped/bikes		1.00			1.00			1.00				
Flpb, ped/bikes		1.00			1.00			1.00				
Frt		1.00			1.00			0.98				
Flt Protected		1.00			1.00			1.00				
Satd. Flow (prot)		3527			3532			3446				
Flt Permitted		0.94			1.00			1.00				
Satd. Flow (perm)		3310			3532			3446				
Peak-hour factor, PHF	1.00	1.00	1.00	1.00	1.00	1.00	1.00	1.00	1.00	1.00	1.00	1.00
Adj. Flow (vph)	10	129	0	0	178	2	0	902	168	0	0	0
RTOR Reduction (vph)	0	0	0	0	2	0	0	21	0	0	0	0
Lane Group Flow (vph)	0	139	0	0	178	0	0	1049	0	0	0	0
Confl. Peds. (#/hr)			5	5		10			3	3		
Confl. Bikes (#/hr)			1			10			8			
Turn Type	custom	NA			NA			NA				
Protected Phases	1	4 1			8			2				
Permitted Phases	4											
Actuated Green, G (s)		10.3			5.7			30.7				
Effective Green, g (s)		10.3			5.7			30.7				
Actuated g/C Ratio		0.19			0.10			0.56				
Clearance Time (s)					5.5			4.0				
Vehicle Extension (s)					0.2			0.2				
Lane Grp Cap (vph)		638			366			1923				
v/s Ratio Prot		c0.02			c0.05			c0.30				
v/s Ratio Perm		0.02										
v/c Ratio		0.22			0.49			0.55				
Uniform Delay, d1		18.9			23.3			7.7				
Progression Factor		1.80			1.00			1.00				
Incremental Delay, d2		0.1			0.4			1.1				
Delay (s)		34.1			23.6			8.8				
Level of Service		C			C			A				
Approach Delay (s)		34.1			23.6			8.8			0.0	
Approach LOS		C			C			A			A	
Intersection Summary												
HCM 2000 Control Delay			13.3									B
HCM 2000 Volume to Capacity ratio			0.50									
Actuated Cycle Length (s)			55.0									14.0
Intersection Capacity Utilization			49.4%									A
Analysis Period (min)			15									
c Critical Lane Group												

18: 23rd Ave & 16th St
 HCM Signalized Intersection Capacity Analysis

03/14/2019



Movement	WBL	WBR	NBT	NBR	SBL	SBT
Lane Configurations	W		T			T
Traffic Volume (vph)	22	42	337	22	24	319
Future Volume (vph)	22	42	337	22	24	319
Ideal Flow (vphpl)	1900	1900	1900	1900	1900	1900
Total Lost time (s)	4.5		4.0			4.0
Lane Util. Factor	1.00		1.00			1.00
Frbp, ped/bikes	0.97		0.99			1.00
Flpb, ped/bikes	1.00		1.00			1.00
Frt	0.91		0.99			1.00
Flt Protected	0.98		1.00			1.00
Satd. Flow (prot)	1622		1835			1850
Flt Permitted	0.98		1.00			0.96
Satd. Flow (perm)	1622		1835			1789
Peak-hour factor, PHF	1.00	1.00	1.00	1.00	1.00	1.00
Adj. Flow (vph)	22	42	337	22	24	319
RTOR Reduction (vph)	37	0	4	0	0	0
Lane Group Flow (vph)	27	0	355	0	0	343
Confl. Peds. (#/hr)		3		62	62	
Confl. Bikes (#/hr)		3		7		
Turn Type	Prot		NA		Perm	NA
Protected Phases	7		2			2
Permitted Phases					2	
Actuated Green, G (s)	5.7		19.8			19.8
Effective Green, g (s)	5.7		19.8			19.8
Actuated g/C Ratio	0.11		0.38			0.38
Clearance Time (s)	4.5		4.0			4.0
Vehicle Extension (s)	3.0		3.0			3.0
Lane Grp Cap (vph)	179		704			686
v/s Ratio Prot	c0.02		c0.19			
v/s Ratio Perm						0.19
v/c Ratio	0.15		0.50			0.50
Uniform Delay, d1	20.8		12.2			12.1
Progression Factor	1.00		1.00			0.25
Incremental Delay, d2	0.4		0.6			0.5
Delay (s)	21.1		12.7			3.5
Level of Service	C		B			A
Approach Delay (s)	21.1		12.7			3.5
Approach LOS	C		B			A












Intersection Summary

HCM 2000 Control Delay	9.3	HCM 2000 Level of Service	A
HCM 2000 Volume to Capacity ratio	0.28		
Actuated Cycle Length (s)	51.6	Sum of lost time (s)	12.5
Intersection Capacity Utilization	47.8%	ICU Level of Service	A
Analysis Period (min)	15		

c Critical Lane Group












19: 7th Ave & Embarcadero W
 HCM 2010 Signalized Intersection Summary

03/14/2019

									
Movement	EBT	EBR	WBL	WBT	NBL	NBR			
Lane Configurations									
Traffic Volume (veh/h)	2114	185	102	569	280	33			
Future Volume (veh/h)	2114	185	102	569	280	33			
Number	4	14	3	8	5	12			
Initial Q (Qb), veh	0	0	0	0	0	0			
Ped-Bike Adj(A_pbT)		0.83	0.99		1.00	1.00			
Parking Bus, Adj	1.00	1.00	1.00	1.00	1.00	1.00			
Adj Sat Flow, veh/h/ln	1863	1900	1863	1863	1863	1863			
Adj Flow Rate, veh/h	2114	185	102	569	280	28			
Adj No. of Lanes	2	0	1	2	1	1			
Peak Hour Factor	1.00	1.00	1.00	1.00	1.00	1.00			
Percent Heavy Veh, %	2	2	2	2	2	2			
Cap, veh/h	2447	207	185	2670	290	259			
Arrive On Green	1.00	1.00	1.00	1.00	0.16	0.16			
Sat Flow, veh/h	3336	274	159	3632	1774	1583			
Grp Volume(v), veh/h	1120	1179	102	569	280	28			
Grp Sat Flow(s),veh/h/ln	1770	1747	159	1770	1774	1583			
Q Serve(g_s), s	0.0	0.0	0.0	0.0	17.2	1.7			
Cycle Q Clear(g_c), s	0.0	0.0	0.0	0.0	17.2	1.7			
Prop In Lane		0.16	1.00		1.00	1.00			
Lane Grp Cap(c), veh/h	1335	1318	185	2670	290	259			
V/C Ratio(X)	0.84	0.89	0.55	0.21	0.96	0.11			
Avail Cap(c_a), veh/h	1335	1318	185	2670	290	259			
HCM Platoon Ratio	2.00	2.00	2.00	2.00	1.00	1.00			
Upstream Filter(I)	0.09	0.09	0.88	0.88	1.00	1.00			
Uniform Delay (d), s/veh	0.0	0.0	0.0	0.0	45.7	39.2			
Incr Delay (d2), s/veh	0.6	1.0	10.0	0.2	44.5	0.8			
Initial Q Delay(d3),s/veh	0.0	0.0	0.0	0.0	0.0	0.0			
%ile BackOfQ(50%),veh/ln	0.2	0.4	0.5	0.1	12.1	0.8			
LnGrp Delay(d),s/veh	0.6	1.0	10.0	0.2	90.2	40.0			
LnGrp LOS	A	A	A	A	F	D			
Approach Vol, veh/h	2299			671	308				
Approach Delay, s/veh	0.8			1.6	85.6				
Approach LOS	A			A	F				
Timer	1	2	3	4	5	6	7	8	
Assigned Phs	2		4		8				
Phs Duration (G+Y+Rc), s	22.5		87.5		87.5				
Change Period (Y+Rc), s	4.5		4.5		4.5				
Max Green Setting (Gmax), s	18.0		83.0		83.0				
Max Q Clear Time (g_c+I1), s	19.2		2.0		2.0				
Green Ext Time (p_c), s	0.0		52.4		14.0				
Intersection Summary									
HCM 2010 Ctrl Delay			9.0						
HCM 2010 LOS			A						

20: 8th Ave & Embarcadero W
 HCM 2010 Signalized Intersection Summary

03/14/2019

								
Movement	EBT	EBR	WBL	WBT	NBL	NBR		
Lane Configurations								
Traffic Volume (veh/h)	1962	185	103	445	226	33		
Future Volume (veh/h)	1962	185	103	445	226	33		
Number	4	14	3	8	5	12		
Initial Q (Qb), veh	0	0	0	0	0	0		
Ped-Bike Adj(A_pbT)		1.00	1.00		1.00	1.00		
Parking Bus, Adj	1.00	1.00	1.00	1.00	1.00	1.00		
Adj Sat Flow, veh/h/ln	1863	1900	1863	1863	1863	1863		
Adj Flow Rate, veh/h	1962	185	103	445	226	6		
Adj No. of Lanes	2	0	1	1	1	1		
Peak Hour Factor	1.00	1.00	1.00	1.00	1.00	1.00		
Percent Heavy Veh, %	2	2	2	2	2	2		
Cap, veh/h	2471	229	205	1406	290	259		
Arrive On Green	1.00	1.00	1.00	1.00	0.16	0.16		
Sat Flow, veh/h	3368	304	186	1863	1774	1583		
Grp Volume(v), veh/h	1046	1101	103	445	226	6		
Grp Sat Flow(s),veh/h/ln	1770	1809	186	1863	1774	1583		
Q Serve(g_s), s	0.0	0.0	0.0	0.0	13.4	0.3		
Cycle Q Clear(g_c), s	0.0	0.0	0.0	0.0	13.4	0.3		
Prop In Lane		0.17	1.00		1.00	1.00		
Lane Grp Cap(c), veh/h	1335	1365	205	1406	290	259		
V/C Ratio(X)	0.78	0.81	0.50	0.32	0.78	0.02		
Avail Cap(c_a), veh/h	1335	1365	205	1406	290	259		
HCM Platoon Ratio	2.00	2.00	2.00	2.00	1.00	1.00		
Upstream Filter(I)	0.30	0.30	1.00	1.00	1.00	1.00		
Uniform Delay (d), s/veh	0.0	0.0	0.0	0.0	44.1	38.6		
Incr Delay (d2), s/veh	1.4	1.6	8.5	0.6	18.4	0.2		
Initial Q Delay(d3),s/veh	0.0	0.0	0.0	0.0	0.0	0.0		
%ile BackOfQ(50%),veh/ln	0.5	0.6	0.5	0.2	8.1	0.2		
LnGrp Delay(d),s/veh	1.4	1.6	8.5	0.6	62.5	38.8		
LnGrp LOS	A	A	A	A	E	D		
Approach Vol, veh/h	2147			548	232			
Approach Delay, s/veh	1.5			2.1	61.9			
Approach LOS	A			A	E			
Timer	1	2	3	4	5	6	7	8
Assigned Phs		2		4				8
Phs Duration (G+Y+Rc), s		22.5		87.5				87.5
Change Period (Y+Rc), s		4.5		4.5				4.5
Max Green Setting (Gmax), s		18.0		83.0				83.0
Max Q Clear Time (g_c+I1), s		15.4		2.0				2.0
Green Ext Time (p_c), s		0.2		44.0				10.6
Intersection Summary								
HCM 2010 Ctrl Delay			6.4					
HCM 2010 LOS			A					

Intersection						
Int Delay, s/veh	0.3					
Movement	EBT	EBR	WBL	WBT	NBL	NBR
Lane Configurations	↑↑			↑		↑
Traffic Vol, veh/h	1811	184	0	548	0	32
Future Vol, veh/h	1811	184	0	548	0	32
Conflicting Peds, #/hr	0	20	0	0	0	0
Sign Control	Free	Free	Free	Free	Stop	Stop
RT Channelized	-	None	-	None	-	None
Storage Length	-	-	-	-	-	0
Veh in Median Storage, #	0	-	-	0	0	-
Grade, %	0	-	-	0	0	-
Peak Hour Factor	100	100	100	100	100	100
Heavy Vehicles, %	2	2	2	2	2	2
Mvmt Flow	1811	184	0	548	0	32












Major/Minor	Major1	Major2	Minor1
Conflicting Flow All	0	0	- - - 1018
Stage 1	-	-	- - -
Stage 2	-	-	- - -
Critical Hdwy	-	-	- - - 6.93
Critical Hdwy Stg 1	-	-	- - -
Critical Hdwy Stg 2	-	-	- - -
Follow-up Hdwy	-	-	- - - 3.319
Pot Cap-1 Maneuver	-	- 0	- 0 236
Stage 1	-	- 0	- 0 -
Stage 2	-	- 0	- 0 -
Platoon blocked, %	-	-	-
Mov Cap-1 Maneuver	-	-	- - - 232
Mov Cap-2 Maneuver	-	-	- - -
Stage 1	-	-	- - -
Stage 2	-	-	- - -

Approach	EB	WB	NB
HCM Control Delay, s	0	0	23
HCM LOS			C

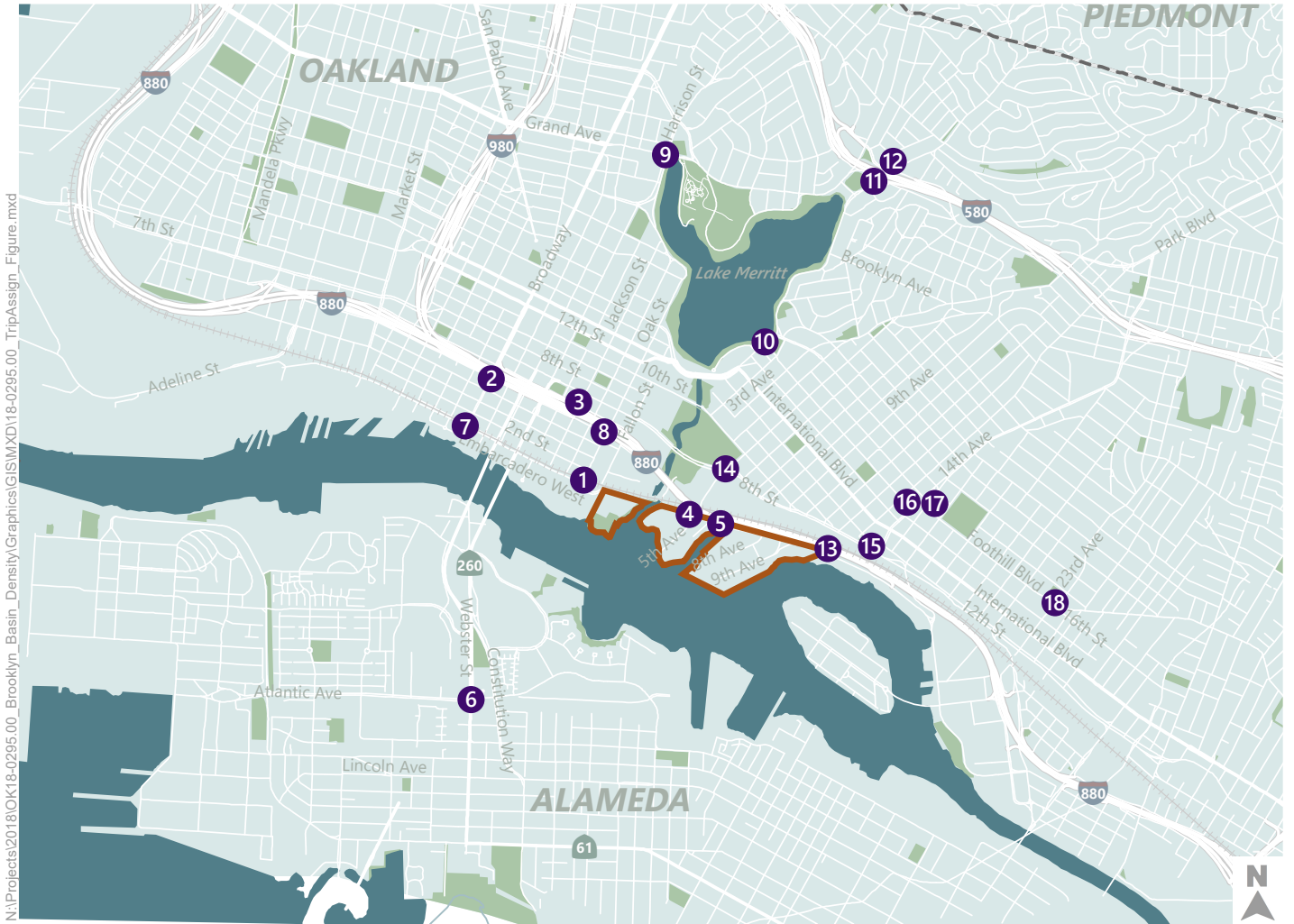
Minor Lane/Major Mvmt	NBLn1	EBT	EBR	WBT
Capacity (veh/h)	232	-	-	-
HCM Lane V/C Ratio	0.138	-	-	-
HCM Control Delay (s)	23	-	-	-
HCM Lane LOS	C	-	-	-
HCM 95th %tile Q(veh)	0.5	-	-	-

22: 4th Ave & Embarcadero W
 HCM 2010 Signalized Intersection Summary

03/14/2019

								
Movement	EBT	EBR	WBL	WBT	NBL	NBR		
Lane Configurations								
Traffic Volume (veh/h)	1074	79	120	813	39	40		
Future Volume (veh/h)	1074	79	120	813	39	40		
Number	4	14	3	8	5	12		
Initial Q (Qb), veh	0	0	0	0	0	0		
Ped-Bike Adj(A_pbT)		0.83	1.00		1.00	1.00		
Parking Bus, Adj	1.00	1.00	1.00	1.00	1.00	1.00		
Adj Sat Flow, veh/h/ln	1863	1900	1863	1863	1863	1863		
Adj Flow Rate, veh/h	1074	79	120	813	39	7		
Adj No. of Lanes	1	0	1	2	1	1		
Peak Hour Factor	1.00	1.00	1.00	1.00	1.00	1.00		
Percent Heavy Veh, %	2	2	2	2	2	2		
Cap, veh/h	1272	94	223	2670	290	259		
Arrive On Green	0.75	0.75	1.00	1.00	0.16	0.16		
Sat Flow, veh/h	1686	124	485	3632	1774	1583		
Grp Volume(v), veh/h	0	1153	120	813	39	7		
Grp Sat Flow(s),veh/h/ln	0	1810	485	1770	1774	1583		
Q Serve(g_s), s	0.0	47.4	23.1	0.0	2.1	0.4		
Cycle Q Clear(g_c), s	0.0	47.4	70.4	0.0	2.1	0.4		
Prop In Lane		0.07	1.00		1.00	1.00		
Lane Grp Cap(c), veh/h	0	1366	223	2670	290	259		
V/C Ratio(X)	0.00	0.84	0.54	0.30	0.13	0.03		
Avail Cap(c_a), veh/h	0	1366	223	2670	290	259		
HCM Platoon Ratio	1.00	1.00	2.00	2.00	1.00	1.00		
Upstream Filter(I)	0.00	1.00	0.09	0.09	1.00	1.00		
Uniform Delay (d), s/veh	0.0	9.1	20.1	0.0	39.3	38.6		
Incr Delay (d2), s/veh	0.0	6.5	0.8	0.0	1.0	0.2		
Initial Q Delay(d3),s/veh	0.0	0.0	0.0	0.0	0.0	0.0		
%ile BackOfQ(50%),veh/ln	0.0	25.5	3.1	0.0	1.1	0.2		
LnGrp Delay(d),s/veh	0.0	15.7	20.9	0.0	40.3	38.8		
LnGrp LOS		B	C	A	D	D		
Approach Vol, veh/h	1153			933	46			
Approach Delay, s/veh	15.7			2.7	40.1			
Approach LOS	B			A	D			
Timer	1	2	3	4	5	6	7	8
Assigned Phs		2		4				8
Phs Duration (G+Y+Rc), s		22.5		87.5				87.5
Change Period (Y+Rc), s		4.5		4.5				4.5
Max Green Setting (Gmax), s		18.0		83.0				83.0
Max Q Clear Time (g_c+I1), s		4.1		49.4				72.4
Green Ext Time (p_c), s		0.1		14.1				5.1
Intersection Summary								
HCM 2010 Ctrl Delay			10.5					
HCM 2010 LOS			B					

Attachment C
Peak Hour Volumes and Lane
Configurations

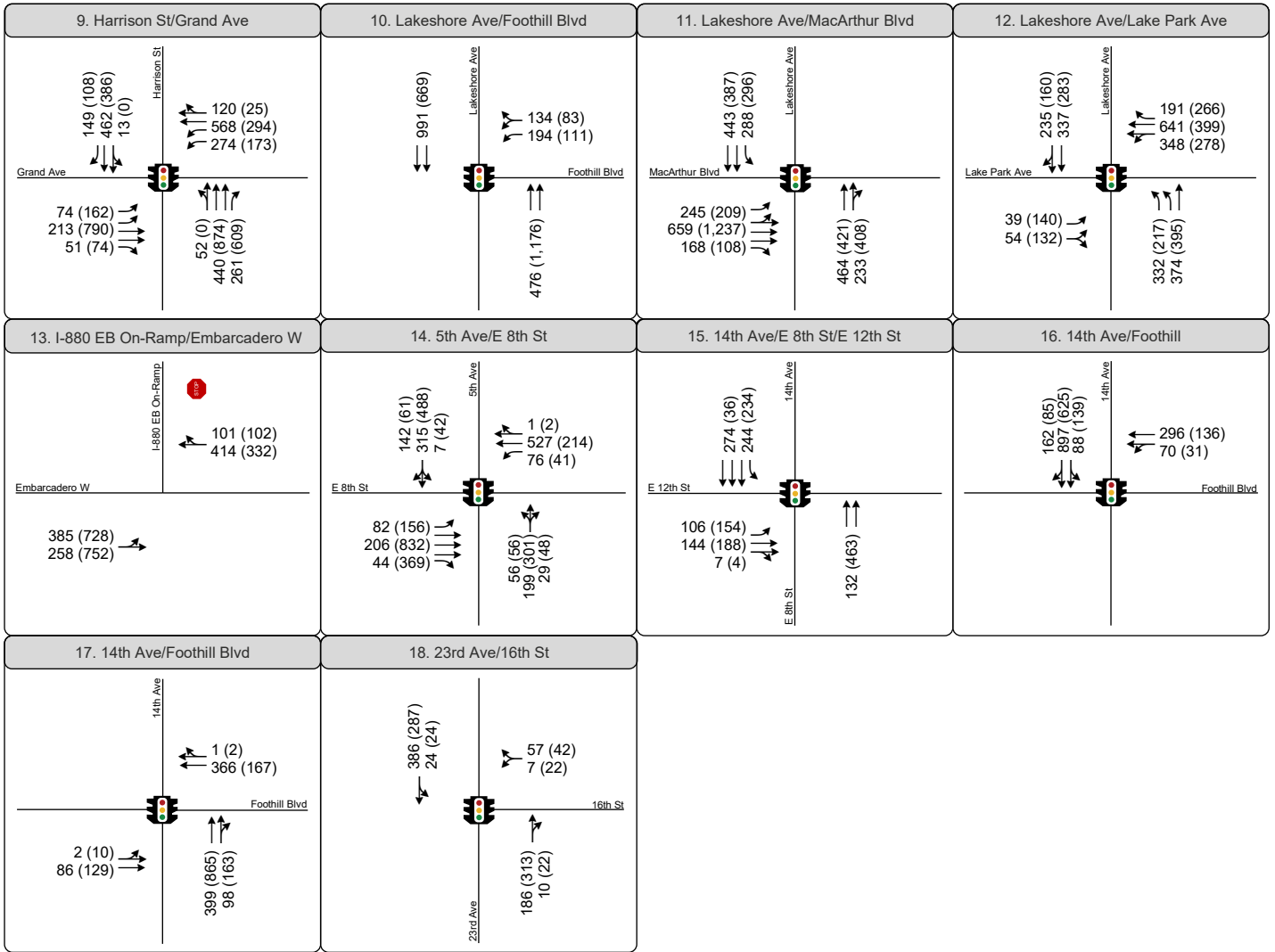


1. Oak St/Embarcadero W/Embarcadero W	2. Broadway/5th Street	3. Jackson St/6th Street	4. 5th Ave/Embarcadero W
<p>Embarcadero W</p> <p>21 (31) 154 (532)</p> <p>Oak St</p> <p>Embarcadero W</p> <p>79 (138) 24 (43)</p> <p>Embarcadero W</p> <p>53 (63) 394 (362)</p>	<p>Broadway</p> <p>189 (232) 114 (144) 204 (361)</p> <p>Webster Street Tube/Alameda</p> <p>5th Street</p> <p>16 (5) 146 (329) 713 (791) 50 (17)</p> <p>129 (239) 55 (50) 170 (381)</p>	<p>6th Street</p> <p>1,066 (999) 399 (286) 131 (150)</p> <p>Jackson St</p> <p>101 (83) 301 (303) 15 (8)</p> <p>171 (244) 390 (500)</p>	<p>5th Ave</p> <p>7 (21) 1 (18) 407 (952)</p> <p>Embarcadero W</p> <p>274 (319) 403 (363) 5 (6)</p> <p>Embarcadero W</p> <p>5 (14) 161 (525) 0 (2)</p> <p>0 (1) 10 (10) 0 (10)</p>
5. I-880 WB Off-Ramp/Embarcadero W	6. Webster St/Atlantic Ave	7. Broadway/Embarcadero W	8. Oak St/5th Street
<p>I-880 WB Off-Ramp</p> <p>268 (372) 0 (0) 75 (72)</p> <p>← 414 (332)</p> <p>Embarcadero W</p> <p>568 (1,408)</p> <p>5th Ave</p>	<p>Webster St</p> <p>315 (266) 364 (792) 84 (168)</p> <p>Atlantic Ave</p> <p>46 (105) 374 (259) 23 (60)</p> <p>172 (154) 300 (312) 146 (152)</p> <p>140 (110) 537 (441) 66 (57)</p>	<p>Embarcadero W</p> <p>7 (34) 19 (78) 32 (67)</p> <p>Broadway</p> <p>60 (100) 71 (39) 5 (13)</p> <p>9 (24) 29 (150) 6 (45)</p> <p>2 (13) 9 (62) 3 (14)</p>	<p>Oak St</p> <p>47 (19) 2 (3)</p> <p>5th Street</p> <p>291 (421) 485 (801) 132 (87)</p> <p>129 (235) 61 (194)</p>

Peak Hour Volumes and Lane Configurations

Existing (2018) Conditions

- with Approved Project
- with Proposed Project



Peak Hour Volumes and Lane Configurations

Existing (2018) Conditions

- with Approved Project
- with Proposed Project



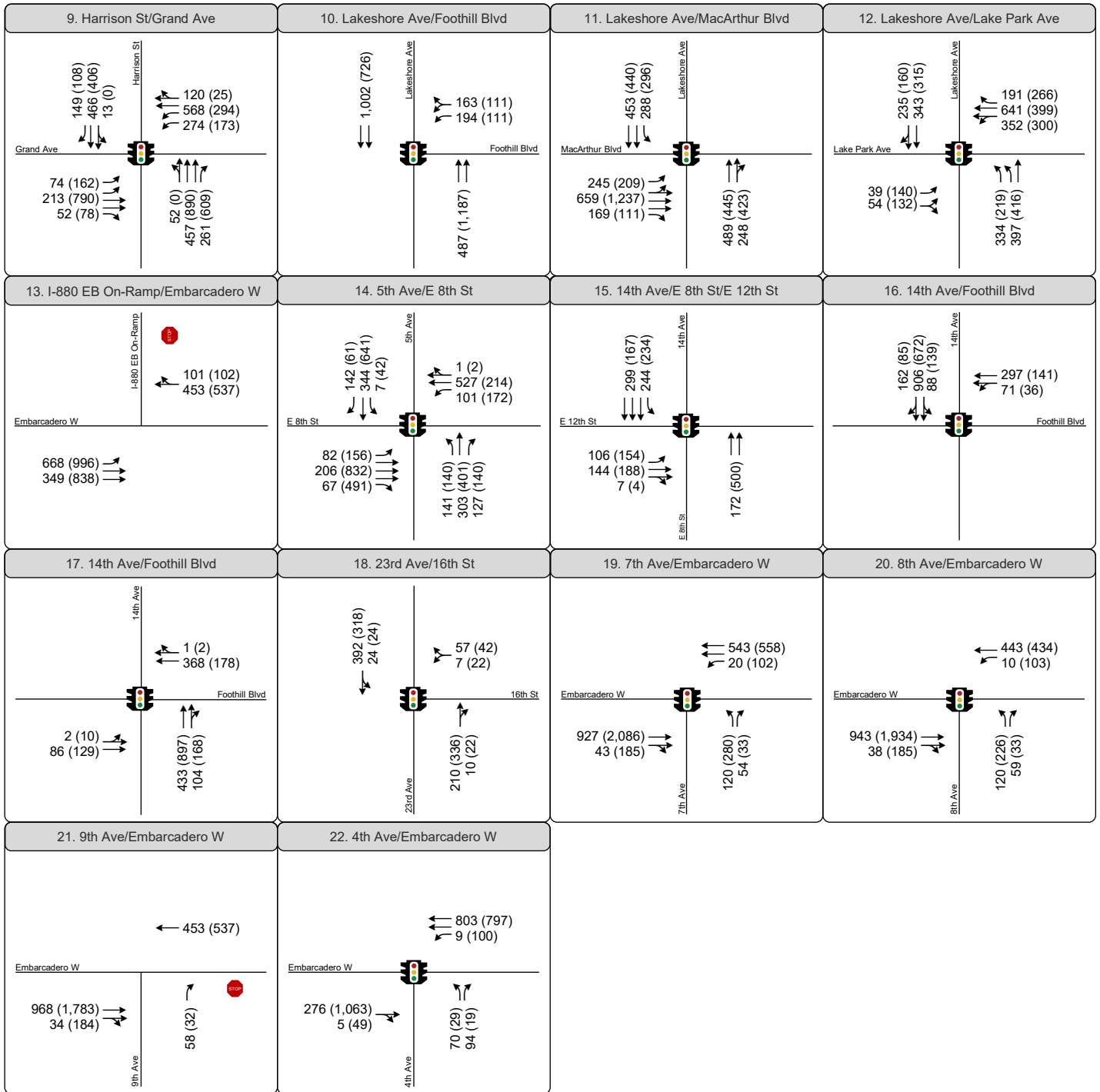


1. Oak St/Embarcadero W/Embarcadero W	2. Broadway/5th Street	3. Jackson St/6th Street	4. 5th Ave/Embarcadero W
5. 880 Off-Ramp/6th Ave/Embarcadero W	6. Webster St/Atlantic Ave	7. Broadway/Embarcadero W	8. Oak St/5th Street

Peak Hour Volumes and Lane Configurations

Existing (2018) Conditions

- with Approved Project
- with Proposed Project

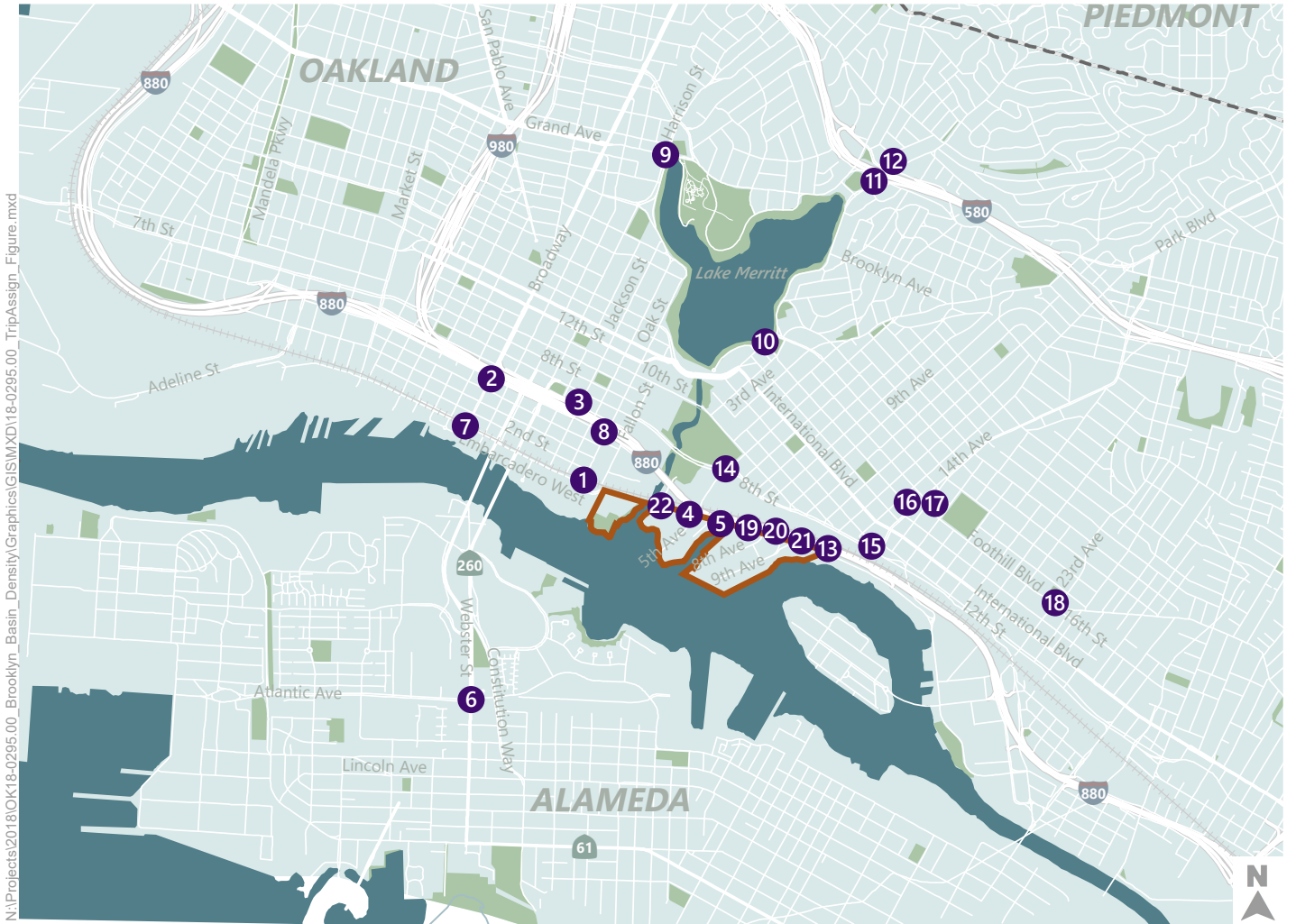


Peak Hour Volumes and Lane Configurations

Existing (2018) Conditions

- with Approved Project
- with Proposed Project



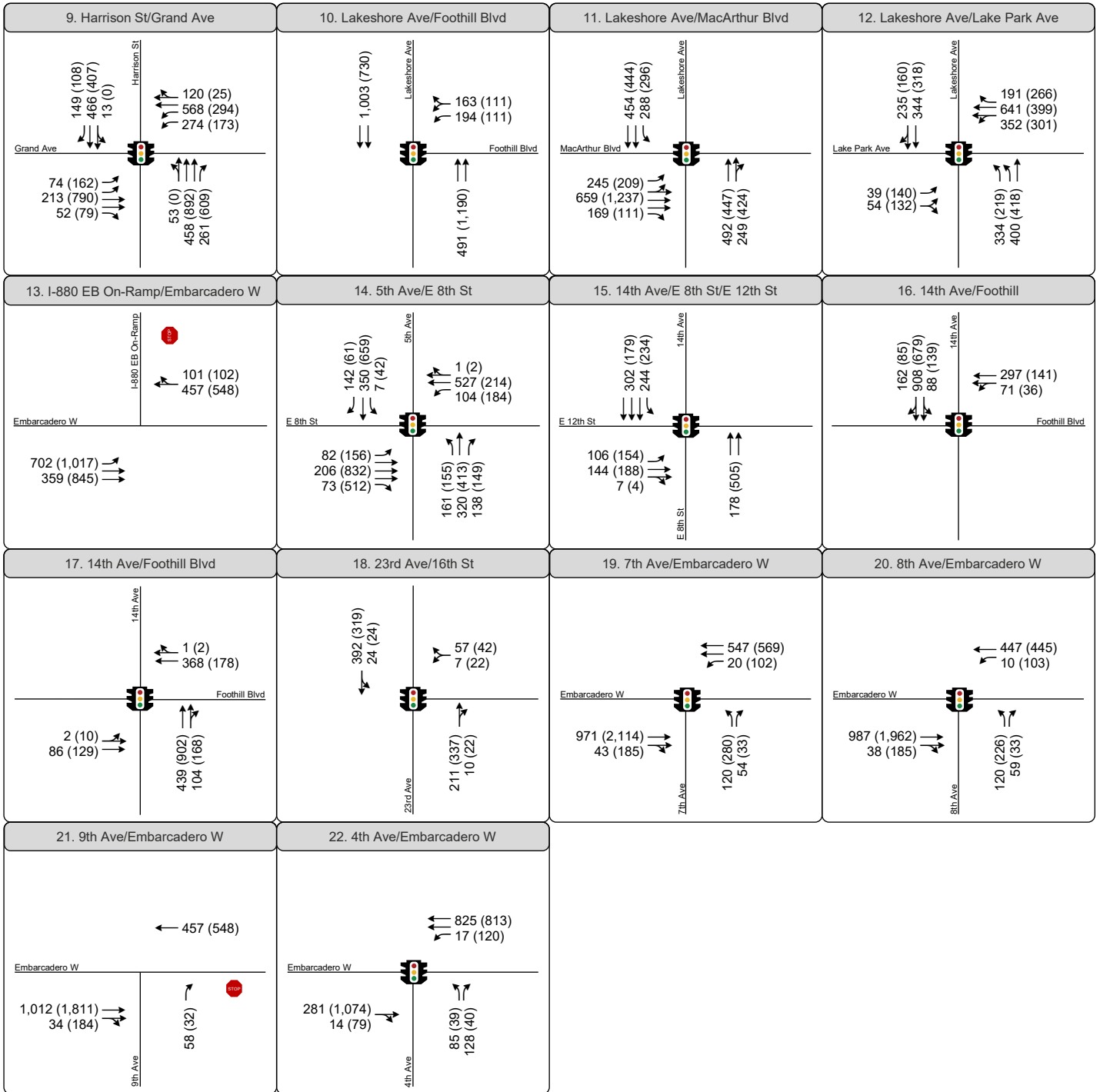


1. Oak St/Embarcadero W/Embarcadero W	2. Broadway/5th Street	3. Jackson St/6th Street	4. 5th Ave/Embarcadero W								
<p>21 (31) 217 (843)</p> <p>79 (138) 84 (344)</p> <p>259 (247) 697 (635)</p>	<p>218 (386) 114 (144) 204 (361)</p> <p>16 (5) 146 (329) 713 (791) 52 (24)</p> <p>238 (342) 55 (50) 170 (381)</p>	<p>1,066 (999) 412 (295) 139 (189)</p> <p>112 (84) 527 (517) 15 (8)</p> <p>184 (253) 415 (525)</p>	<p>22 (75) 21 (93) 465 (1,279)</p> <p>474 (557) 732 (813) 35 (103)</p> <p>68 (47) 322 (1,003) 19 (64)</p> <p>88 (45) 82 (50) 83</p>	5. 880 Off-Ramp/6th Ave/Embarcadero W	6. Webster St/Atlantic Ave	7. Broadway/Embarcadero W	8. Oak St/5th Street	<p>302 (493) 25 (123) 98 (258)</p> <p>654 (783) 13 (66)</p> <p>788 (1,940) 65 (317)</p> <p>270 (212) 128 (101)</p>	<p>353 (301) 371 (798) 91 (174)</p> <p>46 (106) 374 (259) 23 (60)</p> <p>178 (182) 305 (336) 146 (152)</p> <p>140 (110) 539 (450) 66 (57)</p>	<p>7 (34) 19 (78) 63 (228)</p> <p>169 (203) 72 (40) 99 (101)</p> <p>9 (24) 32 (158) 6 (45)</p> <p>2 (13) 9 (62) 28 (143)</p>	<p>47 (19) 2 (3)</p> <p>291 (421) 485 (801) 193 (392)</p> <p>389 (471) 61 (194)</p>
5. 880 Off-Ramp/6th Ave/Embarcadero W	6. Webster St/Atlantic Ave	7. Broadway/Embarcadero W	8. Oak St/5th Street								
<p>302 (493) 25 (123) 98 (258)</p> <p>654 (783) 13 (66)</p> <p>788 (1,940) 65 (317)</p> <p>270 (212) 128 (101)</p>	<p>353 (301) 371 (798) 91 (174)</p> <p>46 (106) 374 (259) 23 (60)</p> <p>178 (182) 305 (336) 146 (152)</p> <p>140 (110) 539 (450) 66 (57)</p>	<p>7 (34) 19 (78) 63 (228)</p> <p>169 (203) 72 (40) 99 (101)</p> <p>9 (24) 32 (158) 6 (45)</p> <p>2 (13) 9 (62) 28 (143)</p>	<p>47 (19) 2 (3)</p> <p>291 (421) 485 (801) 193 (392)</p> <p>389 (471) 61 (194)</p>								

Peak Hour Volumes and Lane Configurations

Existing (2018) Conditions

- with Approved Project
- with Proposed Project



Peak Hour Volumes and Lane Configurations

Existing (2018) Conditions

- with Approved Project
- with Proposed Project



Attachment D
HCM Predicted Collision Frequency Sheets

Worksheet 2A -- General Information and Input Data for Urban and Suburban Arterial Intersections						
General Information			Location Information			
Analyst	SZ		Intersection ID	1		
Agency or Company	Fehr & Peers		Intersection	Embarcadero/5th Avenue		
Date Performed	12/26/18		Jurisdiction	Oakland, CA		
			Analysis Year	2018		
Input Data			Base Conditions	Site Conditions		
Intersection type (3ST, 3SG, 4ST, 4SG)			--	4ST		
AADT _{major} (veh/day)	AADT _{MAX} = 46,800 (veh/day)		--	21,750		
AADT _{minor} (veh/day)	AADT _{MAX} = 5,900 (veh/day)		--	13,340		
Intersection lighting (present/not present)			Not Present	Not Present		
Calibration factor, C _i			1.00	1.00		
Data for unsignalized intersections only:			--	--		
Number of major-road approaches with left-turn lanes (0,1,2)			0	0		
Number of major-road approaches with right-turn lanes (0,1,2)			0	0		
Data for signalized intersections only:			--	--		
Number of approaches with left-turn lanes (0,1,2,3,4) [for 3SG, use maximum value of 3]			0			
Number of approaches with right-turn lanes (0,1,2,3,4) [for 3SG, use maximum value of 3]			0			
Number of approaches with left-turn signal phasing [for 3SG, use maximum value of 3]			--			
Type of left-turn signal phasing for Leg #1			Permissive			
Type of left-turn signal phasing for Leg #2			--			
Type of left-turn signal phasing for Leg #3			--			
Type of left-turn signal phasing for Leg #4 (if applicable)			--			
Number of approaches with right-turn-on-red prohibited [for 3SG, use maximum value of 3]			0			
Intersection red light cameras (present/not present)			Not Present			
Sum of all pedestrian crossing volumes (PedVol) -- Signalized intersections only						
Maximum number of lanes crossed by a pedestrian (n _{lanesx})			--			
Number of bus stops within 300 m (1,000 ft) of the intersection			0			
Schools within 300 m (1,000 ft) of the intersection (present/not present)			Not Present			
Number of alcohol sales establishments within 300 m (1,000 ft) of the intersection			0			

Worksheet 2B -- Crash Modification Factors for Urban and Suburban Arterial Intersections						
(1)	(2)	(3)	(4)	(5)	(6)	(7)
CMF for Left-Turn Lanes	CMF for Left-Turn Signal Phasing	CMF for Right-Turn Lanes	CMF for Right Turn on Red	CMF for Lighting	CMF for Red Light Cameras	Combined CMF
CMF _{1i}	CMF _{2i}	CMF _{3i}	CMF _{4i}	CMF _{5i}	CMF _{6i}	CMF _{COMB}
from Table 12-24	from Table 12-25	from Table 12-26	from Equation 12-35	from Equation 12-36	from Equation 12-37	(1)*(2)*(3)*(4)*(5)*(6)
1.00	1.00	1.00	1.00	1.00	0.97	0.97

Worksheet 2C -- Multiple-Vehicle Collisions by Severity Level for Urban and Suburban Arterial Intersections															
(1)	(2)			(3)	(4)	(5)	(6)	(7)	(8)	(9)					
Crash Severity Level	SPF Coefficients			Overdispersion Parameter, k	Initial N_{bimv}	Proportion of Total Crashes	Adjusted N_{bimv}	Combined CMFs	Calibration Factor, C_i	Predicted N_{bimv}					
	from Table 12-10										from Table 12-10	from Equation 12-21	$(4)_{TOTAL} * (5)$	(7) from Worksheet	$(6) * (7) * (8)$
	a	b	c												
Total	-8.90	0.82	0.25	0.40	5.282	1.000	5.282	0.97	1.00	5.115					
Fatal and Injury (FI)	-11.13	0.93	0.28	0.48	2.266	$(4)_{FI} / ((4)_{FI} + (4)_{PDO})$ 0.421	2.226	0.97	1.00	2.155					
Property Damage Only (PDO)	-8.74	0.77	0.23	0.40	3.111	$(5)_{TOTAL} - (5)_{FI}$ 0.579	3.056	0.97	1.00	2.960					

Worksheet 2D -- Multiple-Vehicle Collisions by Collision Type for Urban and Suburban Arterial Intersections					
(1)	(2)	(3)	(4)	(5)	(6)
Collision Type	Proportion of Collision Type _(FI)	Predicted $N_{bimv (FI)}$ (crashes/year)	Proportion of Collision Type _(PDO)	Predicted $N_{bimv (PDO)}$ (crashes/year)	Predicted $N_{bimv (TOTAL)}$ (crashes/year)
	from Table 12-11	$(9)_{FI}$ from Worksheet 2C	from Table 12-11	$(9)_{PDO}$ from Worksheet 2C	$(9)_{PDO}$ from Worksheet 2C
Total	1.000	2.155	1.000	2.960	5.115
		$(2) * (3)_{FI}$		$(4) * (5)_{PDO}$	$(3) + (5)$
Rear-end collision	0.338	0.729	0.374	1.107	1.835
Head-on collision	0.041	0.088	0.030	0.089	0.177
Angle collision	0.440	0.948	0.335	0.991	1.940
Sideswipe	0.121	0.261	0.044	0.130	0.391
Other multiple-vehicle collision	0.060	0.129	0.217	0.642	0.772

Worksheet 2E -- Single-Vehicle Collisions by Severity Level for Urban and Suburban Arterial Intersections															
(1)	(2)			(3)	(4)	(5)	(6)	(7)	(8)	(9)					
Crash Severity Level	SPF Coefficients			Overdispersion Parameter, k	Initial N_{bisv}	Proportion of Total Crashes	Adjusted N_{bisv}	Combined CMFs	Calibration Factor, C_i	Predicted N_{bisv}					
	from Table 12-12										from Table 12-12	from Eqn. 12-24; (FI) from Eqn. 12-24 or 12-27	$(4)_{TOTAL} * (5)$	(7) from Worksheet	$(6) * (7) * (8)$
	a	b	c												
Total	-5.33	0.33	0.12	0.65	0.409	1.000	0.409	0.97	1.00	0.396					
Fatal and Injury (FI)	--	--	--	--	0.114	$(4)_{FI} / ((4)_{FI} + (4)_{PDO})$ 0.250	0.102	0.97	1.00	0.099					
Property Damage Only (PDO)	-7.04	0.36	0.25	0.54	0.343	$(5)_{TOTAL} - (5)_{FI}$ 0.750	0.307	0.97	1.00	0.297					

Worksheet 2F -- Single-Vehicle Collisions by Collision Type for Urban and Suburban Arterial Intersections					
(1)	(2)	(3)	(4)	(5)	(6)
Collision Type	Proportion of Collision Type _(FI)	Predicted N _{bisv (FI)} (crashes/year)	Proportion of Collision Type (PDO)	Predicted N _{bisv (PDO)} (crashes/year)	Predicted N _{bisv (TOTAL)} (crashes/year)
	from Table 12-13	(9) _{FI} from Worksheet 2E	from Table 12-13	(9) _{PDO} from Worksheet 2E	(9) _{PDO} from Worksheet 2E
Total	1.000	0.099	1.000	0.297	0.396
		(2)*(3) _{FI}		(4)*(5) _{PDO}	(3)+(5)
Collision with parked vehicle	0.001	0.000	0.001	0.000	0.000
Collision with animal	0.001	0.000	0.026	0.008	0.008
Collision with fixed object	0.679	0.067	0.847	0.251	0.319
Collision with other object	0.089	0.009	0.070	0.021	0.030
Other single-vehicle collision	0.051	0.005	0.007	0.002	0.007
Single-vehicle noncollision	0.179	0.018	0.049	0.015	0.032

Worksheet 2G -- Vehicle-Pedestrian Collisions for Urban and Suburban Arterial Stop-Controlled Intersections						
(1)	(2)	(3)	(4)	(5)	(6)	(7)
Crash Severity Level	Predicted N _{bimv}	Predicted N _{bisv}	Predicted N _{bi}	f _{pedi}	Calibration factor, C _i	Predicted N _{pedi}
	(9) from Worksheet 2C	(9) from Worksheet 2E	(2) + (3)	from Table 12-16		(4)*(5)*(6)
Total	5.115	0.396	5.511	0.022	1.00	0.121
Fatal and injury (FI)	--	--	--	--	1.00	0.121

Worksheet 2H -- Crash Modification Factors for Vehicle-Pedestrian Collisions for Urban and Suburban Arterial Signalized Intersections			
(1)	(2)	(3)	(4)
CMF for Bus Stops	CMF for Schools	CMF for Alcohol Sales Establishments	Combined CMF
CMF _{1p}	CMF _{2p}	CMF _{3p}	
from Table 12-28	from Table 12-29	from Table 12-30	(1)*(2)*(3)
--	--	--	--

Worksheet 2I -- Vehicle-Pedestrian Collisions for Urban and Suburban Arterial Signalized Intersections										
(1)	(2)					(3)	(4)	(5)	(6)	(7)
Crash Severity Level	SPF Coefficients					Overdispersion Parameter, k	N _{pedbase}	Combined CMF	Calibration factor, C _i	Predicted N _{pedi}
	from Table 12-14									
	a	b	c	d	e					
Total	--	--	--	--	--	--	--	--	1.00	--
Fatal and Injury (FI)	--	--	--	--	--	--	--	--	1.00	--

Worksheet 2J -- Vehicle-Bicycle Collisions for Urban and Suburban Arterial Intersections						
(1)	(2)	(3)	(4)	(5)	(6)	(7)
Crash Severity Level	Predicted N_{bimv}	Predicted N_{bisv}	Predicted N_{bi}	f_{bikei}	Calibration factor, C_i	Predicted N_{bikei}
	(9) from Worksheet 2C	(9) from Worksheet 2E	(2) + (3)	from Table 12-17		(4)*(5)*(6)
Total	5.115	0.396	5.511	0.018	1.00	0.099
Fatal and injury (FI)	--	--	--	--	1.00	0.099

Worksheet 2K -- Crash Severity Distribution for Urban and Suburban Arterial Intersections			
(1)	(2)	(3)	(4)
Collision type	Fatal and injury (FI)	Property damage only (PDO)	Total
	(3) from Worksheet 2D and 2F; (7) from 2G or 2I and 2J	(5) from Worksheet 2D and 2F	(6) from Worksheet 2D and 2F; (7) from 2G or 2I and 2J
MULTIPLE-VEHICLE			
Rear-end collisions (from Worksheet 2D)	0.729	1.107	1.835
Head-on collisions (from Worksheet 2D)	0.088	0.089	0.177
Angle collisions (from Worksheet 2D)	0.948	0.991	1.940
Sideswipe (from Worksheet 2D)	0.261	0.130	0.391
Other multiple-vehicle collision (from Worksheet 2D)	0.129	0.642	0.772
Subtotal	2.155	2.960	5.115
SINGLE-VEHICLE			
Collision with parked vehicle (from Worksheet 2F)	0.000	0.000	0.000
Collision with animal (from Worksheet 2F)	0.000	0.008	0.008
Collision with fixed object (from Worksheet 2F)	0.067	0.251	0.319
Collision with other object (from Worksheet 2F)	0.009	0.021	0.030
Other single-vehicle collision (from Worksheet 2F)	0.005	0.002	0.007
Single-vehicle noncollision (from Worksheet 2F)	0.018	0.015	0.032
Collision with pedestrian (from Worksheet 2G or 2I)	0.121	0.000	0.121
Collision with bicycle (from Worksheet 2J)	0.099	0.000	0.099
Subtotal	0.320	0.297	0.616
Total	2.475	3.257	5.731

Worksheet 2L -- Summary Results for Urban and Suburban Arterial Intersections	
(1)	(2)
Crash severity level	Predicted average crash frequency, $N_{predicted\ int}$ (crashes/year)
	(Total) from Worksheet 2K
Total	5.7
Fatal and injury (FI)	2.5
Property damage only (PDO)	3.3

Worksheet 2A -- General Information and Input Data for Urban and Suburban Arterial Intersections						
General Information			Location Information			
Analyst	SZ		Intersection ID	2		
Agency or Company	Fehr & Peers		Intersection	Embarcadero/I-880 NB Off-Ramp		
Date Performed	12/26/18		Jurisdiction	Oakland, CA		
			Analysis Year	2018		
Input Data			Base Conditions	Site Conditions		
Intersection type (3ST, 3SG, 4ST, 4SG)			--	3ST		
AA _{major} (veh/day)	AA _{MAX} = 45,700 (veh/day)		--	21,120		
AA _{minor} (veh/day)	AA _{MAX} = 9,300 (veh/day)		--	4,440		
Intersection lighting (present/not present)			Not Present	Not Present		
Calibration factor, C _i			1.00	1.00		
Data for unsignalized intersections only:			--	--		
Number of major-road approaches with left-turn lanes (0,1,2)			0	0		
Number of major-road approaches with right-turn lanes (0,1,2)			0	0		
Data for signalized intersections only:			--	--		
Number of approaches with left-turn lanes (0,1,2,3,4) [for 3SG, use maximum value of 3]			0			
Number of approaches with right-turn lanes (0,1,2,3,4) [for 3SG, use maximum value of 3]			0			
Number of approaches with left-turn signal phasing [for 3SG, use maximum value of 3]			--			
Type of left-turn signal phasing for Leg #1			Permissive			
Type of left-turn signal phasing for Leg #2			--			
Type of left-turn signal phasing for Leg #3			--			
Type of left-turn signal phasing for Leg #4 (if applicable)			--			
Number of approaches with right-turn-on-red prohibited [for 3SG, use maximum value of 3]			0			
Intersection red light cameras (present/not present)			Not Present			
Sum of all pedestrian crossing volumes (PedVol) -- Signalized intersections only						
Maximum number of lanes crossed by a pedestrian (n _{lanesx})			--			
Number of bus stops within 300 m (1,000 ft) of the intersection			0			
Schools within 300 m (1,000 ft) of the intersection (present/not present)			Not Present			
Number of alcohol sales establishments within 300 m (1,000 ft) of the intersection			0			

Worksheet 2B -- Crash Modification Factors for Urban and Suburban Arterial Intersections						
(1)	(2)	(3)	(4)	(5)	(6)	(7)
CMF for Left-Turn Lanes	CMF for Left-Turn Signal Phasing	CMF for Right-Turn Lanes	CMF for Right Turn on Red	CMF for Lighting	CMF for Red Light Cameras	Combined CMF
CMF _{1i}	CMF _{2i}	CMF _{3i}	CMF _{4i}	CMF _{5i}	CMF _{6i}	CMF _{COMB}
from Table 12-24	from Table 12-25	from Table 12-26	from Equation 12-35	from Equation 12-36	from Equation 12-37	(1)*(2)*(3)*(4)*(5)*(6)
1.00	1.00	1.00	1.00	1.00	1.00	1.00

Worksheet 2C -- Multiple-Vehicle Collisions by Severity Level for Urban and Suburban Arterial Intersections

(1)	(2)			(3)	(4)	(5)	(6)	(7)	(8)	(9)					
Crash Severity Level	SPF Coefficients			Overdispersion Parameter, k	Initial N_{bimv}	Proportion of Total Crashes	Adjusted N_{bimv}	Combined CMFs	Calibration Factor, C_i	Predicted N_{bimv}					
	from Table 12-10										from Table 12-10	from Equation 12-21	(4) _{TOTAL} *(5)	(7) from Worksheet	(6)*(7)*(8)
	a	b	c												
Total	-13.36	1.11	0.41	0.80	3.116	1.000	3.116	1.00	1.00	3.126					
Fatal and Injury (FI)	-14.01	1.16	0.30	0.69	1.063	$(4)_{FI}/((4)_{FI}+(4)_{PDO})$ 0.312	0.972	1.00	1.00	0.975					
Property Damage Only (PDO)	-15.38	1.20	0.51	0.77	2.346	$(5)_{TOTAL}-(5)_{FI}$ 0.688	2.145	1.00	1.00	2.152					

Worksheet 2D -- Multiple-Vehicle Collisions by Collision Type for Urban and Suburban Arterial Intersections

(1)	(2)	(3)	(4)	(5)	(6)
Collision Type	Proportion of Collision Type _(FI)	Predicted $N_{bimv (FI)}$ (crashes/year)	Proportion of Collision Type _(PDO)	Predicted $N_{bimv (PDO)}$ (crashes/year)	Predicted $N_{bimv (TOTAL)}$ (crashes/year)
	from Table 12-11	(9) _{FI} from Worksheet 2C	from Table 12-11	(9) _{PDO} from Worksheet 2C	(9) _{PDO} from Worksheet 2C
Total	1.000	0.975	1.000	2.152	3.126
		$(2)*(3)_{FI}$		$(4)*(5)_{PDO}$	$(3)+(5)$
Rear-end collision	0.421	0.410	0.440	0.947	1.357
Head-on collision	0.045	0.044	0.023	0.049	0.093
Angle collision	0.343	0.334	0.262	0.564	0.898
Sideswipe	0.126	0.123	0.040	0.086	0.209
Other multiple-vehicle collision	0.065	0.063	0.235	0.506	0.569

Worksheet 2E -- Single-Vehicle Collisions by Severity Level for Urban and Suburban Arterial Intersections

(1)	(2)			(3)	(4)	(5)	(6)	(7)	(8)	(9)					
Crash Severity Level	SPF Coefficients			Overdispersion Parameter, k	Initial N_{bisv}	Proportion of Total Crashes	Adjusted N_{bisv}	Combined CMFs	Calibration Factor, C_i	Predicted N_{bisv}					
	from Table 12-12										from Table 12-12	from Eqn. 12-24; (FI) from Eqn. 12-24 or 12-27	(4) _{TOTAL} *(5)	(7) from Worksheet	(6)*(7)*(8)
	a	b	c												
Total	-6.81	0.16	0.51	1.14	0.393	1.000	0.393	1.00	1.00	0.394					
Fatal and Injury (FI)	--	--	--	--	0.122	$(4)_{FI}/((4)_{FI}+(4)_{PDO})$ 0.299	0.117	1.00	1.00	0.118					
Property Damage Only (PDO)	-8.36	0.25	0.55	1.29	0.286	$(5)_{TOTAL}-(5)_{FI}$ 0.701	0.276	1.00	1.00	0.277					

Worksheet 2F -- Single-Vehicle Collisions by Collision Type for Urban and Suburban Arterial Intersections					
(1)	(2)	(3)	(4)	(5)	(6)
Collision Type	Proportion of Collision Type _(FI)	Predicted N _{bisv (FI)} (crashes/year)	Proportion of Collision Type (PDO)	Predicted N _{bisv (PDO)} (crashes/year)	Predicted N _{bisv (TOTAL)} (crashes/year)
	from Table 12-13	(9) _{FI} from Worksheet 2E	from Table 12-13	(9) _{PDO} from Worksheet 2E	(9) _{PDO} from Worksheet 2E
Total	1.000	0.118	1.000	0.277	0.394
		(2)*(3) _{FI}		(4)*(5) _{PDO}	(3)+(5)
Collision with parked vehicle	0.001	0.000	0.003	0.001	0.001
Collision with animal	0.003	0.000	0.018	0.005	0.005
Collision with fixed object	0.762	0.090	0.834	0.231	0.320
Collision with other object	0.090	0.011	0.092	0.025	0.036
Other single-vehicle collision	0.039	0.005	0.023	0.006	0.011
Single-vehicle noncollision	0.105	0.012	0.030	0.008	0.021

Worksheet 2G -- Vehicle-Pedestrian Collisions for Urban and Suburban Arterial Stop-Controlled Intersections						
(1)	(2)	(3)	(4)	(5)	(6)	(7)
Crash Severity Level	Predicted N _{bimv}	Predicted N _{bisv}	Predicted N _{bi}	f _{pedi}	Calibration factor, C _i	Predicted N _{pedi}
	(9) from Worksheet 2C	(9) from Worksheet 2E	(2) + (3)	from Table 12-16		(4)*(5)*(6)
Total	3.126	0.394	3.520	0.021	1.00	0.074
Fatal and injury (FI)	--	--	--	--	1.00	0.074

Worksheet 2H -- Crash Modification Factors for Vehicle-Pedestrian Collisions for Urban and Suburban Arterial Signalized Intersections			
(1)	(2)	(3)	(4)
CMF for Bus Stops	CMF for Schools	CMF for Alcohol Sales Establishments	Combined CMF
CMF _{1p}	CMF _{2p}	CMF _{3p}	
from Table 12-28	from Table 12-29	from Table 12-30	(1)*(2)*(3)
--	--	--	--

Worksheet 2I -- Vehicle-Pedestrian Collisions for Urban and Suburban Arterial Signalized Intersections										
(1)	(2)					(3)	(4)	(5)	(6)	(7)
Crash Severity Level	SPF Coefficients					Overdispersion Parameter, k	N _{pedbase}	Combined CMF	Calibration factor, C _i	Predicted N _{pedi}
	from Table 12-14									
	a	b	c	d	e					
Total	--	--	--	--	--	--	--	--	1.00	--
Fatal and Injury (FI)	--	--	--	--	--	--	--	--	1.00	--

Worksheet 2J -- Vehicle-Bicycle Collisions for Urban and Suburban Arterial Intersections						
(1)	(2)	(3)	(4)	(5)	(6)	(7)
Crash Severity Level	Predicted N_{bimv}	Predicted N_{bisv}	Predicted N_{bi}	f_{bikei}	Calibration factor, C_i	Predicted N_{bikei}
	(9) from Worksheet 2C	(9) from Worksheet 2E	(2) + (3)	from Table 12-17		(4)*(5)*(6)
Total	3.126	0.394	3.520	0.016	1.00	0.056
Fatal and injury (FI)	--	--	--	--	1.00	0.056

Worksheet 2K -- Crash Severity Distribution for Urban and Suburban Arterial Intersections			
(1)	(2)	(3)	(4)
Collision type	Fatal and injury (FI)	Property damage only (PDO)	Total
	(3) from Worksheet 2D and 2F; (7) from 2G or 2I and 2J	(5) from Worksheet 2D and 2F	(6) from Worksheet 2D and 2F; (7) from 2G or 2I and 2J
MULTIPLE-VEHICLE			
Rear-end collisions (from Worksheet 2D)	0.410	0.947	1.357
Head-on collisions (from Worksheet 2D)	0.044	0.049	0.093
Angle collisions (from Worksheet 2D)	0.334	0.564	0.898
Sideswipe (from Worksheet 2D)	0.123	0.086	0.209
Other multiple-vehicle collision (from Worksheet 2D)	0.063	0.506	0.569
Subtotal	0.975	2.152	3.126
SINGLE-VEHICLE			
Collision with parked vehicle (from Worksheet 2F)	0.000	0.001	0.001
Collision with animal (from Worksheet 2F)	0.000	0.005	0.005
Collision with fixed object (from Worksheet 2F)	0.090	0.231	0.320
Collision with other object (from Worksheet 2F)	0.011	0.025	0.036
Other single-vehicle collision (from Worksheet 2F)	0.005	0.006	0.011
Single-vehicle noncollision (from Worksheet 2F)	0.012	0.008	0.021
Collision with pedestrian (from Worksheet 2G or 2I)	0.074	0.000	0.074
Collision with bicycle (from Worksheet 2J)	0.056	0.000	0.056
Subtotal	0.248	0.277	0.525
Total	1.223	2.428	3.651

Worksheet 2L -- Summary Results for Urban and Suburban Arterial Intersections	
(1)	(2)
Crash severity level	Predicted average crash frequency, $N_{predicted\ int}$ (crashes/year)
	(Total) from Worksheet 2K
Total	3.7
Fatal and injury (FI)	1.2
Property damage only (PDO)	2.4

Worksheet 2A -- General Information and Input Data for Urban and Suburban Arterial Intersections						
General Information			Location Information			
Analyst	SZ		Intersection ID	3		
Agency or Company	Fehr & Peers		Intersection	Embarcadero/10th Ave/I-880 SB On-Ramp		
Date Performed	12/26/18		Jurisdiction	Oakland, CA		
			Analysis Year	2018		
Input Data			Base Conditions	Site Conditions		
Intersection type (3ST, 3SG, 4ST, 4SG)			--	4ST		
AA _{major} (veh/day)	AA _{MAX} = 46,800 (veh/day)		--	18,120		
AA _{minor} (veh/day)	AA _{MAX} = 5,900 (veh/day)		--	8,300		
Intersection lighting (present/not present)			Not Present	Not Present		
Calibration factor, C _i			1.00	1.00		
Data for unsignalized intersections only:			--	--		
Number of major-road approaches with left-turn lanes (0,1,2)			0	1		
Number of major-road approaches with right-turn lanes (0,1,2)			0	1		
Data for signalized intersections only:			--	--		
Number of approaches with left-turn lanes (0,1,2,3,4) [for 3SG, use maximum value of 3]			0			
Number of approaches with right-turn lanes (0,1,2,3,4) [for 3SG, use maximum value of 3]			0			
Number of approaches with left-turn signal phasing [for 3SG, use maximum value of 3]			--			
Type of left-turn signal phasing for Leg #1			Permissive			
Type of left-turn signal phasing for Leg #2			--			
Type of left-turn signal phasing for Leg #3			--			
Type of left-turn signal phasing for Leg #4 (if applicable)			--			
Number of approaches with right-turn-on-red prohibited [for 3SG, use maximum value of 3]			0			
Intersection red light cameras (present/not present)			Not Present			
Sum of all pedestrian crossing volumes (PedVol) -- Signalized intersections only						
Maximum number of lanes crossed by a pedestrian (n _{lanesx})			--			
Number of bus stops within 300 m (1,000 ft) of the intersection			0			
Schools within 300 m (1,000 ft) of the intersection (present/not present)			Not Present			
Number of alcohol sales establishments within 300 m (1,000 ft) of the intersection			0			

Worksheet 2B -- Crash Modification Factors for Urban and Suburban Arterial Intersections						
(1)	(2)	(3)	(4)	(5)	(6)	(7)
CMF for Left-Turn Lanes	CMF for Left-Turn Signal Phasing	CMF for Right-Turn Lanes	CMF for Right Turn on Red	CMF for Lighting	CMF for Red Light Cameras	Combined CMF
CMF _{1i}	CMF _{2i}	CMF _{3i}	CMF _{4i}	CMF _{5i}	CMF _{6i}	CMF _{COMB}
from Table 12-24	from Table 12-25	from Table 12-26	from Equation 12-35	from Equation 12-36	from Equation 12-37	(1)*(2)*(3)*(4)*(5)*(6)
0.73	1.00	0.86	1.00	1.00	0.97	0.61

Worksheet 2C -- Multiple-Vehicle Collisions by Severity Level for Urban and Suburban Arterial Intersections

(1)	(2)			(3)	(4)	(5)	(6)	(7)	(8)	(9)				
Crash Severity Level	SPF Coefficients			Overdispersion Parameter, k	Initial N_{bimv}	Proportion of Total Crashes	Adjusted N_{bimv}	Combined CMFs	Calibration Factor, C_i	Predicted N_{bimv}				
	from Table 12-10										from Equation 12-21	$(4)_{TOTAL} * (5)$	(7) from Worksheet	$(6) * (7) * (8)$
	a	b	c								from Table 12-10			
Total	-8.90	0.82	0.25	0.40	4.039	1.000	4.039	0.61	1.00	2.457				
Fatal and Injury (FI)	-11.13	0.93	0.28	0.48	1.674	$(4)_{FI} / ((4)_{FI} + (4)_{PDO})$ 0.409	1.650	0.61	1.00	1.004				
Property Damage Only (PDO)	-8.74	0.77	0.23	0.40	2.423	$(5)_{TOTAL} - (5)_{FI}$ 0.591	2.389	0.61	1.00	1.453				

Worksheet 2D -- Multiple-Vehicle Collisions by Collision Type for Urban and Suburban Arterial Intersections

(1)	(2)	(3)	(4)	(5)	(6)
Collision Type	Proportion of Collision Type _(FI)	Predicted $N_{bimv (FI)}$ (crashes/year)	Proportion of Collision Type _(PDO)	Predicted $N_{bimv (PDO)}$ (crashes/year)	Predicted $N_{bimv (TOTAL)}$ (crashes/year)
	from Table 12-11	$(9)_{FI}$ from Worksheet 2C	from Table 12-11	$(9)_{PDO}$ from Worksheet 2C	$(9)_{PDO}$ from Worksheet 2C
Total	1.000	1.004	1.000	1.453	2.457
		$(2) * (3)_{FI}$		$(4) * (5)_{PDO}$	$(3) + (5)$
Rear-end collision	0.338	0.339	0.374	0.544	0.883
Head-on collision	0.041	0.041	0.030	0.044	0.085
Angle collision	0.440	0.442	0.335	0.487	0.929
Sideswipe	0.121	0.121	0.044	0.064	0.185
Other multiple-vehicle collision	0.060	0.060	0.217	0.315	0.376

Worksheet 2E -- Single-Vehicle Collisions by Severity Level for Urban and Suburban Arterial Intersections

(1)	(2)			(3)	(4)	(5)	(6)	(7)	(8)	(9)				
Crash Severity Level	SPF Coefficients			Overdispersion Parameter, k	Initial N_{bisv}	Proportion of Total Crashes	Adjusted N_{bisv}	Combined CMFs	Calibration Factor, C_i	Predicted N_{bisv}				
	from Table 12-12										from Eqn. 12-24; (FI) from Eqn. 12-24 or 12-27	$(4)_{TOTAL} * (5)$	(7) from Worksheet	$(6) * (7) * (8)$
	a	b	c								from Table 12-12			
Total	-5.33	0.33	0.12	0.65	0.364	1.000	0.364	0.61	1.00	0.221				
Fatal and Injury (FI)	--	--	--	--	0.102	$(4)_{FI} / ((4)_{FI} + (4)_{PDO})$ 0.263	0.096	0.61	1.00	0.058				
Property Damage Only (PDO)	-7.04	0.36	0.25	0.54	0.285	$(5)_{TOTAL} - (5)_{FI}$ 0.737	0.268	0.61	1.00	0.163				

Worksheet 2F -- Single-Vehicle Collisions by Collision Type for Urban and Suburban Arterial Intersections					
(1)	(2)	(3)	(4)	(5)	(6)
Collision Type	Proportion of Collision Type _(FI)	Predicted N _{bisv (FI)} (crashes/year)	Proportion of Collision Type (PDO)	Predicted N _{bisv (PDO)} (crashes/year)	Predicted N _{bisv (TOTAL)} (crashes/year)
	from Table 12-13	(9) _{FI} from Worksheet 2E	from Table 12-13	(9) _{PDO} from Worksheet 2E	(9) _{PDO} from Worksheet 2E
Total	1.000	0.058	1.000	0.163	0.221
		(2)*(3) _{FI}		(4)*(5) _{PDO}	(3)+(5)
Collision with parked vehicle	0.001	0.000	0.001	0.000	0.000
Collision with animal	0.001	0.000	0.026	0.004	0.004
Collision with fixed object	0.679	0.040	0.847	0.138	0.178
Collision with other object	0.089	0.005	0.070	0.011	0.017
Other single-vehicle collision	0.051	0.003	0.007	0.001	0.004
Single-vehicle noncollision	0.179	0.010	0.049	0.008	0.018

Worksheet 2G -- Vehicle-Pedestrian Collisions for Urban and Suburban Arterial Stop-Controlled Intersections						
(1)	(2)	(3)	(4)	(5)	(6)	(7)
Crash Severity Level	Predicted N _{bimv}	Predicted N _{bisv}	Predicted N _{bi}	f _{pedi}	Calibration factor, C _i	Predicted N _{pedi}
	(9) from Worksheet 2C	(9) from Worksheet 2E	(2) + (3)	from Table 12-16		(4)*(5)*(6)
Total	2.457	0.221	2.679	0.022	1.00	0.059
Fatal and injury (FI)	--	--	--	--	1.00	0.059

Worksheet 2H -- Crash Modification Factors for Vehicle-Pedestrian Collisions for Urban and Suburban Arterial Signalized Intersections			
(1)	(2)	(3)	(4)
CMF for Bus Stops	CMF for Schools	CMF for Alcohol Sales Establishments	Combined CMF
CMF _{1p}	CMF _{2p}	CMF _{3p}	
from Table 12-28	from Table 12-29	from Table 12-30	(1)*(2)*(3)
--	--	--	--

Worksheet 2I -- Vehicle-Pedestrian Collisions for Urban and Suburban Arterial Signalized Intersections										
(1)	(2)					(3)	(4)	(5)	(6)	(7)
Crash Severity Level	SPF Coefficients					Overdispersion Parameter, k	N _{pedbase}	Combined CMF	Calibration factor, C _i	Predicted N _{pedi}
	from Table 12-14									
	a	b	c	d	e					
Total	--	--	--	--	--	--	--	--	1.00	--
Fatal and Injury (FI)	--	--	--	--	--	--	--	--	1.00	--

Worksheet 2J -- Vehicle-Bicycle Collisions for Urban and Suburban Arterial Intersections						
(1)	(2)	(3)	(4)	(5)	(6)	(7)
Crash Severity Level	Predicted N_{bimv}	Predicted N_{bisv}	Predicted N_{bi}	f_{bikei}	Calibration factor, C_i	Predicted N_{bikei}
	(9) from Worksheet 2C	(9) from Worksheet 2E	(2) + (3)	from Table 12-17		(4)*(5)*(6)
Total	2.457	0.221	2.679	0.018	1.00	0.048
Fatal and injury (FI)	--	--	--	--	1.00	0.048

Worksheet 2K -- Crash Severity Distribution for Urban and Suburban Arterial Intersections			
(1)	(2)	(3)	(4)
Collision type	Fatal and injury (FI)	Property damage only (PDO)	Total
	(3) from Worksheet 2D and 2F; (7) from 2G or 2I and 2J	(5) from Worksheet 2D and 2F	(6) from Worksheet 2D and 2F; (7) from 2G or 2I and 2J
MULTIPLE-VEHICLE			
Rear-end collisions (from Worksheet 2D)	0.339	0.544	0.883
Head-on collisions (from Worksheet 2D)	0.041	0.044	0.085
Angle collisions (from Worksheet 2D)	0.442	0.487	0.929
Sideswipe (from Worksheet 2D)	0.121	0.064	0.185
Other multiple-vehicle collision (from Worksheet 2D)	0.060	0.315	0.376
Subtotal	1.004	1.453	2.457
SINGLE-VEHICLE			
Collision with parked vehicle (from Worksheet 2F)	0.000	0.000	0.000
Collision with animal (from Worksheet 2F)	0.000	0.004	0.004
Collision with fixed object (from Worksheet 2F)	0.040	0.138	0.178
Collision with other object (from Worksheet 2F)	0.005	0.011	0.017
Other single-vehicle collision (from Worksheet 2F)	0.003	0.001	0.004
Single-vehicle noncollision (from Worksheet 2F)	0.010	0.008	0.018
Collision with pedestrian (from Worksheet 2G or 2I)	0.059	0.000	0.059
Collision with bicycle (from Worksheet 2J)	0.048	0.000	0.048
Subtotal	0.165	0.163	0.328
Total	1.169	1.617	2.786

Worksheet 2L -- Summary Results for Urban and Suburban Arterial Intersections	
(1)	(2)
Crash severity level	Predicted average crash frequency, $N_{predicted\ int}$ (crashes/year)
	(Total) from Worksheet 2K
Total	2.8
Fatal and injury (FI)	1.2
Property damage only (PDO)	1.6

Worksheet 1A -- General Information and Input Data for Urban and Suburban Roadway Segments					
General Information			Location Information		
Analyst	SZ		Roadway	Embarcadero	
Agency or Company	Fehr & Peers		Roadway Section	4th Ave to 5th Ave	
Date Performed	12/26/18		Jurisdiction	Oakland, CA	
			Analysis Year	2018	
Input Data			Base Conditions	Site Conditions	
Roadway type (2U, 3T, 4U, 4D, ST)			--	2U	
Length of segment, L (mi)			--	0.11	
AADT (veh/day)	AADT _{MAX} = 32,600 (veh/day)		--	21,120	
Type of on-street parking (none/parallel/angle)			None	None	
Proportion of curb length with on-street parking			--	0	
Median width (ft) - for divided only			15	Not Present	
Lighting (present / not present)			Not Present	Present	
Auto speed enforcement (present / not present)			Not Present	Not Present	
Major commercial driveways (number)			--	0	
Minor commercial driveways (number)			--	0	
Major industrial / institutional driveways (number)			--	0	
Minor industrial / institutional driveways (number)			--	0	
Major residential driveways (number)			--	0	
Minor residential driveways (number)			--	0	
Other driveways (number)			--	0	
Speed Category			--	Posted Speed 30 mph or Lower	
Roadside fixed object density (fixed objects / mi)			0	63.6	
Offset to roadside fixed objects (ft) [If greater than 30 or Not Present, input 30]			30	30	
Calibration Factor, Cr			1.00	1.00	

Worksheet 1B -- Crash Modification Factors for Urban and Suburban Roadway Segments					
(1)	(2)	(3)	(4)	(5)	(6)
CMF for On-Street Parking	CMF for Roadside Fixed Objects	CMF for Median Width	CMF for Lighting	CMF for Automated Speed Enforcement	Combined CMF
<i>CMF 1r</i>	<i>CMF 2r</i>	<i>CMF 3r</i>	<i>CMF 4r</i>	<i>CMF 5r</i>	<i>CMF comb</i>
from Equation 12-32	from Equation 12-33	from Table 12-22	from Equation 12-34	from Section 12.7.1	(1)*(2)*(3)*(4)*(5)
1.00	1.11	1.00	0.93	1.00	1.03

Worksheet 1C -- Multiple-Vehicle Nondriveway Collisions by Severity Level for Urban and Suburban Roadway Segments									
(1)	(2)		(3)	(4)	(5)	(6)	(7)	(8)	(9)
Crash Severity Level	SPF Coefficients		Overdispersion Parameter, k	Initial N _{brmv}	Proportion of Total Crashes	Adjusted N _{brmv}	Combined CMFs	Calibration Factor, Cr	Predicted N _{brmv}
	a	b							
Total	-15.22	1.68	0.84	0.498	1.000	0.498	1.03	1.00	0.513
Fatal and Injury (FI)	-16.22	1.66	0.65	0.150	$(4)_{FI} / ((4)_{FI} + (4)_{PDO})$ 0.289	0.144	1.03	1.00	0.148
Property Damage Only (PDO)	-15.62	1.69	0.87	0.369	$(5)_{TOTAL} - (5)_{FI}$ 0.711	0.354	1.03	1.00	0.365

Worksheet 1D -- Multiple-Vehicle Nondriveway Collisions by Collision Type for Urban and Suburban Roadway Segments					
(1) Collision Type	(2) Proportion of Collision Type _(FI)	(3) Predicted N _{brmv (FI)} (crashes/year)	(4) Proportion of Collision Type _(PDO)	(5) Predicted N _{brmv (PDO)} (crashes/year)	(6) Predicted N _{brmv (TOTAL)} (crashes/year)
	from Table 12-4	(9) _{FI} from Worksheet 1C	from Table 12-4	(9) _{PDO} from Worksheet 1C	(9) _{TOTAL} from Worksheet 1C
Total	1.000	0.148	1.000	0.365	0.513
		(2)*(3) _{FI}		(4)*(5) _{PDO}	(3)+(5)
Rear-end collision	0.730	0.108	0.778	0.284	0.392
Head-on collision	0.068	0.010	0.004	0.001	0.012
Angle collision	0.085	0.013	0.079	0.029	0.041
Sideswipe, same direction	0.015	0.002	0.031	0.011	0.014
Sideswipe, opposite direction	0.073	0.011	0.055	0.020	0.031
Other multiple-vehicle collision	0.029	0.004	0.053	0.019	0.024

Worksheet 1E -- Single-Vehicle Collisions by Severity Level for Urban and Suburban Roadway Segments									
(1) Crash Severity Level	(2) SPF Coefficients		(3) Overdispersion Parameter, k	(4) Initial N _{brsv}	(5) Proportion of Total Crashes	(6) Adjusted N _{brsv}	(7) Combined CMFs	(8) Calibration Factor, Cr	(9) Predicted N _{brsv}
	from Table 12-5		from Table 12-5	from Equation 12-13		(4) _{TOTAL} *(5)	(6) from Worksheet		(6)*(7)*(8)
	a	b							
Total	-5.47	0.56	0.81	0.122	1.000	0.122	1.03	1.00	0.126
Fatal and Injury (FI)	-3.96	0.23	0.50	0.021	(4) _{FI} /((4) _{FI} +(4) _{PDO}) 0.178	0.022	1.03	1.00	0.022
Property Damage Only (PDO)	-6.51	0.64	0.87	0.096	(5) _{TOTAL} -(5) _{FI} 0.822	0.101	1.03	1.00	0.104

Worksheet 1F -- Single-Vehicle Collisions by Collision Type for Urban and Suburban Roadway Segments					
(1) Collision Type	(2) Proportion of Collision Type _(FI)	(3) Predicted N _{brsv (FI)} (crashes/year)	(4) Proportion of Collision Type _(PDO)	(5) Predicted N _{brsv (PDO)} (crashes/year)	(6) Predicted N _{brsv (TOTAL)} (crashes/year)
	from Table 12-6	(9) _{FI} from Worksheet 1E	from Table 12-6	(9) _{PDO} from Worksheet 1E	(9) _{TOTAL} from Worksheet 1E
Total	1.000	0.022	1.000	0.104	0.126
		(2)*(3) _{FI}		(4)*(5) _{PDO}	(3)+(5)
Collision with animal	0.026	0.001	0.066	0.007	0.007
Collision with fixed object	0.723	0.016	0.759	0.079	0.095
Collision with other object	0.010	0.000	0.013	0.001	0.002
Other single-vehicle collision	0.241	0.005	0.162	0.017	0.022

Worksheet 1G -- Multiple-Vehicle Driveway-Related Collisions by Driveway Type for Urban and Suburban Roadway Segments					
(1)	(2)	(3)	(4)	(5)	(6)
Driveway Type	Number of driveways, n_j	Crashes per driveway per year, N_j	Coefficient for traffic adjustment, t	Initial N_{brdwy}	Overdispersion parameter, k
		from Table 12-7	from Table 12-7	Equation 12-16 $n_j * N_j * (AADT/15,000)^t$	from Table 12-7
Major commercial	0	0.158	1.000	0.000	--
Minor commercial	0	0.050	1.000	0.000	
Major industrial/institutional	0	0.172	1.000	0.000	
Minor industrial/institutional	0	0.023	1.000	0.000	
Major residential	0	0.083	1.000	0.000	
Minor residential	0	0.016	1.000	0.000	
Other	0	0.025	1.000	0.000	
Total	--	--	--	0.000	0.81

Worksheet 1H -- Multiple-Vehicle Driveway-Related Collisions by Severity Level for Urban and Suburban Roadway Segments						
(1)	(2)	(3)	(4)	(5)	(6)	(7)
Crash Severity Level	Initial N_{brdwy}	Proportion of total crashes (f_{dwy})	Adjusted N_{brdwy}	Combined CMFs	Calibration factor, C_r	Predicted N_{brdwy}
	(5) _{TOTAL} from Worksheet 1G	from Table 12-7	(2) _{TOTAL} * (3)	(6) from Worksheet 1B		(4)*(5)*(6)
Total	0.000	1.000	0.000	1.03	1.00	0.000
Fatal and injury (FI)	--	0.323	0.000	1.03	1.00	0.000
Property damage only (PDO)	--	0.677	0.000	1.03	1.00	0.000

Worksheet 1I -- Vehicle-Pedestrian Collisions for Urban and Suburban Roadway Segments							
(1)	(2)	(3)	(4)	(5)	(6)	(7)	(8)
Crash Severity Level	Predicted N_{brmv}	Predicted N_{brsv}	Predicted N_{brdwy}	Predicted N_{br}	f_{pedr}	Calibration factor, C_r	Predicted N_{pedr}
	(9) from Worksheet 1C	(9) from Worksheet 1E	(7) from Worksheet 1H	(2)+(3)+(4)	from Table 12-8		(5)*(6)*(7)
Total	0.513	0.126	0.000	0.639	0.036	1.00	0.023
Fatal and injury (FI)	--	--	--	--	--	1.00	0.023

Worksheet 1J -- Vehicle-Bicycle Collisions for Urban and Suburban Roadway Segments							
(1)	(2)	(3)	(4)	(5)	(6)	(7)	(8)
Crash Severity Level	Predicted N_{brmv}	Predicted N_{brsv}	Predicted N_{brdwy}	Predicted N_{br}	f_{biker}	Calibration factor, C_r	Predicted N_{biker}
	(9) from Worksheet 1C	(9) from Worksheet 1E	(7) from Worksheet 1H	(2)+(3)+(4)	from Table 12-9		(5)*(6)*(7)
Total	0.513	0.126	0.000	0.639	0.018	1.00	0.012
Fatal and injury (FI)	--	--	--	--	--	1.00	0.012

Worksheet 1A -- General Information and Input Data for Urban and Suburban Roadway Segments					
General Information			Location Information		
Analyst	SZ		Roadway	Embarcadero	
Agency or Company	Fehr & Peers		Roadway Section	5th Ave to 6th Ave/Brooklyn Basin Way	
Date Performed	12/26/18		Jurisdiction	Oakland, CA	
			Analysis Year	2018	
Input Data			Base Conditions	Site Conditions	
Roadway type (2U, 3T, 4U, 4D, ST)			--	2U	
Length of segment, L (mi)			--	0.096	
AADT (veh/day)	AADT _{MAX} = 32,600 (veh/day)		--	21,120	
Type of on-street parking (none/parallel/angle)			None	None	
Proportion of curb length with on-street parking			--	0	
Median width (ft) - for divided only			15	Not Present	
Lighting (present / not present)			Not Present	Present	
Auto speed enforcement (present / not present)			Not Present	Not Present	
Major commercial driveways (number)			--	0	
Minor commercial driveways (number)			--	0	
Major industrial / institutional driveways (number)			--	0	
Minor industrial / institutional driveways (number)			--	1	
Major residential driveways (number)			--	0	
Minor residential driveways (number)			--	0	
Other driveways (number)			--	0	
Speed Category			--	Posted Speed 30 mph or Lower	
Roadside fixed object density (fixed objects / mi)			0	62.5	
Offset to roadside fixed objects (ft) [If greater than 30 or Not Present, input 30]			30	30	
Calibration Factor, Cr			1.00	1.00	

Worksheet 1B -- Crash Modification Factors for Urban and Suburban Roadway Segments					
(1)	(2)	(3)	(4)	(5)	(6)
CMF for On-Street Parking	CMF for Roadside Fixed Objects	CMF for Median Width	CMF for Lighting	CMF for Automated Speed Enforcement	Combined CMF
<i>CMF 1r</i>	<i>CMF 2r</i>	<i>CMF 3r</i>	<i>CMF 4r</i>	<i>CMF 5r</i>	<i>CMF comb</i>
from Equation 12-32	from Equation 12-33	from Table 12-22	from Equation 12-34	from Section 12.7.1	(1)*(2)*(3)*(4)*(5)
1.00	1.10	1.00	0.93	1.00	1.03

Worksheet 1C -- Multiple-Vehicle Nondriveway Collisions by Severity Level for Urban and Suburban Roadway Segments									
(1)	(2)		(3)	(4)	(5)	(6)	(7)	(8)	(9)
Crash Severity Level	SPF Coefficients		Overdispersion Parameter, k	Initial N _{brmv}	Proportion of Total Crashes	Adjusted N _{brmv}	Combined CMFs	Calibration Factor, Cr	Predicted N _{brmv}
	a	b							
Total	-15.22	1.68	0.84	0.434	1.000	0.434	1.03	1.00	0.447
Fatal and Injury (FI)	-16.22	1.66	0.65	0.131	$(4)_{FI} / ((4)_{FI} + (4)_{PDO})$ 0.289	0.126	1.03	1.00	0.129
Property Damage Only (PDO)	-15.62	1.69	0.87	0.322	$(5)_{TOTAL} - (5)_{FI}$ 0.711	0.309	1.03	1.00	0.317

Worksheet 1D -- Multiple-Vehicle Nondriveway Collisions by Collision Type for Urban and Suburban Roadway Segments					
(1) Collision Type	(2) Proportion of Collision Type _(FI)	(3) Predicted N _{brmv (FI)} (crashes/year)	(4) Proportion of Collision Type _(PDO)	(5) Predicted N _{brmv (PDO)} (crashes/year)	(6) Predicted N _{brmv (TOTAL)} (crashes/year)
	from Table 12-4	(9) _{FI} from Worksheet 1C	from Table 12-4	(9) _{PDO} from Worksheet 1C	(9) _{TOTAL} from Worksheet 1C
Total	1.000	0.129	1.000	0.317	0.447
		(2)*(3) _{FI}		(4)*(5) _{PDO}	(3)+(5)
Rear-end collision	0.730	0.094	0.778	0.247	0.341
Head-on collision	0.068	0.009	0.004	0.001	0.010
Angle collision	0.085	0.011	0.079	0.025	0.036
Sideswipe, same direction	0.015	0.002	0.031	0.010	0.012
Sideswipe, opposite direction	0.073	0.009	0.055	0.017	0.027
Other multiple-vehicle collision	0.029	0.004	0.053	0.017	0.021

Worksheet 1E -- Single-Vehicle Collisions by Severity Level for Urban and Suburban Roadway Segments									
(1) Crash Severity Level	(2) SPF Coefficients		(3) Overdispersion Parameter, k	(4) Initial N _{brsv}	(5) Proportion of Total Crashes	(6) Adjusted N _{brsv}	(7) Combined CMFs	(8) Calibration Factor, Cr	(9) Predicted N _{brsv}
	from Table 12-5		from Table 12-5	from Equation 12-13		(4) _{TOTAL} *(5)	(6) from Worksheet		(6)*(7)*(8)
	a	b							
Total	-5.47	0.56	0.81	0.107	1.000	0.107	1.03	1.00	0.110
Fatal and Injury (FI)	-3.96	0.23	0.50	0.018	(4) _{FI} /((4) _{FI} +(4) _{PDO}) 0.178	0.019	1.03	1.00	0.020
Property Damage Only (PDO)	-6.51	0.64	0.87	0.084	(5) _{TOTAL} -(5) _{FI} 0.822	0.088	1.03	1.00	0.090

Worksheet 1F -- Single-Vehicle Collisions by Collision Type for Urban and Suburban Roadway Segments					
(1) Collision Type	(2) Proportion of Collision Type _(FI)	(3) Predicted N _{brsv (FI)} (crashes/year)	(4) Proportion of Collision Type _(PDO)	(5) Predicted N _{brsv (PDO)} (crashes/year)	(6) Predicted N _{brsv (TOTAL)} (crashes/year)
	from Table 12-6	(9) _{FI} from Worksheet 1E	from Table 12-6	(9) _{PDO} from Worksheet 1E	(9) _{TOTAL} from Worksheet 1E
Total	1.000	0.020	1.000	0.090	0.110
		(2)*(3) _{FI}		(4)*(5) _{PDO}	(3)+(5)
Collision with animal	0.026	0.001	0.066	0.006	0.006
Collision with fixed object	0.723	0.014	0.759	0.069	0.083
Collision with other object	0.010	0.000	0.013	0.001	0.001
Other single-vehicle collision	0.241	0.005	0.162	0.015	0.019

Worksheet 1G -- Multiple-Vehicle Driveway-Related Collisions by Driveway Type for Urban and Suburban Roadway Segments					
(1)	(2)	(3)	(4)	(5)	(6)
Driveway Type	Number of driveways, n_j	Crashes per driveway per year, N_j	Coefficient for traffic adjustment, t	Initial N_{brdwy}	Overdispersion parameter, k
		from Table 12-7	from Table 12-7	Equation 12-16 $n_j * N_j * (AADT/15,000)^t$	from Table 12-7
Major commercial	0	0.158	1.000	0.000	--
Minor commercial	0	0.050	1.000	0.000	
Major industrial/institutional	0	0.172	1.000	0.000	
Minor industrial/institutional	1	0.023	1.000	0.032	
Major residential	0	0.083	1.000	0.000	
Minor residential	0	0.016	1.000	0.000	
Other	0	0.025	1.000	0.000	
Total	--	--	--	0.032	0.81

Worksheet 1H -- Multiple-Vehicle Driveway-Related Collisions by Severity Level for Urban and Suburban Roadway Segments						
(1)	(2)	(3)	(4)	(5)	(6)	(7)
Crash Severity Level	Initial N_{brdwy}	Proportion of total crashes (f_{dwy})	Adjusted N_{brdwy}	Combined CMFs	Calibration factor, C_r	Predicted N_{brdwy}
	(5) _{TOTAL} from Worksheet 1G	from Table 12-7	(2) _{TOTAL} * (3)	(6) from Worksheet 1B		(4)*(5)*(6)
Total	0.032	1.000	0.032	1.03	1.00	0.033
Fatal and injury (FI)	--	0.323	0.010	1.03	1.00	0.011
Property damage only (PDO)	--	0.677	0.022	1.03	1.00	0.023

Worksheet 1I -- Vehicle-Pedestrian Collisions for Urban and Suburban Roadway Segments							
(1)	(2)	(3)	(4)	(5)	(6)	(7)	(8)
Crash Severity Level	Predicted N_{brmv}	Predicted N_{brsv}	Predicted N_{brdwy}	Predicted N_{br}	f_{pedr}	Calibration factor, C_r	Predicted N_{pedr}
	(9) from Worksheet 1C	(9) from Worksheet 1E	(7) from Worksheet 1H	(2)+(3)+(4)	from Table 12-8		(5)*(6)*(7)
Total	0.447	0.110	0.033	0.590	0.036	1.00	0.021
Fatal and injury (FI)	--	--	--	--	--	1.00	0.021

Worksheet 1J -- Vehicle-Bicycle Collisions for Urban and Suburban Roadway Segments							
(1)	(2)	(3)	(4)	(5)	(6)	(7)	(8)
Crash Severity Level	Predicted N_{brmv}	Predicted N_{brsv}	Predicted N_{brdwy}	Predicted N_{br}	f_{biker}	Calibration factor, C_r	Predicted N_{biker}
	(9) from Worksheet 1C	(9) from Worksheet 1E	(7) from Worksheet 1H	(2)+(3)+(4)	from Table 12-9		(5)*(6)*(7)
Total	0.447	0.110	0.033	0.590	0.018	1.00	0.011
Fatal and injury (FI)	--	--	--	--	--	1.00	0.011

Worksheet 1K -- Crash Severity Distribution for Urban and Suburban Roadway Segments			
(1)	(2)	(3)	(4)
Collision type	Fatal and injury (FI)	Property damage only (PDO)	Total
	(3) from Worksheet 1D and 1F; (7) from Worksheet 1H; and (8) from Worksheet 1I and 1J	(5) from Worksheet 1D and 1F; and (7) from Worksheet 1H	(6) from Worksheet 1D and 1F; (7) from Worksheet 1H; and (8) from Worksheet 1I and 1J
MULTIPLE-VEHICLE			
Rear-end collisions (from Worksheet 1D)	0.094	0.247	0.341
Head-on collisions (from Worksheet 1D)	0.009	0.001	0.010
Angle collisions (from Worksheet 1D)	0.011	0.025	0.036
Sideswipe, same direction (from Worksheet 1D)	0.002	0.010	0.012
Sideswipe, opposite direction (from Worksheet 1D)	0.009	0.017	0.027
Driveway-related collisions (from Worksheet 1H)	0.011	0.023	0.033
Other multiple-vehicle collision (from Worksheet 1D)	0.004	0.017	0.021
Subtotal	0.140	0.340	0.480
SINGLE-VEHICLE			
Collision with animal (from Worksheet 1F)	0.001	0.006	0.006
Collision with fixed object (from Worksheet 1F)	0.014	0.069	0.083
Collision with other object (from Worksheet 1F)	0.000	0.001	0.001
Other single-vehicle collision (from Worksheet 1F)	0.005	0.015	0.019
Collision with pedestrian (from Worksheet 1I)	0.021	0.000	0.021
Collision with bicycle (from Worksheet 1J)	0.011	0.000	0.011
Subtotal	0.051	0.090	0.142
Total	0.191	0.430	0.622

Worksheet 1L -- Summary Results for Urban and Suburban Roadway Segments			
(1)	(2)	(3)	(4)
Crash Severity Level	Predicted average crash frequency, N_{predicted rs} (crashes/year)	Roadway segment length, L (mi)	Crash rate (crashes/mi/year)
	(Total) from Worksheet 1K		(2) / (3)
Total	0.6	0.10	6.5
Fatal and injury (FI)	0.2	0.10	2.0
Property damage only (PDO)	0.4	0.10	4.5

Worksheet 1A -- General Information and Input Data for Urban and Suburban Roadway Segments			
General Information		Location Information	
Analyst	SZ	Roadway	Embarcadero
Agency or Company	Fehr & Peers	Roadway Section	6th Ave/Brooklyn Basin Way to 8th Ave
Date Performed	12/26/18	Jurisdiction	Oakland, CA
		Analysis Year	2018
Input Data		Base Conditions	Site Conditions
Roadway type (2U, 3T, 4U, 4D, ST)		--	2U
Length of segment, L (mi)		--	0.169
AADT (veh/day)	AADT _{MAX} = 32,600 (veh/day)	--	18,120
Type of on-street parking (none/parallel/angle)		None	None
Proportion of curb length with on-street parking		--	0
Median width (ft) - for divided only		15	Not Present
Lighting (present / not present)		Not Present	Present
Auto speed enforcement (present / not present)		Not Present	Not Present
Major commercial driveways (number)		--	0
Minor commercial driveways (number)		--	0
Major industrial / institutional driveways (number)		--	0
Minor industrial / institutional driveways (number)		--	0
Major residential driveways (number)		--	0
Minor residential driveways (number)		--	0
Other driveways (number)		--	0
Speed Category		--	Posted Speed 30 mph or Lower
Roadside fixed object density (fixed objects / mi)		0	29.6
Offset to roadside fixed objects (ft) [If greater than 30 or Not Present, input 30]		30	30
Calibration Factor, Cr		1.00	1.00

Worksheet 1B -- Crash Modification Factors for Urban and Suburban Roadway Segments					
(1)	(2)	(3)	(4)	(5)	(6)
CMF for On-Street Parking	CMF for Roadside Fixed Objects	CMF for Median Width	CMF for Lighting	CMF for Automated Speed Enforcement	Combined CMF
<i>CMF 1r</i>	<i>CMF 2r</i>	<i>CMF 3r</i>	<i>CMF 4r</i>	<i>CMF 5r</i>	<i>CMF comb</i>
from Equation 12-32	from Equation 12-33	from Table 12-22	from Equation 12-34	from Section 12.7.1	(1)*(2)*(3)*(4)*(5)
1.00	1.02	1.00	0.93	1.00	0.95

Worksheet 1C -- Multiple-Vehicle Nondriveway Collisions by Severity Level for Urban and Suburban Roadway Segments									
(1)	(2)		(3)	(4)	(5)	(6)	(7)	(8)	(9)
Crash Severity Level	SPF Coefficients		Overdispersion Parameter, k	Initial N _{brmv}	Proportion of Total Crashes	Adjusted N _{brmv}	Combined CMFs	Calibration Factor, Cr	Predicted N _{brmv}
	a	b							
Total	-15.22	1.68	0.84	0.591	1.000	0.591	0.95	1.00	0.561
Fatal and Injury (FI)	-16.22	1.66	0.65	0.179	(4) _{FI} /((4) _{FI} +(4) _{PDO}) 0.290	0.172	0.95	1.00	0.163
Property Damage Only (PDO)	-15.62	1.69	0.87	0.437	(5) _{TOTAL} -(5) _{FI} 0.710	0.420	0.95	1.00	0.398

Worksheet 1D -- Multiple-Vehicle Nondriveway Collisions by Collision Type for Urban and Suburban Roadway Segments					
(1)	(2)	(3)	(4)	(5)	(6)
Collision Type	Proportion of Collision Type _(FI)	Predicted N _{brmv (FI)} (crashes/year)	Proportion of Collision Type _(PDO)	Predicted N _{brmv (PDO)} (crashes/year)	Predicted N _{brmv (TOTAL)} (crashes/year)
	from Table 12-4	(9) _{FI} from Worksheet 1C	from Table 12-4	(9) _{PDO} from Worksheet 1C	(9) _{TOTAL} from Worksheet 1C
Total	1.000	0.163	1.000	0.398	0.561
		(2)*(3) _{FI}		(4)*(5) _{PDO}	(3)+(5)
Rear-end collision	0.730	0.119	0.778	0.310	0.428
Head-on collision	0.068	0.011	0.004	0.002	0.013
Angle collision	0.085	0.014	0.079	0.031	0.045
Sideswipe, same direction	0.015	0.002	0.031	0.012	0.015
Sideswipe, opposite direction	0.073	0.012	0.055	0.022	0.034
Other multiple-vehicle collision	0.029	0.005	0.053	0.021	0.026

Worksheet 1E -- Single-Vehicle Collisions by Severity Level for Urban and Suburban Roadway Segments									
(1)	(2)		(3)	(4)	(5)	(6)	(7)	(8)	(9)
Crash Severity Level	SPF Coefficients		Overdispersion Parameter, k	Initial N _{brsv}	Proportion of Total Crashes	Adjusted N _{brsv}	Combined CMFs	Calibration Factor, Cr	Predicted N _{brsv}
	from Table 12-5								
	a	b							
Total	-5.47	0.56	0.81	0.173	1.000	0.173	0.95	1.00	0.164
Fatal and Injury (FI)	-3.96	0.23	0.50	0.031	(4) _{FI} /((4) _{FI} +(4) _{PDO}) 0.187	0.032	0.95	1.00	0.031
Property Damage Only (PDO)	-6.51	0.64	0.87	0.134	(5) _{TOTAL} -(5) _{FI} 0.813	0.140	0.95	1.00	0.133

Worksheet 1F -- Single-Vehicle Collisions by Collision Type for Urban and Suburban Roadway Segments					
(1)	(2)	(3)	(4)	(5)	(6)
Collision Type	Proportion of Collision Type _(FI)	Predicted N _{brsv (FI)} (crashes/year)	Proportion of Collision Type _(PDO)	Predicted N _{brsv (PDO)} (crashes/year)	Predicted N _{brsv (TOTAL)} (crashes/year)
	from Table 12-6	(9) _{FI} from Worksheet 1E	from Table 12-6	(9) _{PDO} from Worksheet 1E	(9) _{TOTAL} from Worksheet 1E
Total	1.000	0.031	1.000	0.133	0.164
		(2)*(3) _{FI}		(4)*(5) _{PDO}	(3)+(5)
Collision with animal	0.026	0.001	0.066	0.009	0.010
Collision with fixed object	0.723	0.022	0.759	0.101	0.123
Collision with other object	0.010	0.000	0.013	0.002	0.002
Other single-vehicle collision	0.241	0.007	0.162	0.022	0.029

Worksheet 1G -- Multiple-Vehicle Driveway-Related Collisions by Driveway Type for Urban and Suburban Roadway Segments					
(1)	(2)	(3)	(4)	(5)	(6)
Driveway Type	Number of driveways, n_j	Crashes per driveway per year, N_i	Coefficient for traffic adjustment, t	Initial N_{brdwy}	Overdispersion parameter, k
		from Table 12-7	from Table 12-7	Equation 12-16 $n_j * N_j * (AADT/15,000)^t$	from Table 12-7
Major commercial	0	0.158	1.000	0.000	--
Minor commercial	0	0.050	1.000	0.000	
Major industrial/institutional	0	0.172	1.000	0.000	
Minor industrial/institutional	0	0.023	1.000	0.000	
Major residential	0	0.083	1.000	0.000	
Minor residential	0	0.016	1.000	0.000	
Other	0	0.025	1.000	0.000	
Total	--	--	--	0.000	0.81

Worksheet 1H -- Multiple-Vehicle Driveway-Related Collisions by Severity Level for Urban and Suburban Roadway Segments						
(1)	(2)	(3)	(4)	(5)	(6)	(7)
Crash Severity Level	Initial N_{brdwy}	Proportion of total crashes (f_{dwy})	Adjusted N_{brdwy}	Combined CMFs	Calibration factor, C_r	Predicted N_{brdwy}
	(5) _{TOTAL} from Worksheet 1G	from Table 12-7	(2) _{TOTAL} * (3)	(6) from Worksheet 1B		(4)*(5)*(6)
Total	0.000	1.000	0.000	0.95	1.00	0.000
Fatal and injury (FI)	--	0.323	0.000	0.95	1.00	0.000
Property damage only (PDO)	--	0.677	0.000	0.95	1.00	0.000

Worksheet 1I -- Vehicle-Pedestrian Collisions for Urban and Suburban Roadway Segments							
(1)	(2)	(3)	(4)	(5)	(6)	(7)	(8)
Crash Severity Level	Predicted N_{brmv}	Predicted N_{brsv}	Predicted N_{brdwy}	Predicted N_{br}	f_{pedr}	Calibration factor, C_r	Predicted N_{pedr}
	(9) from Worksheet 1C	(9) from Worksheet 1E	(7) from Worksheet 1H	(2)+(3)+(4)	from Table 12-8		(5)*(6)*(7)
Total	0.561	0.164	0.000	0.724	0.036	1.00	0.026
Fatal and injury (FI)	--	--	--	--	--	1.00	0.026

Worksheet 1J -- Vehicle-Bicycle Collisions for Urban and Suburban Roadway Segments							
(1)	(2)	(3)	(4)	(5)	(6)	(7)	(8)
Crash Severity Level	Predicted N_{brmv}	Predicted N_{brsv}	Predicted N_{brdwy}	Predicted N_{br}	f_{biker}	Calibration factor, C_r	Predicted N_{biker}
	(9) from Worksheet 1C	(9) from Worksheet 1E	(7) from Worksheet 1H	(2)+(3)+(4)	from Table 12-9		(5)*(6)*(7)
Total	0.561	0.164	0.000	0.724	0.018	1.00	0.013
Fatal and injury (FI)	--	--	--	--	--	1.00	0.013

Worksheet 1K -- Crash Severity Distribution for Urban and Suburban Roadway Segments			
(1)	(2)	(3)	(4)
Collision type	Fatal and injury (FI)	Property damage only (PDO)	Total
	(3) from Worksheet 1D and 1F; (7) from Worksheet 1H; and (8) from Worksheet 1I and 1J	(5) from Worksheet 1D and 1F; and (7) from Worksheet 1H	(6) from Worksheet 1D and 1F; (7) from Worksheet 1H; and (8) from Worksheet 1I and 1J
MULTIPLE-VEHICLE			
Rear-end collisions (from Worksheet 1D)	0.119	0.310	0.428
Head-on collisions (from Worksheet 1D)	0.011	0.002	0.013
Angle collisions (from Worksheet 1D)	0.014	0.031	0.045
Sideswipe, same direction (from Worksheet 1D)	0.002	0.012	0.015
Sideswipe, opposite direction (from Worksheet 1D)	0.012	0.022	0.034
Driveway-related collisions (from Worksheet 1H)	0.000	0.000	0.000
Other multiple-vehicle collision (from Worksheet 1D)	0.005	0.021	0.026
Subtotal	0.163	0.398	0.561
SINGLE-VEHICLE			
Collision with animal (from Worksheet 1F)	0.001	0.009	0.010
Collision with fixed object (from Worksheet 1F)	0.022	0.101	0.123
Collision with other object (from Worksheet 1F)	0.000	0.002	0.002
Other single-vehicle collision (from Worksheet 1F)	0.007	0.022	0.029
Collision with pedestrian (from Worksheet 1I)	0.026	0.000	0.026
Collision with bicycle (from Worksheet 1J)	0.013	0.000	0.013
Subtotal	0.070	0.133	0.203
Total	0.232	0.531	0.763

Worksheet 1L -- Summary Results for Urban and Suburban Roadway Segments			
(1)	(2)	(3)	(4)
Crash Severity Level	Predicted average crash frequency, N_{predicted rs} (crashes/year)	Roadway segment length, L (mi)	Crash rate (crashes/mi/year)
	(Total) from Worksheet 1K		(2) / (3)
Total	0.8	0.17	4.5
Fatal and injury (FI)	0.2	0.17	1.4
Property damage only (PDO)	0.5	0.17	3.1

Worksheet 1K -- Crash Severity Distribution for Urban and Suburban Roadway Segments			
(1)	(2)	(3)	(4)
Collision type	Fatal and injury (FI)	Property damage only (PDO)	Total
	(3) from Worksheet 1D and 1F; (7) from Worksheet 1H; and (8) from Worksheet 1I and 1J	(5) from Worksheet 1D and 1F; and (7) from Worksheet 1H	(6) from Worksheet 1D and 1F; (7) from Worksheet 1H; and (8) from Worksheet 1I and 1J
MULTIPLE-VEHICLE			
Rear-end collisions (from Worksheet 1D)	0.108	0.284	0.392
Head-on collisions (from Worksheet 1D)	0.010	0.001	0.012
Angle collisions (from Worksheet 1D)	0.013	0.029	0.041
Sideswipe, same direction (from Worksheet 1D)	0.002	0.011	0.014
Sideswipe, opposite direction (from Worksheet 1D)	0.011	0.020	0.031
Driveway-related collisions (from Worksheet 1H)	0.000	0.000	0.000
Other multiple-vehicle collision (from Worksheet 1D)	0.004	0.019	0.024
Subtotal	0.148	0.365	0.513
SINGLE-VEHICLE			
Collision with animal (from Worksheet 1F)	0.001	0.007	0.007
Collision with fixed object (from Worksheet 1F)	0.016	0.079	0.095
Collision with other object (from Worksheet 1F)	0.000	0.001	0.002
Other single-vehicle collision (from Worksheet 1F)	0.005	0.017	0.022
Collision with pedestrian (from Worksheet 1I)	0.023	0.000	0.023
Collision with bicycle (from Worksheet 1J)	0.012	0.000	0.012
Subtotal	0.057	0.104	0.161
Total	0.205	0.468	0.674

Worksheet 1L -- Summary Results for Urban and Suburban Roadway Segments			
(1)	(2)	(3)	(4)
Crash Severity Level	Predicted average crash frequency, N_{predicted rs} (crashes/year)	Roadway segment length, L (mi)	Crash rate (crashes/mi/year)
	(Total) from Worksheet 1K		(2) / (3)
Total	0.7	0.11	6.1
Fatal and injury (FI)	0.2	0.11	1.9
Property damage only (PDO)	0.5	0.11	4.3

Worksheet 1A -- General Information and Input Data for Urban and Suburban Roadway Segments			
General Information		Location Information	
Analyst	SZ	Roadway	Embarcadero
Agency or Company	Fehr & Peers	Roadway Section	8th Ave to 9th Ave
Date Performed	12/26/18	Jurisdiction	Oakland, CA
		Analysis Year	2018
Input Data		Base Conditions	Site Conditions
Roadway type (2U, 3T, 4U, 4D, ST)		--	2U
Length of segment, L (mi)		--	0.046
AADT (veh/day)	AADT _{MAX} = 32,600 (veh/day)	--	18,120
Type of on-street parking (none/parallel/angle)		None	None
Proportion of curb length with on-street parking		--	0
Median width (ft) - for divided only		15	Not Present
Lighting (present / not present)		Not Present	Present
Auto speed enforcement (present / not present)		Not Present	Not Present
Major commercial driveways (number)		--	0
Minor commercial driveways (number)		--	0
Major industrial / institutional driveways (number)		--	0
Minor industrial / institutional driveways (number)		--	0
Major residential driveways (number)		--	0
Minor residential driveways (number)		--	0
Other driveways (number)		--	0
Speed Category		--	Posted Speed 30 mph or Lower
Roadside fixed object density (fixed objects / mi)		0	108.7
Offset to roadside fixed objects (ft) [If greater than 30 or Not Present, input 30]		30	30
Calibration Factor, Cr		1.00	1.00

Worksheet 1B -- Crash Modification Factors for Urban and Suburban Roadway Segments					
(1)	(2)	(3)	(4)	(5)	(6)
CMF for On-Street Parking	CMF for Roadside Fixed Objects	CMF for Median Width	CMF for Lighting	CMF for Automated Speed Enforcement	Combined CMF
<i>CMF 1r</i>	<i>CMF 2r</i>	<i>CMF 3r</i>	<i>CMF 4r</i>	<i>CMF 5r</i>	<i>CMF comb</i>
from Equation 12-32	from Equation 12-33	from Table 12-22	from Equation 12-34	from Section 12.7.1	(1)*(2)*(3)*(4)*(5)
1.00	1.22	1.00	0.93	1.00	1.14

Worksheet 1C -- Multiple-Vehicle Nondriveway Collisions by Severity Level for Urban and Suburban Roadway Segments									
(1)	(2)		(3)	(4)	(5)	(6)	(7)	(8)	(9)
Crash Severity Level	SPF Coefficients		Overdispersion Parameter, k	Initial N _{brmv}	Proportion of Total Crashes	Adjusted N _{brmv}	Combined CMFs	Calibration Factor, Cr	Predicted N _{brmv}
	a	b							
Total	-15.22	1.68	0.84	0.161	1.000	0.161	1.14	1.00	0.183
Fatal and Injury (FI)	-16.22	1.66	0.65	0.049	$\frac{(4)_{FI}}{((4)_{FI}+(4)_{PDO}}$	0.047	1.14	1.00	0.053
Property Damage Only (PDO)	-15.62	1.69	0.87	0.119	$\frac{(5)_{TOTAL}-(5)_{FI}}{0.710}$	0.114	1.14	1.00	0.130

Worksheet 1D -- Multiple-Vehicle Nondriveway Collisions by Collision Type for Urban and Suburban Roadway Segments					
(1)	(2)	(3)	(4)	(5)	(6)
Collision Type	Proportion of Collision Type _(FI)	Predicted N _{brmv (FI)} (crashes/year)	Proportion of Collision Type _(PDO)	Predicted N _{brmv (PDO)} (crashes/year)	Predicted N _{brmv (TOTAL)} (crashes/year)
	from Table 12-4	(9) _{FI} from Worksheet 1C	from Table 12-4	(9) _{PDO} from Worksheet 1C	(9) _{TOTAL} from Worksheet 1C
Total	1.000	0.053	1.000	0.130	0.183
		(2)*(3) _{FI}		(4)*(5) _{PDO}	(3)+(5)
Rear-end collision	0.730	0.039	0.778	0.101	0.140
Head-on collision	0.068	0.004	0.004	0.001	0.004
Angle collision	0.085	0.005	0.079	0.010	0.015
Sideswipe, same direction	0.015	0.001	0.031	0.004	0.005
Sideswipe, opposite direction	0.073	0.004	0.055	0.007	0.011
Other multiple-vehicle collision	0.029	0.002	0.053	0.007	0.008

Worksheet 1E -- Single-Vehicle Collisions by Severity Level for Urban and Suburban Roadway Segments									
(1)	(2)		(3)	(4)	(5)	(6)	(7)	(8)	(9)
Crash Severity Level	SPF Coefficients		Overdispersion Parameter, k	Initial N _{brsv}	Proportion of Total Crashes	Adjusted N _{brsv}	Combined CMFs (6) from Worksheet	Calibration Factor, Cr	Predicted N _{brsv}
	from Table 12-5		from Table 12-5	from Equation 12-13		(4) _{TOTAL} *(5)			(6)*(7)*(8)
	a	b							
Total	-5.47	0.56	0.81	0.047	1.000	0.047	1.14	1.00	0.054
Fatal and Injury (FI)	-3.96	0.23	0.50	0.008	(4) _{FI} /((4) _{FI} +(4) _{PDO}) 0.187	0.009	1.14	1.00	0.010
Property Damage Only (PDO)	-6.51	0.64	0.87	0.036	(5) _{TOTAL} -(5) _{FI} 0.813	0.038	1.14	1.00	0.044

Worksheet 1F -- Single-Vehicle Collisions by Collision Type for Urban and Suburban Roadway Segments					
(1)	(2)	(3)	(4)	(5)	(6)
Collision Type	Proportion of Collision Type _(FI)	Predicted N _{brsv (FI)} (crashes/year)	Proportion of Collision Type _(PDO)	Predicted N _{brsv (PDO)} (crashes/year)	Predicted N _{brsv (TOTAL)} (crashes/year)
	from Table 12-6	(9) _{FI} from Worksheet 1E	from Table 12-6	(9) _{PDO} from Worksheet 1E	(9) _{TOTAL} from Worksheet 1E
Total	1.000	0.010	1.000	0.044	0.054
		(2)*(3) _{FI}		(4)*(5) _{PDO}	(3)+(5)
Collision with animal	0.026	0.000	0.066	0.003	0.003
Collision with fixed object	0.723	0.007	0.759	0.033	0.040
Collision with other object	0.010	0.000	0.013	0.001	0.001
Other single-vehicle collision	0.241	0.002	0.162	0.007	0.009

Worksheet 1G -- Multiple-Vehicle Driveway-Related Collisions by Driveway Type for Urban and Suburban Roadway Segments					
(1)	(2)	(3)	(4)	(5)	(6)
Driveway Type	Number of driveways, n_j	Crashes per driveway per year, N_j	Coefficient for traffic adjustment, t	Initial N_{brdwy}	Overdispersion parameter, k
		from Table 12-7	from Table 12-7	Equation 12-16 $n_j * N_j * (AADT/15,000)^t$	from Table 12-7
Major commercial	0	0.158	1.000	0.000	--
Minor commercial	0	0.050	1.000	0.000	
Major industrial/institutional	0	0.172	1.000	0.000	
Minor industrial/institutional	0	0.023	1.000	0.000	
Major residential	0	0.083	1.000	0.000	
Minor residential	0	0.016	1.000	0.000	
Other	0	0.025	1.000	0.000	
Total	--	--	--	0.000	0.81

Worksheet 1H -- Multiple-Vehicle Driveway-Related Collisions by Severity Level for Urban and Suburban Roadway Segments						
(1)	(2)	(3)	(4)	(5)	(6)	(7)
Crash Severity Level	Initial N_{brdwy}	Proportion of total crashes (f_{dwy})	Adjusted N_{brdwy}	Combined CMFs	Calibration factor, C_r	Predicted N_{brdwy}
	(5) _{TOTAL} from Worksheet 1G	from Table 12-7	(2) _{TOTAL} * (3)	(6) from Worksheet 1B		(4)*(5)*(6)
Total	0.000	1.000	0.000	1.14	1.00	0.000
Fatal and injury (FI)	--	0.323	0.000	1.14	1.00	0.000
Property damage only (PDO)	--	0.677	0.000	1.14	1.00	0.000

Worksheet 1I -- Vehicle-Pedestrian Collisions for Urban and Suburban Roadway Segments							
(1)	(2)	(3)	(4)	(5)	(6)	(7)	(8)
Crash Severity Level	Predicted N_{brmv}	Predicted N_{brsv}	Predicted N_{brdwy}	Predicted N_{br}	f_{pedr}	Calibration factor, C_r	Predicted N_{pedr}
	(9) from Worksheet 1C	(9) from Worksheet 1E	(7) from Worksheet 1H	(2)+(3)+(4)	from Table 12-8		(5)*(6)*(7)
Total	0.183	0.054	0.000	0.237	0.036	1.00	0.009
Fatal and injury (FI)	--	--	--	--	--	1.00	0.009

Worksheet 1J -- Vehicle-Bicycle Collisions for Urban and Suburban Roadway Segments							
(1)	(2)	(3)	(4)	(5)	(6)	(7)	(8)
Crash Severity Level	Predicted N_{brmv}	Predicted N_{brsv}	Predicted N_{brdwy}	Predicted N_{br}	f_{biker}	Calibration factor, C_r	Predicted N_{biker}
	(9) from Worksheet 1C	(9) from Worksheet 1E	(7) from Worksheet 1H	(2)+(3)+(4)	from Table 12-9		(5)*(6)*(7)
Total	0.183	0.054	0.000	0.237	0.018	1.00	0.004
Fatal and injury (FI)	--	--	--	--	--	1.00	0.004

Worksheet 1K -- Crash Severity Distribution for Urban and Suburban Roadway Segments			
(1)	(2)	(3)	(4)
Collision type	Fatal and injury (FI)	Property damage only (PDO)	Total
	(3) from Worksheet 1D and 1F; (7) from Worksheet 1H; and (8) from Worksheet 1I and 1J	(5) from Worksheet 1D and 1F; and (7) from Worksheet 1H	(6) from Worksheet 1D and 1F; (7) from Worksheet 1H; and (8) from Worksheet 1I and 1J
MULTIPLE-VEHICLE			
Rear-end collisions (from Worksheet 1D)	0.039	0.101	0.140
Head-on collisions (from Worksheet 1D)	0.004	0.001	0.004
Angle collisions (from Worksheet 1D)	0.005	0.010	0.015
Sideswipe, same direction (from Worksheet 1D)	0.001	0.004	0.005
Sideswipe, opposite direction (from Worksheet 1D)	0.004	0.007	0.011
Driveway-related collisions (from Worksheet 1H)	0.000	0.000	0.000
Other multiple-vehicle collision (from Worksheet 1D)	0.002	0.007	0.008
Subtotal	0.053	0.130	0.183
SINGLE-VEHICLE			
Collision with animal (from Worksheet 1F)	0.000	0.003	0.003
Collision with fixed object (from Worksheet 1F)	0.007	0.033	0.040
Collision with other object (from Worksheet 1F)	0.000	0.001	0.001
Other single-vehicle collision (from Worksheet 1F)	0.002	0.007	0.009
Collision with pedestrian (from Worksheet 1I)	0.009	0.000	0.009
Collision with bicycle (from Worksheet 1J)	0.004	0.000	0.004
Subtotal	0.023	0.044	0.066
Total	0.076	0.174	0.250

Worksheet 1L -- Summary Results for Urban and Suburban Roadway Segments			
(1)	(2)	(3)	(4)
Crash Severity Level	Predicted average crash frequency, N_{predicted rs} (crashes/year)	Roadway segment length, L (mi)	Crash rate (crashes/mi/year)
	(Total) from Worksheet 1K		(2) / (3)
Total	0.2	0.05	5.4
Fatal and injury (FI)	0.1	0.05	1.7
Property damage only (PDO)	0.2	0.05	3.8

Worksheet 1A -- General Information and Input Data for Urban and Suburban Roadway Segments			
General Information		Location Information	
Analyst	SZ	Roadway	Embarcadero
Agency or Company	Fehr & Peers	Roadway Section	9th Ave to 10th Ave
Date Performed	12/26/18	Jurisdiction	Oakland, CA
		Analysis Year	2018
Input Data		Base Conditions	Site Conditions
Roadway type (2U, 3T, 4U, 4D, ST)		--	2U
Length of segment, L (mi)		--	0.049
AADT (veh/day)	AADT _{MAX} = 32,600 (veh/day)	--	18,120
Type of on-street parking (none/parallel/angle)		None	None
Proportion of curb length with on-street parking		--	0
Median width (ft) - for divided only		15	Not Present
Lighting (present / not present)		Not Present	Present
Auto speed enforcement (present / not present)		Not Present	Not Present
Major commercial driveways (number)		--	0
Minor commercial driveways (number)		--	0
Major industrial / institutional driveways (number)		--	0
Minor industrial / institutional driveways (number)		--	0
Major residential driveways (number)		--	0
Minor residential driveways (number)		--	0
Other driveways (number)		--	0
Speed Category		--	Posted Speed 30 mph or Lower
Roadside fixed object density (fixed objects / mi)		0	40.8
Offset to roadside fixed objects (ft) [If greater than 30 or Not Present, input 30]		30	30
Calibration Factor, Cr		1.00	1.00

Worksheet 1B -- Crash Modification Factors for Urban and Suburban Roadway Segments					
(1)	(2)	(3)	(4)	(5)	(6)
CMF for On-Street Parking	CMF for Roadside Fixed Objects	CMF for Median Width	CMF for Lighting	CMF for Automated Speed Enforcement	Combined CMF
<i>CMF 1r</i>	<i>CMF 2r</i>	<i>CMF 3r</i>	<i>CMF 4r</i>	<i>CMF 5r</i>	<i>CMF comb</i>
from Equation 12-32	from Equation 12-33	from Table 12-22	from Equation 12-34	from Section 12.7.1	(1)*(2)*(3)*(4)*(5)
1.00	1.05	1.00	0.93	1.00	0.98

Worksheet 1C -- Multiple-Vehicle Nondriveway Collisions by Severity Level for Urban and Suburban Roadway Segments									
(1)	(2)		(3)	(4)	(5)	(6)	(7)	(8)	(9)
Crash Severity Level	SPF Coefficients		Overdispersion Parameter, k	Initial N _{brmv}	Proportion of Total Crashes	Adjusted N _{brmv}	Combined CMFs	Calibration Factor, Cr	Predicted N _{brmv}
	a	b							
Total	-15.22	1.68	0.84	0.171	1.000	0.171	0.98	1.00	0.167
Fatal and Injury (FI)	-16.22	1.66	0.65	0.052	(4) _{FI} /((4) _{FI} +(4) _{PDO}) 0.290	0.050	0.98	1.00	0.049
Property Damage Only (PDO)	-15.62	1.69	0.87	0.127	(5) _{TOTAL} -(5) _{FI} 0.710	0.122	0.98	1.00	0.119

Worksheet 1D -- Multiple-Vehicle Nondriveway Collisions by Collision Type for Urban and Suburban Roadway Segments					
(1) Collision Type	(2) Proportion of Collision Type _(FI)	(3) Predicted N _{brmv (FI)} (crashes/year)	(4) Proportion of Collision Type _(PDO)	(5) Predicted N _{brmv (PDO)} (crashes/year)	(6) Predicted N _{brmv (TOTAL)} (crashes/year)
	from Table 12-4	(9) _{FI} from Worksheet 1C	from Table 12-4	(9) _{PDO} from Worksheet 1C	(9) _{TOTAL} from Worksheet 1C
Total	1.000	0.049	1.000	0.119	0.167
		(2)*(3) _{FI}		(4)*(5) _{PDO}	(3)+(5)
Rear-end collision	0.730	0.035	0.778	0.092	0.128
Head-on collision	0.068	0.003	0.004	0.000	0.004
Angle collision	0.085	0.004	0.079	0.009	0.013
Sideswipe, same direction	0.015	0.001	0.031	0.004	0.004
Sideswipe, opposite direction	0.073	0.004	0.055	0.007	0.010
Other multiple-vehicle collision	0.029	0.001	0.053	0.006	0.008

Worksheet 1E -- Single-Vehicle Collisions by Severity Level for Urban and Suburban Roadway Segments									
(1) Crash Severity Level	(2) SPF Coefficients		(3) Overdispersion Parameter, k	(4) Initial N _{brsv}	(5) Proportion of Total Crashes	(6) Adjusted N _{brsv}	(7) Combined CMFs	(8) Calibration Factor, Cr	(9) Predicted N _{brsv}
	from Table 12-5		from Table 12-5	from Equation 12-13		(4) _{TOTAL} *(5)	(6) from Worksheet		(6)*(7)*(8)
	a	b							
Total	-5.47	0.56	0.81	0.050	1.000	0.050	0.98	1.00	0.049
Fatal and Injury (FI)	-3.96	0.23	0.50	0.009	(4) _{FI} /((4) _{FI} +(4) _{PDO}) 0.187	0.009	0.98	1.00	0.009
Property Damage Only (PDO)	-6.51	0.64	0.87	0.039	(5) _{TOTAL} -(5) _{FI} 0.813	0.041	0.98	1.00	0.040

Worksheet 1F -- Single-Vehicle Collisions by Collision Type for Urban and Suburban Roadway Segments					
(1) Collision Type	(2) Proportion of Collision Type _(FI)	(3) Predicted N _{brsv (FI)} (crashes/year)	(4) Proportion of Collision Type _(PDO)	(5) Predicted N _{brsv (PDO)} (crashes/year)	(6) Predicted N _{brsv (TOTAL)} (crashes/year)
	from Table 12-6	(9) _{FI} from Worksheet 1E	from Table 12-6	(9) _{PDO} from Worksheet 1E	(9) _{TOTAL} from Worksheet 1E
Total	1.000	0.009	1.000	0.040	0.049
		(2)*(3) _{FI}		(4)*(5) _{PDO}	(3)+(5)
Collision with animal	0.026	0.000	0.066	0.003	0.003
Collision with fixed object	0.723	0.007	0.759	0.030	0.037
Collision with other object	0.010	0.000	0.013	0.001	0.001
Other single-vehicle collision	0.241	0.002	0.162	0.006	0.009

Worksheet 1G -- Multiple-Vehicle Driveway-Related Collisions by Driveway Type for Urban and Suburban Roadway Segments					
(1)	(2)	(3)	(4)	(5)	(6)
Driveway Type	Number of driveways, n_j	Crashes per driveway per year, N_j	Coefficient for traffic adjustment, t	Initial N_{brdwy}	Overdispersion parameter, k
		from Table 12-7	from Table 12-7	Equation 12-16 $n_j * N_j * (AADT/15,000)^t$	from Table 12-7
Major commercial	0	0.158	1.000	0.000	--
Minor commercial	0	0.050	1.000	0.000	
Major industrial/institutional	0	0.172	1.000	0.000	
Minor industrial/institutional	0	0.023	1.000	0.000	
Major residential	0	0.083	1.000	0.000	
Minor residential	0	0.016	1.000	0.000	
Other	0	0.025	1.000	0.000	
Total	--	--	--	0.000	0.81

Worksheet 1H -- Multiple-Vehicle Driveway-Related Collisions by Severity Level for Urban and Suburban Roadway Segments						
(1)	(2)	(3)	(4)	(5)	(6)	(7)
Crash Severity Level	Initial N_{brdwy}	Proportion of total crashes (f_{dwy})	Adjusted N_{brdwy}	Combined CMFs	Calibration factor, C_r	Predicted N_{brdwy}
	(5) _{TOTAL} from Worksheet 1G	from Table 12-7	(2) _{TOTAL} * (3)	(6) from Worksheet 1B		(4)*(5)*(6)
Total	0.000	1.000	0.000	0.98	1.00	0.000
Fatal and injury (FI)	--	0.323	0.000	0.98	1.00	0.000
Property damage only (PDO)	--	0.677	0.000	0.98	1.00	0.000

Worksheet 1I -- Vehicle-Pedestrian Collisions for Urban and Suburban Roadway Segments							
(1)	(2)	(3)	(4)	(5)	(6)	(7)	(8)
Crash Severity Level	Predicted N_{brmv}	Predicted N_{brsv}	Predicted N_{brdwy}	Predicted N_{br}	f_{pedr}	Calibration factor, C_r	Predicted N_{pedr}
	(9) from Worksheet 1C	(9) from Worksheet 1E	(7) from Worksheet 1H	(2)+(3)+(4)	from Table 12-8		(5)*(6)*(7)
Total	0.167	0.049	0.000	0.216	0.036	1.00	0.008
Fatal and injury (FI)	--	--	--	--	--	1.00	0.008

Worksheet 1J -- Vehicle-Bicycle Collisions for Urban and Suburban Roadway Segments							
(1)	(2)	(3)	(4)	(5)	(6)	(7)	(8)
Crash Severity Level	Predicted N_{brmv}	Predicted N_{brsv}	Predicted N_{brdwy}	Predicted N_{br}	f_{biker}	Calibration factor, C_r	Predicted N_{biker}
	(9) from Worksheet 1C	(9) from Worksheet 1E	(7) from Worksheet 1H	(2)+(3)+(4)	from Table 12-9		(5)*(6)*(7)
Total	0.167	0.049	0.000	0.216	0.018	1.00	0.004
Fatal and injury (FI)	--	--	--	--	--	1.00	0.004

Worksheet 1K -- Crash Severity Distribution for Urban and Suburban Roadway Segments			
(1)	(2)	(3)	(4)
Collision type	Fatal and injury (FI)	Property damage only (PDO)	Total
	(3) from Worksheet 1D and 1F; (7) from Worksheet 1H; and (8) from Worksheet 1I and 1J	(5) from Worksheet 1D and 1F; and (7) from Worksheet 1H	(6) from Worksheet 1D and 1F; (7) from Worksheet 1H; and (8) from Worksheet 1I and 1J
MULTIPLE-VEHICLE			
Rear-end collisions (from Worksheet 1D)	0.035	0.092	0.128
Head-on collisions (from Worksheet 1D)	0.003	0.000	0.004
Angle collisions (from Worksheet 1D)	0.004	0.009	0.013
Sideswipe, same direction (from Worksheet 1D)	0.001	0.004	0.004
Sideswipe, opposite direction (from Worksheet 1D)	0.004	0.007	0.010
Driveway-related collisions (from Worksheet 1H)	0.000	0.000	0.000
Other multiple-vehicle collision (from Worksheet 1D)	0.001	0.006	0.008
Subtotal	0.049	0.119	0.167
SINGLE-VEHICLE			
Collision with animal (from Worksheet 1F)	0.000	0.003	0.003
Collision with fixed object (from Worksheet 1F)	0.007	0.030	0.037
Collision with other object (from Worksheet 1F)	0.000	0.001	0.001
Other single-vehicle collision (from Worksheet 1F)	0.002	0.006	0.009
Collision with pedestrian (from Worksheet 1I)	0.008	0.000	0.008
Collision with bicycle (from Worksheet 1J)	0.004	0.000	0.004
Subtotal	0.021	0.040	0.060
Total	0.069	0.158	0.228

Worksheet 1L -- Summary Results for Urban and Suburban Roadway Segments			
(1)	(2)	(3)	(4)
Crash Severity Level	Predicted average crash frequency, N_{predicted rs} (crashes/year)	Roadway segment length, L (mi)	Crash rate (crashes/mi/year)
	(Total) from Worksheet 1K		(2) / (3)
Total	0.2	0.05	4.6
Fatal and injury (FI)	0.1	0.05	1.4
Property damage only (PDO)	0.2	0.05	3.2

Attachment E
Congestion Management Program Analysis
Worksheets

**Brooklyn Basin
Alameda CTC Roadway System Analysis Summary - 2020 PM**

Link Location	Segment Limits		A node	B node	# Lanes	Model Volume	Project Trips	Without Project Volume	With Project Volume	% Increase	V/C Ratio Without Project	V/C Ratio With Project	Without Project LOS	With Project LOS	Change from LOS E or better to LOS F	LOS F and Change in V/C >0.03
Freeway Segments																
I-880 Eastbound/Southbound																
Between	7th Street on-ramp	Union Street off-ramp	27500	27498	3	5,107	14	5,107	5,121	0%	0.851	0.854	D	D	No	-
Between	10th Avenue on-ramp	Embarcadero off-ramp	27737	27738	4	8,222	21	8,222	8,243	0%	1.028	1.030	F	F	-	No
I-880 Westbound/Northbound																
Between	23rd Avenue on-ramp	Brooklyn Basin off-ramp	30489	27684	4	7,648	35	7,648	7,683	0%	0.956	0.960	E	E	No	-
Between	Jackson Street on-ramp	Market Street off-ramp	27826	27409	4	5,421	20	5,421	5,441	0%	0.678	0.680	C	C	No	-
Arterials																
East 8th Street Eastbound																
Between	Fallon Street	5th Avenue	30491	28213	3	1,144	21	1,144	1,165	0%	0.424	0.432	B	B	No	-
Between	5th Avenue	14th Street	28213	30545	3	781	9	781	790	0%	0.289	0.293	A	A	No	-
East 8th Street Westbound																
Between	14th Street	5th Avenue	30545	28213	3	266	12	266	278	0%	0.099	0.103	A	A	No	-
Between	5th Avenue	Fallon Street	28213	30491	3	254	15	254	269	0%	0.094	0.100	A	A	No	-
Harrison Street Northbound																
Between	21st Street	Grand Avenue	33552	27919	3	1,159	2	1,159	1,161	0%	0.429	0.430	B	B	No	-
Between	Grand Avenue	27th Street	27919	33560	3	535	2	535	537	0%	0.198	0.199	A	A	No	-
Harrison Street Southbound																
Between	27th Street	Grand Avenue	33560	27919	3	234	1	234	235	0%	0.087	0.087	A	A	No	-
Between	Grand Avenue	21st Street	27919	33552	3	560	2	560	562	0%	0.207	0.208	A	A	No	-
Webster Street Northbound																
Between	Buena Vista Avnue	Atlantic Avenue	30778	28236	2	337	1	337	338	0%	0.187	0.188	A	A	No	-
Between	Atlantic Avenue	Willie Stargell Avenue	28236	33326	2	399	6	399	405	0%	0.221	0.225	A	A	No	-
Webster Street Southbound																
Between	Willie Stargell Avenue	Atlantic Avenue	33326	28236	3	948	5	948	953	0%	0.351	0.353	B	B	No	-
Between	Atlantic Avenue	Buena Vista Avnue	28236	30778	2	584	1	584	585	0%	0.324	0.325	A	A	No	-

Fehr & Peers, 2019.

Brooklyn Basin
Alameda CTC Roadway System Analysis Summary - 2040 PM

Link Location	Segment Limits		A node	B node	# Lanes	Model Volume	Project Trips	Without Project Volume	With Project Volume	% Increase	V/C Ratio Without Project	V/C Ratio With Project	Without Project LOS	With Project LOS	Change from LOS E or better to LOS F	LOS F and Change in V/C >0.03
Freeway Segments																
I-880 Eastbound/Southbound																
Between	7th Street on-ramp	Union Street off-ramp	27500	27498	3	6,237	14	6,237	6,251	0%	1.039	1.042	F	F	-	No
Between	10th Avenue on-ramp	Embarcadero off-ramp	27737	27738	4	10,336	21	10,336	10,357	0%	1.292	1.295	F	F	-	No
I-880 Westbound/Northbound																
Between	23rd Avenue on-ramp	Brooklyn Basin off-ramp	30489	27684	4	8,766	35	8,766	8,801	0%	1.096	1.100	F	F	-	No
Between	Jackson Street on-ramp	Market Street off-ramp	27826	27409	4	6,035	20	6,035	6,055	0%	0.754	0.757	D	D	No	-
Arterials																
East 8th Street Eastbound																
Between	Fallon Street	5th Avenue	30491	28213	3	2,926	21	2,926	2,947	0%	1.084	1.091	F	F	-	No
Between	5th Avenue	14th Street	28213	30545	3	2,727	9	2,727	2,736	0%	1.010	1.013	F	F	-	No
East 8th Street Westbound																
Between	14th Street	5th Avenue	30545	28213	3	608	12	608	620	0%	0.225	0.230	A	A	No	-
Between	5th Avenue	Fallon Street	28213	30491	3	747	15	747	762	0%	0.277	0.282	A	A	No	-
Harrison Street Northbound																
Between	21st Street	Grand Avenue	33552	27919	3	2,431	2	2,431	2,433	0%	0.900	0.901	E	E	No	-
Between	Grand Avenue	27th Street	27919	33560	3	1,517	2	1,517	1,519	0%	0.562	0.563	B	B	No	-
Harrison Street Southbound																
Between	27th Street	Grand Avenue	33560	27919	3	470	1	470	471	0%	0.174	0.175	A	A	No	-
Between	Grand Avenue	21st Street	27919	33552	3	1,106	2	1,106	1,108	0%	0.410	0.410	B	B	No	-
Webster Street Northbound																
Between	Buena Vista Avnue	Atlantic Avenue	30778	28236	2	355	1	355	356	0%	0.197	0.198	A	A	No	-
Between	Atlantic Avenue	Willie Stargell Avenue	28236	33326	2	456	6	456	462	0%	0.253	0.257	A	A	No	-
Webster Street Southbound																
Between	Willie Stargell Avenue	Atlantic Avenue	33326	28236	3	1,300	5	1,300	1,305	0%	0.482	0.483	B	B	No	-
Between	Atlantic Avenue	Buena Vista Avnue	28236	30778	2	937	1	937	938	0%	0.521	0.521	B	B	No	-

Fehr & Peers, 2019.

Attachment F

TDM Plan Recommendations

**RECOMMENDED UPDATES TO THE BROOKLYN BASIN PROJECT TDM PLAN'S
TRANSPORTATION DEMAND MANAGEMENT STRATEGIES**

Program Elements	2014 TDM Plan Recommended Implementation Strategy	Proposed Updates to Implementation Strategies	Required by TIRG	Estimated Vehicle Trip Reduction ^{1,2}
Coordination & Management				
TDM Coordination	The Brooklyn Basin property manager will be responsible for implementing the strategies in this plan.	<ul style="list-style-type: none"> The Brooklyn Basin property manager (or a representative hired by the property manager) will be responsible for implementing all transportation-related programs and strategies in this plan, including but not limited to the Brooklyn Basin shuttle program, AC transit coordination, bicycle parking and network, bikeshare program, bicycle wayfinding and lighting, parking management, ferry program, public promotion, transportation surveys, and annual compliance reporting. The property manager (or a representative hired by the property manager) will ensure that the transportation infrastructure adequately serves all residents and visitors, regardless of age or ability. The property manager (or a representative hired by the property manager) will be responsible for distributing and promoting information concerning active transportation and transit options to all residents. 	✓	
Compliance Reporting	--	<ul style="list-style-type: none"> The property manager (or a representative hired by the property manager) will monitor commute behavior through surveys and data collection to prepare an annual compliance report for the first five years following completion of the project for review and approval by the City. The compliance report should include the status and effectiveness of the TDM program, including the actual vehicle trip reduction achieved by the project during operation. 	✓	
Transit				
Brooklyn Basin Shuttle	There will be frequent, direct weekday shuttle service between Brooklyn Basin and BART. This service could be operated by a private contractor or by AC Transit. Several potential operating models are discussed in this plan document. The preferred option is an extension of the Free B shuttle service to downtown Oakland. If extension of the Free B proves infeasible at the time of implementation, the second option is extension of AC Transit's Route 1 from downtown Oakland to Brooklyn Basin. If an agreement with AC Transit cannot be reached, the third option would be a privately-operated shuttle.	<ul style="list-style-type: none"> The developer will ensure that the Home Owners Association (HOA) documentation includes a requirement that the HOA provide frequent, direct weekday shuttle service between Brooklyn Basin and BART, operated either by AC Transit or a private shuttle service. As an alternative to the HOA shuttle service requirement the developer (or the HOA after it is functioning) could coordinate with AC Transit to achieve route re-alignments to service Brooklyn Basin including either a) extension of either Line 6 or the Free B to connect Brooklyn Basin to Jack London Square, Downtown Oakland, and 12th and 19th Street BART stations or b) re-routing of Lines 62 to connect Brooklyn Basin to the Lake Merritt BART station. The property manager (or a representative hired by the property manager) will ensure that transit stops are appropriately spaced through the project site and are designed to meet industry best practices and AC Transit design guidelines. Major bus stops should include bus boarding bulbs or islands, shelters, real-time arrival information, transit maps, concrete bus pads, benches, adequate lighting, and trash receptacles. 	✓	0.1-8.2%
Other AC Transit service ³	The developer and property manager will work with AC Transit staff to encourage AC to serve the site with one or more frequent routes. Potential service options include re-routing AC Transits Route 1 or extending Route 72 to serve Brooklyn Basin.	<ul style="list-style-type: none"> The property manager (or a representative hired by the property manager) will work with AC Transit staff to encourage AC Transit to serve the site with one or more high-frequency routes, such as: <ul style="list-style-type: none"> Extension of either Line 6 or the Free B to connect Brooklyn Basin to Jack London Square, Downtown Oakland, and 12th and 19th Street BART stations Re-routing of Line 62 to connect Brooklyn Basin to the Lake Merritt BART station Re-routing of Line 72 to connect Brooklyn Basin with other northern Alameda County cities via San Pablo Avenue Adding a Transbay Line OX or S stop along the project frontage to connect Brooklyn Basin with San Francisco If AC Transit provides bus service to Brooklyn Basin the property manager (or a representative hired by the property manager) will work with AC Transit to provide an EasyPass to residents to encourage transit ridership, and encourage employers located on the project site to do the same for their employees. 	✓	

Program Elements	2014 TDM Plan Recommended Implementation Strategy	Proposed Updates to Implementation Strategies	Required by TIRG	Estimated Vehicle Trip Reduction ^{1,2}
Pedestrian and Bicycle Access				
Bicycle network	The development will have a full pedestrian and bicycle network, which will be integrated into the City of Oakland's network, and which will include the proposed Bay Trail connection.	<ul style="list-style-type: none"> The development will have a full pedestrian and bicycle network, which will be integrated into the City of Oakland's network and will include the proposed Bay Trail connection. The developer will implement a Class II bicycle facility on Embarcadero, as called out in the City of Oakland <i>Bicycle Master Plan</i> and shown on development plans for the project. The property manager (or a representative hired by the property manager) will develop a Biking Guide for the project site that includes a City of Oakland Bike Map and bicycle locker and rack locations. The property manager (or a representative hired by the property manager) will provide public bicycle repair stations, including a bicycle stand and tools necessary for tire changes and minor repairs to bicycles. The property manager (or a representative hired by the property manager) will consider implementing a biking incentive program that would include promotions such as providing residents a one-time discount to purchase a new bike. 	✓	
Bicycle parking	The development will provide secure and on-street bicycle parking as outlined in the development plan.	<ul style="list-style-type: none"> The development will provide easy to find and visible short-term bicycle racks adjacent to commercial uses and entrances to residential buildings. The development will provide convenient, easily accessible long-term bicycle parking for residents and employees located on the ground floor of parking garages or off residential building lobbies. Providing secure, easily accessible bicycle parking ensures parking is not a deterrent for residents or employers who may choose to bike and establishes biking as a priority for the development. All provided long-term and short-term bicycle parking will meet the design standards set forth in the City of Oakland <i>Bicycle Master Plan</i> and <i>Planning Code</i>. 	✓	
Bike sharing	The Brooklyn Basin property manager will work with the City of Oakland to advocate for bike share bikeshare stations at the development in case of future expansion of Bay Area Bike Share.	<ul style="list-style-type: none"> The property manager (or a representative hired by the property manager) will work with the City of Oakland to advocate for bike share stations located within the development. The property manager (or a representative hired by the property manager) will coordinate with micro-mobility providers to use tools such as geofencing to ensure that scooters, bikes, and other micro-mobility options are parked in appropriate spaces and maintain accessibility on sidewalk. The property manager (or a representative hired by the property manager) will ensure that Bike share stations, if provided, are placed in strategic locations to promote use, such as residential building entrances, commercial areas, public open space, and at Bay Trail entrances. The property manager (or a representative hired by the property manager) will provide parking spaces for scooters or other micro-mobility options. 		
Wayfinding and lighting	The developer will provide consistent bicycle, pedestrian, transit rider, and vehicle wayfinding and lighting throughout Brooklyn Basin. All bicycle wayfinding will be consistent with City of Oakland and Bay Trail guidelines and standards.	<ul style="list-style-type: none"> The developer will provide consistent bicycle, pedestrian, transit rider, and vehicle wayfinding and lighting throughout Brooklyn Basin. All bicycle wayfinding will be consistent with City of Oakland and Bay Trail guidelines and standards. 		
Pedestrian network	--	<ul style="list-style-type: none"> The developer will ensure pedestrian accessibility to the project site by designing intersections and crosswalks to meet industry best practices. Pedestrian crosswalk safety enhancements include, but are not limited to, bulb outs, median refuges, high-visibility striping, and pedestrian signal improvements. The developer will install green infrastructure, landscaping, and adequate trash receptacles to make walking a viable and enjoyable option. The developer will include a complete pedestrian path and compliment the City of Oakland's Lake Merritt to Bay Trail Connection project. The development will provide accessibility to future Channel Park and existing Bay Trail. The developer will install new sidewalk, curb ramps, and curb and gutter to meet current City and ADA standards and ensure that sidewalk gaps are filled. 	✓	0-2%

Program Elements	2014 TDM Plan Recommended Implementation Strategy	Proposed Updates to Implementation Strategies	Required by TIRG	Estimated Vehicle Trip Reduction ^{1,2}
Parking Management				
Shared commercial parking	Commercial uses will rely on a shared pool of parking.	<ul style="list-style-type: none"> There will be no reserved parking for commercial uses; instead, commercial uses will rely on general public parking spaces and lots. Parking will be priced to ensure transit and biking remain cost-competitive. The property manager (or a representative hired by the property manager) will manage parking resources through on-going monitoring and surveys to ensure that sufficient parking is provided with each development phase. The decision to construct additional parking should take into consideration construction, operation, and maintenance costs compared to expanding transit services, such as increasing shuttle or AC Transit service to the project site. The developer will keep resiliency and retrofit in mind when designing parking infrastructure. With emerging technologies, it is unclear how much longer the personal auto will be a primary mode of transportation. To acknowledge this, parking structures should be designed and constructed to ensure flexibility in future uses if personal autos phase out of the market. 	✓	2.8-5.5%
Unbundled residential parking	Residential parking will be leased to residents. Parking prices will be varied by location as appropriate. If residential units are sold in the future, parking spaces should be maintained as a leased amenity.	<ul style="list-style-type: none"> Residential parking will be unbundled and priced to ensure active and transit modes are financially competitive options. If residential units go for sale, parking spaces should be maintained as a leased amenity. Discounted parking spaces should be available to low-income residents and residents in affordable housing units. 	✓	2.6-13%
Metered on-street parking	On-street parking would be priced using demand-responsive methodology. Note that this measure requires approval and coordination from the City of Oakland.	<ul style="list-style-type: none"> On-street parking will have demand-responsive pricing, like pricing structures employed by SFPark. This will require approval from and coordination with the City of Oakland. At a minimum, parking will be priced to match the cost and inflation of transit to ensure transit remains financially competitive. 		2.8-5.5%
Carsharing	The Brooklyn Basin property manager will work with providers to encourage them to provide car share vehicles located at the development.	<ul style="list-style-type: none"> The property manager (or a representative hired by the property manager) will work with carshare providers to encourage them to provide carshare vehicles on the project site. The property manager (or a representative hired by the property manager) will provide free designated parking spaces for carsharing, such as ZipCar or Gig. The number of carsharing spaces provided should be consistent with City of Oakland <i>Planning Code</i> requirements. The property manager (or a representative hired by the property manager) will provide priority parking for vanpools, carpools, and energy-efficient, low-pollution vehicles. Charging stations for electric vehicles will also be provided per City Code. 		0.4-0.7%
Ferry				
Ferry Service ⁴	If WETA wishes to provide ferry service to the site in the future, work with them to provide terminal space, access, and wayfinding.	<ul style="list-style-type: none"> If WETA wishes to provide ferry service to the site in the future, the property manager (or a representative hired by the property manager) will work with WETA to provide terminal space, access, and wayfinding. 		
<i>Total of all measures</i>				8.7-34.9%

Notes:

- The City of Oakland *Transportation Impact Review Guidelines* requires a project's TDM program to reduce automobile trips by 10 percent for projects generating between 50 and 99 net-new peak hour trips and by 20 percent for projects generating 100 or more net-new peak hour trips. Since the proposed project is expected to generate over 100 AM and PM peak hour trips, the goal of this TDM Program is to reduce the vehicle trips by 20%.
- Vehicle Trip Reduction rates based on California Air Pollution Control Officers Association (CAPCOA) Greenhouse Gas Mitigation Measures
- The City of Oakland's *Transportation Impact Review Guidelines* requires projects to implement a corridor-level transit capital improvement if a high-quality transit facility is in a local or county adopted plan within 0.25 miles of the project location and the project would generate 400 or more peak period transit trips. Embarcadero is the primary facility within a 0.25 mile of the project site; no high-quality transit facilities are proposed on Embarcadero.
- The proposed project includes an on-demand water taxi service operated from Brooklyn Basin and connecting to a variety of key destinations in the San Francisco Bay. The on-demand ferry service is not included in the TDM plan, as service will be limited to one to two days per week. If demand increases and the water taxi begins to operate as a full-service ferry, it will undergo a separate approval process and can then be incorporated into the project's TDM plan.

Source: Fehr & Peers, 2020.

Appendix D
**Air Quality and Greenhouse Gas
Assessment**

MEMO

Date: **March 19, 2021**

To: **Elizabeth Kanner, Senior Managing Associate, ESA**

CC: **Eric Harrison, Vice President, Signature Development Group**

From: **Michael Keinath**
Michael Howley

Subject: **CEQA AIR QUALITY AND GREENHOUSE GAS ASSESSMENT FOR THE OAK TO NINTH AVENUE PROJECT, OAKLAND, CALIFORNIA**

Ramboll US Consulting, Inc. (Ramboll) conducted California Environmental Quality Act (CEQA) analyses for the proposed revisions to the Oak to Ninth Avenue Project (the Project, now known as the Brooklyn Basin Project), in Oakland, California. Specifically, Ramboll has prepared Air Quality (AQ) and Greenhouse Gas (GHG) impact assessments.

Ramboll
2200 Powell Street
Suite 700
Emeryville, CA 94608
USA

T +1 415 796 1950
F +1 415 398 5812
www.ramboll.com

Ramboll understands that the Oak to Ninth Avenue Final Environmental Impact Report (2006 EIR),¹ published in 2006 and recertified in 2009 (2009 EIR),² included 3,100 multi-family residential units, 200,000 square feet of ground-floor retail/commercial and civic spaces, 31 acres of parks and public open space, an existing wetlands restoration area, and improvements and expansion of Clinton Basin marina on a 64 acre parcel. Signature Development has requested an analysis of AQ and GHG impacts of increasing the entitlement for multi-family residential to 3,700 units on the same property and incorporating expanded marina activity (a net increase of 158 slips), including the implementation of a water taxi service.

CEQA THRESHOLDS OF SIGNIFICANCE

The City of Oakland is the lead agency responsible for Project approval. Per City of Oakland requirements and at the direction of the City's consultant, ESA, Ramboll evaluated the Project in accordance with the current Bay Area Air Quality Management District (BAAQMD) CEQA Guidelines, which were updated in May

¹ City of Oakland. 2006. February. ER 04-0009 Oak to Ninth Avenue Project. Final EIR. Available at:

<http://www2.oaklandnet.com/oakca1/groups/ceda/documents/webcontent/oak035552.pdf>

² City of Oakland. 2008. September. ER 04-0009 Oak to Ninth Avenue Project. Revisions to the Analysis in the Oak to Ninth Project EIR (SCH. NO. 2004062013) Prepared to Comply with the Alameda County Superior Court Order in Case No. RG06-280345 and Case No. RG06-280471. Available at:

<http://www2.oaklandnet.com/oakca1/groups/ceda/documents/webcontent/oak035528.pdf>

2017.³ These guidelines present methods for evaluating compliance with CEQA as well as thresholds for determining significance. With respect to the Project, the BAAQMD thresholds of significance are as follows:

BAAQMD CEQA Thresholds of Significance			
Criteria Air Pollutants (and Precursors)	Construction- Related Average Daily Emissions (lbs/day)	Operational-Related	
		Average Daily Emissions (lbs/day)	Maximum Annual Emissions (tons/year)
ROGs	54	54	10
NO _x	54	54	10
PM ₁₀	82 (exhaust only)	82	15
PM _{2.5}	54 (exhaust only)	54	10
PM ₁₀ /PM _{2.5} (fugitive dust)	Best Management Practices	None	
CO (local concentration)	None	9.0 ppm (8-hour average) 20.0 ppm (1-hour average)	
Risks and Hazards for New Sources and Receptors (Individual Project)	Same as Operational Thresholds	Compliance with Qualified Community Risk Reduction Plan OR Increased cancer risk of >10.0 in a million Increased non-cancer risk of > 1.0 HI (chronic or acute) Ambient PM _{2.5} increase: > 0.3 µg/m ³ annual average Zone of Influence: 1,000-foot radius from fence line of source or receptor	
Risks and Hazards for New Sources and Receptors (Cumulative Threshold)	Same as Operational Thresholds	Compliance with Qualified Community Risk Reduction Plan OR Increased cancer risk of >100 in a million (from all local sources) Increased non-cancer risk of >10 HI (from all local sources) (chronic)	

³ BAAQMD. 2017. California Environmental Quality Act (CEQA) Air Quality Guidelines. May. Available online at: http://www.baaqmd.gov/~media/files/planning-and-research/ceqa/ceqa_guidelines_may2017-pdf.pdf?la=en

BAAQMD CEQA Thresholds of Significance			
Criteria Air Pollutants (and Precursors)	Construction- Related Average Daily Emissions (lbs/day)	Operational-Related	
		Average Daily Emissions (lbs/day)	Maximum Annual Emissions (tons/year)
		Ambient PM _{2.5} increase: > 0.8 µg/m ³ annual average (from all local sources)	
		Zone of Influence: 1,000-foot radius from fence line of source or receptor	
Odors	None	Complaint History – five confirmed complaints per year averaged over 3 years	
Abbreviations: BMP = best management practices MT of CO ₂ e/yr = metric tons of carbon dioxide equivalent per year MT CO ₂ e/SP/yr = metric tons carbon dioxide equivalent per service population per year HI = hazard index; µg/m ³ = micrograms per cubic meter.			

At the direction of ESA, this Technical Memorandum evaluates operational criteria air pollutant and GHG emissions for the Project modifications described above with respect to these BAAQMD thresholds of significance. The GHG emissions are evaluated against the City’s GHG threshold, which is:

The project would have a significant impact on the environment if it would:

1. For a project involving a stationary source, produce total emissions of more than 10,000 metric tons of CO₂e annually. [NOTE: Stationary sources are projects that require a BAAQMD permit to operate.]
2. For a project involving a land use development, fail to demonstrate consistency with the 2030 Equitable Climate Action Plan (ECAP) adopted by the City Council on July 28, 2020. [NOTE: Land use developments are projects that do not require a BAAQMD permit to operate.] Consistency with the 2030 ECAP can be shown by either:
 - (a) committing to all of the GHG emissions reductions strategies described on the ECAP Consistency Checklist, or
 - (b) complying with the GHG Reduction Plan Standard Condition of Approval that requires a project-level GHG Reduction Plan quantifying how alternative reduction measures will achieve the same or greater emissions than would be achieved by meeting the ECAP Consistency Checklist.

SUMMARY OF RESULTS

This analysis presents emissions for two scenarios (**Table 1** and **Table 2**). The only difference between the two scenarios is the water taxi service fleet, which is assumed to use all diesel engines in

the first scenario and all-electric engines in the second scenario.⁴ The Project does not exceed any BAAQMD CEQA significance thresholds for criteria air pollutant emissions in either scenario. The Project also is consistent with the ECAP and therefore would not make a cumulatively considerable contribution to significant cumulative GHG impacts.

DATA SOURCES AND EMISSIONS METHODOLOGIES

The following sections describe the input data and methodologies used in the operational emissions analysis. Detailed information for each section can be found in the referenced tables and appendices.

Operational Criteria Air Pollutant Emissions

For all Project emissions except for the water taxi service, Ramboll utilized the California Emission Estimator Model version 2016.3.2 (CalEEMod®)⁵ to quantify operational criteria air pollutant emissions. CalEEMod® is a statewide program designed to calculate both criteria air pollutant emissions for development projects in California. CalEEMod® provides a simple platform to calculate both construction emissions and operational emissions from a land use project. It calculates both the daily maximum and annual average emissions.

CalEEMod® utilizes widely accepted models for emission estimates combined with appropriate default data that can be used if site-specific information is not available. CalEEMod® uses sources such as the US Environmental Protection Agency (USEPA) AP-42 emission factors,⁶ California Air Resources Board's (CARB) on-road and off-road equipment emission models such as the Emission FACTor model (EMFAC) and the Emissions Inventory Program model (OFFROAD), and studies commissioned by California agencies such as the California Energy Commission (CEC) and CalRecycle.

Operational criteria air pollutant emissions from the Project include area source emissions (including emissions from architectural coating, consumer products, and landscaping); emissions from energy use (including natural gas combustion); and operational traffic. As described below, Ramboll updated several default assumptions to Project-specific information to generate emission estimates with CalEEMod®, for consistency with BAAQMD and California Air Pollution Control Officer Association (CAPCOA) methods. Where project-specific data were not available, Ramboll used CalEEMod® defaults for the land uses shown in **Table 3**. An operational year of 2026 was assumed. The CalEEMod® output report is included as **Appendix A**.

Updates to CalEEMod Default Assumptions

In preparing Project operational emissions, Ramboll made several updates to the CalEEMod® default factors and assumptions. These include the following areas:

- Mobile activity: trip generation rates for the Project were updated to be consistent with the Transport Impact Review prepared by Fehr & Peers for the Project.⁷ Consistent with the Fehr &

⁴ According to the ferry company providing service to the Project, the ferry fleet is anticipated to be all-electric within the next five years. For this reason, water taxi fleet electrification is not considered a mitigation for the Project. Ramboll has estimated emissions under both the diesel and electric fleet assumptions to capture the worst-case scenario.

⁵ California Air Pollution Control Officers Association (CAPCOA). 2016. California Emissions Estimator Model. Available at: <http://www.CalEEMod.com/>.

⁶ The USEPA maintains a compilation of Air pollutant Emission Factors and process information for several air pollution source categories. The data is based on source test data, material balance studies, and engineering estimates. Available at: <http://epa.gov/ttnchie1/ap42/>.

⁷ Fehr & Peers. 2021. Brooklyn Basin Density Increase – Transportation Impact Review (non-CEQA). Memorandum to Elizabeth Kanner of ESA. February 17.

Peers memo, weekend trip rates for both land uses were taken from the ITE Trip Generation Manual, 10th Edition. Trip rates and lengths are presented in **Table 4**.

- Woodstoves and hearths – per the Project Sponsor, the Project will not include any hearths or woodstoves, so these have been set to zero.
- Consistent with the City's building electrification ordinance, the buildings with the proposed 600 additional units would have no natural gas. Since all criteria air pollutant emissions from energy use reported by CalEEMod® are from natural gas use, these emissions have been removed.

Recreational Marine Vehicles

As part of the Project, a new marina with 158 boat slips will be constructed. These slips will be occupied by a variety of recreational marine vehicles, such as motorboats and sailboats with auxiliary engines, which will produce operational emissions attributable to the Project. Ramboll calculated these emissions based on outputs from the CARB Pleasure Craft Emissions Inventory.⁸

The database outputs emissions in units of tons/day for recreational marine vehicles grouped by geographic region and vehicle characteristic, by calendar year. Ramboll queried the database for the Project operational year of 2026 and Alameda County, then calculated Project emissions by scaling the county-wide emissions by the ratio of slips added by the Project (158) to the total active vehicle population of Alameda County. These emissions are presented in **Table 5**.

Water Taxi Service

As part of the Project, a water taxi service for project residents will operate from the expanded marina. The water taxi service will be operated by Tideline and consist of a fleet of small watercraft to shuttle residents across the San Francisco Bay. To calculate emissions from the water taxi service, Tideline provided Ramboll with engine parameters for their existing fleet of watercraft, which consists of two Tier 3 diesel-powered vessels. Ramboll assumed the ferry service would operate a maximum of six round trips per weekday, consistent with the Project Description. By the time of Project operations in 2026, an all-electric fleet will be available. Emissions for both scenarios, existing diesel and electrified, are included in this assessment.

Emissions were calculated using Tier 3 emission factors and methodology from CARB.⁹ To be conservative, Ramboll assumed that each vessel had an auxiliary engine in addition to the information provided by Tideline. For the all-electric scenario, no criteria air pollutants would be generated by the fleet. Detailed emissions calculations and assumptions are presented in **Appendix B**.

OAKLAND ECAP CONSISTENCY

Appendix C shows the ECAP Consistency Checklist. The Project modifications include all the GHG emissions reductions strategies described on the ECAP Consistency Checklist. Therefore, the Project modifications would not make a cumulatively considerable contribution to significant cumulative GHG impacts

⁸ CARB. 2014. Spark-Ignition Marine Watercraft (SIMW) Emission Model (CY 2020 to 2050). Available at: <https://ww3.arb.ca.gov/msprog/offroad/recmarine/ab1085compliance.htm>

⁹ CARB. 2012. Appendix B: Emissions Estimation Methodology for Commercial Harbor Craft Operating in California. Available at: <https://ww3.arb.ca.gov/msei/chc-appendix-b-emission-estimates-ver02-27-2012.pdf>

CLOSING

The analysis presented above represent the criteria air pollutant and GHG impacts from operation of the proposed Project. As described above, the Project does not exceed any BAAQMD CEQA significance thresholds applicable to the City of Oakland or the City of Oakland's GHG threshold.

Attachments:

Tables

Appendix A: CalEEMod® Output File

Appendix B: Detailed Water Taxi Emissions Calculations

Appendix C: ECAP Consistency Checklist

TABLES

Table 1
Operational Emissions (Scenario 1: Diesel Fleet)
Brooklyn Basin Project
Oakland, California

Operational Emissions					
Land Use	Category¹	ROG	NO_x	PM₁₀	PM_{2.5}
		(tons/yr)	(tons/yr)	(tons/yr)	(tons/yr)
Output	Area	2.9	0.051	0.025	0.025
	Energy Use ²	--	--	--	--
	Traffic	0.55	3.8	2.3	0.64
	Recreational Marine Vehicles	1.9	0.42	0.10	0.075
	Water Taxi Service (Diesel)	0.21	3.1	0.15	0.15
Total Scenario 1 Operational Emissions		5.5	7.4	2.6	0.88
BAAQMD Significance Threshold		10	10	15	10
Exceed?		NO	NO	NO	NO

Notes:

¹ Annual emissions of criteria air pollutants were estimated using CalEEMod version 2016.3.2 for all operational categories except the water taxi service. See Appendix C for calculation details.

² Consistent with the City of Oakland electrification ordinance, the buildings with the proposed 600 additional residential units will have no natural gas infrastructure. Since all CAP emissions from energy use reported by CalEEMod are from natural gas use, these emissions have been removed.

Abbreviations:

CalEEMod[®] - CALifornia Emissions Estimator MODel

CAP - criteria air pollutant

CO₂e - carbon

GHG - greenhouse gases

MT - metric tons

NO_x - nitrogen oxides

PM_{2.5} - particulate matter < 2.5um in diameter

PM₁₀ - particulate matter < 10um in diameter

ROG - reactive organic gases

yr - year

Table 2
Operational Emissions (Scenario 2: Electric Fleet)
Brooklyn Basin Project
Oakland, California

Operational Emissions					
Land Use	Category¹	ROG	NO_x	PM₁₀	PM_{2.5}
		(tons/yr)	(tons/yr)	(tons/yr)	(tons/yr)
Output	Area	2.9	0.051	0.025	0.025
	Energy Use	--	--	--	--
	Traffic	0.55	3.8	2.3	0.64
	Recreational Marine Vehicles	1.9	0.42	0.10	0.075
	Water Taxi Service (Electric)	--	--	--	--
Total Scenario 2 Operational Emissions		5.3	4.2	2.4	0.74
BAAQMD Significance Threshold		10	10	15	10
Exceed?		NO	NO	NO	NO

Notes:

¹ Annual emissions of criteria air pollutants were estimated using CalEEMod version 2016.3.2 for all operational categories except the water taxi service. See Appendix C for calculation details.

² Consistent with the City of Oakland electrification ordinance, the buildings with the proposed 600 additional residential units will have no natural gas infrastructure. Since all CAP emissions from energy use reported by CalEEMod are from natural gas use, these emissions have been removed.

Abbreviations:

CalEEMod® - CALifornia Emissions Estimator MODel

CAP - criteria air pollutant

CO₂e - carbon

GHG - greenhouse gases

MT - metric tons

NO_x - nitrogen oxides

PM_{2.5} - particulate matter < 2.5um in diameter

PM₁₀ - particulate matter < 10um in diameter

ROG - reactive organic gases

yr - year

Table 3
Proposed Modification Land Uses
Brooklyn Basin Project
Oakland, California

Land Use ¹		Size	Units	Building Square Footage
Mid Rise Apartment	Mid Rise Apartment	600	units	600,000
Marina	Marina	158	slips	0

Notes:

¹ Land uses analyzed based on Project square footages provided by the Project Sponsor.

Table 4
Proposed Modification Trip Generation
Brooklyn Basin Project
Oakland, California

Project Modifications	Land Use Type	Land Use Subtype	ITE Code	Net New Size	Size Metric	Project Trips ¹ (One-Way Trips/Day)			Average Primary Trip Length (miles)	Average Overall Trip Length (miles)
						Weekday	Saturday	Sunday		
Multi-Family Housing (Mid-Rise)	Residential	Apartment Mid-Rise	221	600	DU	2,521	2,275	1,895	7.1	6.3
Marina	Recreational	Marina	420	158	berths	294	318	426	8.0	5.0

Notes:

¹ Trip rates provided by Fehr and Peers and calculated based on the ITE Trip Generation Manual, 10th Edition. To generate Project trips, trip rates were multiplied by net new land use sizes. A City of Oakland trip reduction of 23.1% is also applied for development in an urban environment over one mile from a BART station.

Table 5
Recreational Marine Vehicle Emissions
Brooklyn Basin Project
Oakland, California

Area	Number of Vehicles ²	ROG ³	NO _x	PM ₁₀	PM _{2.5}
		(tons/yr)	(tons/yr)	(tons/yr)	(tons/yr)
Alameda County ¹	30,771	360	83	19	15
Marina (Project) ⁴	158	1.9	0.4	0.10	0.07

Notes:

1. Alameda County data taken from the California Air Resources Board Pleasure Craft Emissions Inventory (2020 - 2050). The database was queried for the Project operational year of 2026, Alameda County, for active status, annual emissions. Emissions reported in tons/day were multiplied by 365 days/year. Database available for download at: <https://ww3.arb.ca.gov/msprog/offroad/recmarine/ab1085compliance.htm>
2. Number of vehicles for Alameda County includes operating and stored vehicles, but excludes inactive ones.
3. ROG emissions include exhaust, diurnal, and evaporative emissions from active vehicles.
4. Project emissions were calculated by scaling Alameda County emissions by the number of recreational vehicles.

Abbreviations:

CFR - Code of Federal Regulations
CO₂e - carbon dioxide equivalents
MT - metric tons
NO_x - nitrogen oxides
PM_{2.5} - particulate matter < 2.5um in diameter
PM₁₀ - particulate matter < 10um in diameter
ROG - reactive organic gases
USEPA - United States Environmental Protection Agency
yr - year

APPENDIX A
CALEEMOD® OUTPUT FILE

Brooklyn Basin Project - Alameda County, Annual

Brooklyn Basin Project
Alameda County, Annual

1.0 Project Characteristics

1.1 Land Usage

Land Uses	Size	Metric	Lot Acreage	Floor Surface Area	Population
User Defined Recreational	166.00	User Defined Unit	0.00	0.00	0
----- Apartments Mid Rise	600.00	Dwelling Unit	0.00	600,000.00	1716

1.2 Other Project Characteristics

Urbanization	Urban	Wind Speed (m/s)	2.2	Precipitation Freq (Days)	63
Climate Zone	5			Operational Year	2026
Utility Company	Pacific Gas & Electric Company				
CO2 Intensity (lb/MWhr)	204	CH4 Intensity (lb/MWhr)	0.029	N2O Intensity (lb/MWhr)	0.006

1.3 User Entered Comments & Non-Default Data

Brooklyn Basin Project - Alameda County, Annual

Project Characteristics - CO2 GHG intensity factor estimated based on PG&E electricity mix assuming achievement of 44% RPS per SB100.

Land Use - User Defined Recreation includes the 166 slip marina expansion.

Construction Phase - Construction removed; operations only run.

Off-road Equipment - Construction removed; operations only run.

Off-road Equipment - Construction removed; operations only run.

Off-road Equipment - Construction removed; operations only run.

Off-road Equipment - Construction removed; operations only run.

Off-road Equipment - Construction removed; operations only run.

Off-road Equipment - Construction removed; operations only run.

Trips and VMT - Construction removed; operations only run.

On-road Fugitive Dust - Construction removed; operations only run.

Demolition - Construction removed; operations only run.

Grading - Construction removed; operations only run.

Architectural Coating - Construction removed; operations only run.

Vehicle Trips - Trip rates per Project traffic study and other Project-specific assumptions.

Woodstoves - Project will no include any hearths, per Project Sponsor.

Energy Use - Title 24 electricity, lighting electricity, and Title 24 natural gas were updated for the 2019 standards.

Water And Wastewater - Indoor water use reduced by 20% from use of water-efficient fixtures.

Table Name	Column Name	Default Value	New Value
tblArchitecturalCoating	ConstArea_Residential_Exterior	405,000.00	0.00
tblArchitecturalCoating	ConstArea_Residential_Interior	1,215,000.00	0.00
tblEnergyUse	LightingElect	741.44	662.11
tblEnergyUse	T24E	426.45	380.82
tblEnergyUse	T24NG	6,115.43	6,054.28
tblFireplaces	NumberGas	90.00	0.00
tblFireplaces	NumberNoFireplace	24.00	600.00

Brooklyn Basin Project - Alameda County, Annual

tblFireplaces	NumberWood	102.00	0.00
tblLandUse	LotAcreage	15.79	0.00
tblOffRoadEquipment	OffRoadEquipmentUnitAmount	1.00	0.00
tblOffRoadEquipment	OffRoadEquipmentUnitAmount	4.00	0.00
tblOffRoadEquipment	OffRoadEquipmentUnitAmount	1.00	0.00
tblOffRoadEquipment	OffRoadEquipmentUnitAmount	1.00	0.00
tblOffRoadEquipment	OffRoadEquipmentUnitAmount	1.00	0.00
tblOffRoadEquipment	OffRoadEquipmentUnitAmount	2.00	0.00
tblOffRoadEquipment	OffRoadEquipmentUnitAmount	1.00	0.00
tblOffRoadEquipment	OffRoadEquipmentUnitAmount	1.00	0.00
tblOffRoadEquipment	OffRoadEquipmentUnitAmount	1.00	0.00
tblOffRoadEquipment	OffRoadEquipmentUnitAmount	1.00	0.00
tblOffRoadEquipment	OffRoadEquipmentUnitAmount	1.00	0.00
tblOffRoadEquipment	OffRoadEquipmentUnitAmount	2.00	0.00
tblOffRoadEquipment	OffRoadEquipmentUnitAmount	2.00	0.00
tblOffRoadEquipment	OffRoadEquipmentUnitAmount	2.00	0.00
tblOffRoadEquipment	OffRoadEquipmentUnitAmount	1.00	0.00
tblOffRoadEquipment	OffRoadEquipmentUnitAmount	1.00	0.00
tblProjectCharacteristics	CO2IntensityFactor	641.35	204
tblTripsAndVMT	VendorTripNumber	64.00	0.00
tblTripsAndVMT	WorkerTripNumber	432.00	0.00
tblTripsAndVMT	WorkerTripNumber	86.00	0.00
tblVehicleTrips	CC_TTP	0.00	48.00
tblVehicleTrips	CNW_TTP	0.00	19.00
tblVehicleTrips	CW_TTP	0.00	33.00
tblVehicleTrips	DV_TP	0.00	39.00
tblVehicleTrips	PB_TP	0.00	9.00

Brooklyn Basin Project - Alameda County, Annual

tblVehicleTrips	PR_TP	0.00	52.00
tblVehicleTrips	ST_TR	6.39	3.79
tblVehicleTrips	ST_TR	0.00	2.02
tblVehicleTrips	SU_TR	5.86	3.16
tblVehicleTrips	SU_TR	0.00	2.70
tblVehicleTrips	WD_TR	6.65	4.20
tblVehicleTrips	WD_TR	0.00	1.87
tblWater	IndoorWaterUseRate	39,092,415.37	31,273,932.00
tblWoodstoves	NumberCatalytic	12.00	0.00
tblWoodstoves	NumberNoncatalytic	12.00	0.00

2.0 Emissions Summary

Brooklyn Basin Project - Alameda County, Annual

Quarter	Start Date	End Date	Maximum Unmitigated ROG + NOX (tons/quarter)	Maximum Mitigated ROG + NOX (tons/quarter)
		Highest		

2.2 Overall Operational

Unmitigated Operational

	ROG	NOx	CO	SO2	Fugitive PM10	Exhaust PM10	PM10 Total	Fugitive PM2.5	Exhaust PM2.5	PM2.5 Total	Bio- CO2	NBio- CO2	Total CO2	CH4	N2O	CO2e
Category	tons/yr										MT/yr					
Area	2.8994	0.0513	4.4524	2.4000e-004		0.0247	0.0247		0.0247	0.0247	0.0000	7.2802	7.2802	6.9800e-003	0.0000	7.4547
Energy	0.0281	0.2397	0.1020	1.5300e-003		0.0194	0.0194		0.0194	0.0194	0.0000	505.0414	505.0414	0.0377	0.0118	509.4929
Mobile	0.5543	3.7606	5.9438	0.0267	2.2943	0.0208	2.3151	0.6164	0.0194	0.6359	0.0000	2,471.6555	2,471.6555	0.0940	0.0000	2,474.0044
Waste						0.0000	0.0000		0.0000	0.0000	56.0255	0.0000	56.0255	3.3110	0.0000	138.8008
Water						0.0000	0.0000		0.0000	0.0000	9.9218	23.6404	33.5622	1.0224	0.0248	66.5005
Total	3.4818	4.0516	10.4981	0.0285	2.2943	0.0649	2.3591	0.6164	0.0635	0.6800	65.9473	3,007.6175	3,073.5648	4.4720	0.0365	3,196.2534

Brooklyn Basin Project - Alameda County, Annual

2.2 Overall Operational

Mitigated Operational

	ROG	NOx	CO	SO2	Fugitive PM10	Exhaust PM10	PM10 Total	Fugitive PM2.5	Exhaust PM2.5	PM2.5 Total	Bio- CO2	NBio- CO2	Total CO2	CH4	N2O	CO2e
Category	tons/yr										MT/yr					
Area	2.8994	0.0513	4.4524	2.4000e-004		0.0247	0.0247		0.0247	0.0247	0.0000	7.2802	7.2802	6.9800e-003	0.0000	7.4547
Energy	0.0281	0.2397	0.1020	1.5300e-003		0.0194	0.0194		0.0194	0.0194	0.0000	505.0414	505.0414	0.0377	0.0118	509.4929
Mobile	0.5543	3.7606	5.9438	0.0267	2.2943	0.0208	2.3151	0.6164	0.0194	0.6359	0.0000	2,471.6555	2,471.6555	0.0940	0.0000	2,474.0044
Waste						0.0000	0.0000		0.0000	0.0000	56.0255	0.0000	56.0255	3.3110	0.0000	138.8008
Water						0.0000	0.0000		0.0000	0.0000	9.9218	23.6404	33.5622	1.0224	0.0248	66.5005
Total	3.4818	4.0516	10.4981	0.0285	2.2943	0.0649	2.3591	0.6164	0.0635	0.6800	65.9473	3,007.6175	3,073.5648	4.4720	0.0365	3,196.2534

	ROG	NOx	CO	SO2	Fugitive PM10	Exhaust PM10	PM10 Total	Fugitive PM2.5	Exhaust PM2.5	PM2.5 Total	Bio- CO2	NBio-CO2	Total CO2	CH4	N2O	CO2e
Percent Reduction	0.00	0.00	0.00	0.00	0.00	0.00	0.00	0.00	0.00	0.00	0.00	0.00	0.00	0.00	0.00	0.00

3.0 Construction Detail

Construction Phase

Brooklyn Basin Project - Alameda County, Annual

Phase Number	Phase Name	Phase Type	Start Date	End Date	Num Days Week	Num Days	Phase Description
1	Demolition	Demolition	6/10/2019	6/9/2019	5	0	
2	Site Preparation	Site Preparation	6/10/2019	6/9/2019	5	0	
3	Grading	Grading	6/10/2019	6/9/2019	5	0	
4	Building Construction	Building Construction	6/10/2019	6/9/2019	5	0	
5	Paving	Paving	6/10/2019	6/9/2019	5	0	
6	Architectural Coating	Architectural Coating	6/10/2019	6/9/2019	5	0	

Acres of Grading (Site Preparation Phase): 0

Acres of Grading (Grading Phase): 0

Acres of Paving: 0

Residential Indoor: 0; Residential Outdoor: 0; Non-Residential Indoor: 0; Non-Residential Outdoor: 0; Striped Parking Area: 0 (Architectural Coating – sqft)

OffRoad Equipment

Brooklyn Basin Project - Alameda County, Annual

Phase Name	Offroad Equipment Type	Amount	Usage Hours	Horse Power	Load Factor
Demolition	Concrete/Industrial Saws	0	8.00	81	0.73
Demolition	Rubber Tired Dozers	0	1.00	247	0.40
Demolition	Tractors/Loaders/Backhoes	0	6.00	97	0.37
Site Preparation	Graders	0	8.00	187	0.41
Site Preparation	Tractors/Loaders/Backhoes	0	8.00	97	0.37
Grading	Concrete/Industrial Saws	0	8.00	81	0.73
Grading	Rubber Tired Dozers	0	1.00	247	0.40
Grading	Tractors/Loaders/Backhoes	0	6.00	97	0.37
Building Construction	Cranes	0	4.00	231	0.29
Building Construction	Forklifts	0	6.00	89	0.20
Building Construction	Tractors/Loaders/Backhoes	0	8.00	97	0.37
Paving	Cement and Mortar Mixers	0	6.00	9	0.56
Paving	Pavers	0	7.00	130	0.42
Paving	Rollers	0	7.00	80	0.38
Paving	Tractors/Loaders/Backhoes	0	7.00	97	0.37
Architectural Coating	Air Compressors	0	6.00	78	0.48

Trips and VMT

Phase Name	Offroad Equipment Count	Worker Trip Number	Vendor Trip Number	Hauling Trip Number	Worker Trip Length	Vendor Trip Length	Hauling Trip Length	Worker Vehicle Class	Vendor Vehicle Class	Hauling Vehicle Class
Demolition	0	0.00	0.00	0.00	10.80	7.30	20.00	LD_Mix	HDT_Mix	HHDT
Site Preparation	0	0.00	0.00	0.00	10.80	7.30	20.00	LD_Mix	HDT_Mix	HHDT
Grading	0	0.00	0.00	0.00	10.80	7.30	20.00	LD_Mix	HDT_Mix	HHDT
Building Construction	0	0.00	0.00	0.00	10.80	7.30	20.00	LD_Mix	HDT_Mix	HHDT
Paving	0	0.00	0.00	0.00	10.80	7.30	20.00	LD_Mix	HDT_Mix	HHDT
Architectural Coating	0	0.00	0.00	0.00	10.80	7.30	20.00	LD_Mix	HDT_Mix	HHDT

Brooklyn Basin Project - Alameda County, Annual

3.7 Architectural Coating - 2019

Mitigated Construction Off-Site

	ROG	NOx	CO	SO2	Fugitive PM10	Exhaust PM10	PM10 Total	Fugitive PM2.5	Exhaust PM2.5	PM2.5 Total	Bio- CO2	NBio- CO2	Total CO2	CH4	N2O	CO2e
Category	tons/yr										MT/yr					
Hauling	0.0000	0.0000	0.0000	0.0000	0.0000	0.0000	0.0000	0.0000	0.0000	0.0000	0.0000	0.0000	0.0000	0.0000	0.0000	0.0000
Vendor	0.0000	0.0000	0.0000	0.0000	0.0000	0.0000	0.0000	0.0000	0.0000	0.0000	0.0000	0.0000	0.0000	0.0000	0.0000	0.0000
Worker	0.0000	0.0000	0.0000	0.0000	0.0000	0.0000	0.0000	0.0000	0.0000	0.0000	0.0000	0.0000	0.0000	0.0000	0.0000	0.0000
Total	0.0000	0.0000	0.0000	0.0000	0.0000	0.0000	0.0000	0.0000	0.0000	0.0000	0.0000	0.0000	0.0000	0.0000	0.0000	0.0000

4.0 Operational Detail - Mobile

4.1 Mitigation Measures Mobile

Brooklyn Basin Project - Alameda County, Annual

	ROG	NOx	CO	SO2	Fugitive PM10	Exhaust PM10	PM10 Total	Fugitive PM2.5	Exhaust PM2.5	PM2.5 Total	Bio- CO2	NBio- CO2	Total CO2	CH4	N2O	CO2e
Category	tons/yr										MT/yr					
Mitigated	0.5543	3.7606	5.9438	0.0267	2.2943	0.0208	2.3151	0.6164	0.0194	0.6359	0.0000	2,471.6555	2,471.6555	0.0940	0.0000	2,474.0044
Unmitigated	0.5543	3.7606	5.9438	0.0267	2.2943	0.0208	2.3151	0.6164	0.0194	0.6359	0.0000	2,471.6555	2,471.6555	0.0940	0.0000	2,474.0044

4.2 Trip Summary Information

Land Use	Average Daily Trip Rate			Unmitigated	Mitigated
	Weekday	Saturday	Sunday	Annual VMT	Annual VMT
Apartments Mid Rise	2,520.00	2,274.00	1896.00	5,533,159	5,533,159
User Defined Recreational	310.42	335.32	448.20	603,017	603,017
Total	2,830.42	2,609.32	2,344.20	6,136,176	6,136,176

4.3 Trip Type Information

Land Use	Miles			Trip %			Trip Purpose %		
	H-W or C-W	H-S or C-C	H-O or C-NW	H-W or C-W	H-S or C-C	H-O or C-NW	Primary	Diverted	Pass-by
Apartments Mid Rise	10.80	4.80	5.70	31.00	15.00	54.00	86	11	3
User Defined Recreational	9.50	7.30	7.30	33.00	48.00	19.00	52	39	9

4.4 Fleet Mix

Land Use	LDA	LDT1	LDT2	MDV	LHD1	LHD2	MHD	HHD	OBUS	UBUS	MCY	SBUS	MH
Apartments Mid Rise	0.564333	0.037157	0.190272	0.104758	0.013838	0.005122	0.025515	0.048164	0.002244	0.002158	0.005408	0.000360	0.000671
User Defined Recreational	0.564333	0.037157	0.190272	0.104758	0.013838	0.005122	0.025515	0.048164	0.002244	0.002158	0.005408	0.000360	0.000671

Brooklyn Basin Project - Alameda County, Annual

5.0 Energy Detail

Historical Energy Use: N

5.1 Mitigation Measures Energy

	ROG	NOx	CO	SO2	Fugitive PM10	Exhaust PM10	PM10 Total	Fugitive PM2.5	Exhaust PM2.5	PM2.5 Total	Bio- CO2	NBio- CO2	Total CO2	CH4	N2O	CO2e
Category	tons/yr										MT/yr					
Electricity Mitigated						0.0000	0.0000		0.0000	0.0000	0.0000	227.4659	227.4659	0.0323	6.6900e-003	230.2680
Electricity Unmitigated						0.0000	0.0000		0.0000	0.0000	0.0000	227.4659	227.4659	0.0323	6.6900e-003	230.2680
NaturalGas Mitigated	0.0281	0.2397	0.1020	1.5300e-003		0.0194	0.0194		0.0194	0.0194	0.0000	277.5755	277.5755	5.3200e-003	5.0900e-003	279.2250
NaturalGas Unmitigated	0.0281	0.2397	0.1020	1.5300e-003		0.0194	0.0194		0.0194	0.0194	0.0000	277.5755	277.5755	5.3200e-003	5.0900e-003	279.2250

Brooklyn Basin Project - Alameda County, Annual

5.2 Energy by Land Use - NaturalGas

Unmitigated

	NaturalGas Use	ROG	NOx	CO	SO2	Fugitive PM10	Exhaust PM10	PM10 Total	Fugitive PM2.5	Exhaust PM2.5	PM2.5 Total	Bio- CO2	NBio- CO2	Total CO2	CH4	N2O	CO2e
Land Use	kBTU/yr	tons/yr										MT/yr					
Apartments Mid Rise	5.20157e+006	0.0281	0.2397	0.1020	1.5300e-003		0.0194	0.0194		0.0194	0.0194	0.0000	277.5755	277.5755	5.3200e-003	5.0900e-003	279.2250
User Defined Recreational	0	0.0000	0.0000	0.0000	0.0000		0.0000	0.0000		0.0000	0.0000	0.0000	0.0000	0.0000	0.0000	0.0000	0.0000
Total		0.0281	0.2397	0.1020	1.5300e-003		0.0194	0.0194		0.0194	0.0194	0.0000	277.5755	277.5755	5.3200e-003	5.0900e-003	279.2250

Mitigated

	NaturalGas Use	ROG	NOx	CO	SO2	Fugitive PM10	Exhaust PM10	PM10 Total	Fugitive PM2.5	Exhaust PM2.5	PM2.5 Total	Bio- CO2	NBio- CO2	Total CO2	CH4	N2O	CO2e
Land Use	kBTU/yr	tons/yr										MT/yr					
Apartments Mid Rise	5.20157e+006	0.0281	0.2397	0.1020	1.5300e-003		0.0194	0.0194		0.0194	0.0194	0.0000	277.5755	277.5755	5.3200e-003	5.0900e-003	279.2250
User Defined Recreational	0	0.0000	0.0000	0.0000	0.0000		0.0000	0.0000		0.0000	0.0000	0.0000	0.0000	0.0000	0.0000	0.0000	0.0000
Total		0.0281	0.2397	0.1020	1.5300e-003		0.0194	0.0194		0.0194	0.0194	0.0000	277.5755	277.5755	5.3200e-003	5.0900e-003	279.2250

Brooklyn Basin Project - Alameda County, Annual

5.3 Energy by Land Use - Electricity

Unmitigated

	Electricity Use	Total CO2	CH4	N2O	CO2e
Land Use	kWh/yr	MT/yr			
Apartments Mid Rise	2.45822e+006	227.4659	0.0323	6.6900e-003	230.2680
User Defined Recreational	0	0.0000	0.0000	0.0000	0.0000
Total		227.4659	0.0323	6.6900e-003	230.2680

Mitigated

	Electricity Use	Total CO2	CH4	N2O	CO2e
Land Use	kWh/yr	MT/yr			
Apartments Mid Rise	2.45822e+006	227.4659	0.0323	6.6900e-003	230.2680
User Defined Recreational	0	0.0000	0.0000	0.0000	0.0000
Total		227.4659	0.0323	6.6900e-003	230.2680

6.0 Area Detail

6.1 Mitigation Measures Area

Brooklyn Basin Project - Alameda County, Annual

	ROG	NOx	CO	SO2	Fugitive PM10	Exhaust PM10	PM10 Total	Fugitive PM2.5	Exhaust PM2.5	PM2.5 Total	Bio- CO2	NBio- CO2	Total CO2	CH4	N2O	CO2e
Category	tons/yr										MT/yr					
Mitigated	2.8994	0.0513	4.4524	2.4000e-004		0.0247	0.0247		0.0247	0.0247	0.0000	7.2802	7.2802	6.9800e-003	0.0000	7.4547
Unmitigated	2.8994	0.0513	4.4524	2.4000e-004		0.0247	0.0247		0.0247	0.0247	0.0000	7.2802	7.2802	6.9800e-003	0.0000	7.4547

6.2 Area by SubCategory

Unmitigated

	ROG	NOx	CO	SO2	Fugitive PM10	Exhaust PM10	PM10 Total	Fugitive PM2.5	Exhaust PM2.5	PM2.5 Total	Bio- CO2	NBio- CO2	Total CO2	CH4	N2O	CO2e
SubCategory	tons/yr										MT/yr					
Architectural Coating	0.4224					0.0000	0.0000		0.0000	0.0000	0.0000	0.0000	0.0000	0.0000	0.0000	0.0000
Consumer Products	2.3433					0.0000	0.0000		0.0000	0.0000	0.0000	0.0000	0.0000	0.0000	0.0000	0.0000
Hearth	0.0000	0.0000	0.0000	0.0000		0.0000	0.0000		0.0000	0.0000	0.0000	0.0000	0.0000	0.0000	0.0000	0.0000
Landscaping	0.1338	0.0513	4.4524	2.4000e-004		0.0247	0.0247		0.0247	0.0247	0.0000	7.2802	7.2802	6.9800e-003	0.0000	7.4547
Total	2.8994	0.0513	4.4524	2.4000e-004		0.0247	0.0247		0.0247	0.0247	0.0000	7.2802	7.2802	6.9800e-003	0.0000	7.4547

Brooklyn Basin Project - Alameda County, Annual

6.2 Area by SubCategory

Mitigated

	ROG	NOx	CO	SO2	Fugitive PM10	Exhaust PM10	PM10 Total	Fugitive PM2.5	Exhaust PM2.5	PM2.5 Total	Bio- CO2	NBio- CO2	Total CO2	CH4	N2O	CO2e
SubCategory	tons/yr										MT/yr					
Architectural Coating	0.4224					0.0000	0.0000		0.0000	0.0000	0.0000	0.0000	0.0000	0.0000	0.0000	0.0000
Consumer Products	2.3433					0.0000	0.0000		0.0000	0.0000	0.0000	0.0000	0.0000	0.0000	0.0000	0.0000
Hearth	0.0000	0.0000	0.0000	0.0000		0.0000	0.0000		0.0000	0.0000	0.0000	0.0000	0.0000	0.0000	0.0000	0.0000
Landscaping	0.1338	0.0513	4.4524	2.4000e-004		0.0247	0.0247		0.0247	0.0247	0.0000	7.2802	7.2802	6.9800e-003	0.0000	7.4547
Total	2.8994	0.0513	4.4524	2.4000e-004		0.0247	0.0247		0.0247	0.0247	0.0000	7.2802	7.2802	6.9800e-003	0.0000	7.4547

7.0 Water Detail

7.1 Mitigation Measures Water

Brooklyn Basin Project - Alameda County, Annual

	Total CO2	CH4	N2O	CO2e
Category	MT/yr			
Mitigated	33.5622	1.0224	0.0248	66.5005
Unmitigated	33.5622	1.0224	0.0248	66.5005

7.2 Water by Land Use

Unmitigated

	Indoor/Outdoor Use	Total CO2	CH4	N2O	CO2e
Land Use	Mgal	MT/yr			
Apartments Mid Rise	31.2739 / 24.6452	33.5622	1.0224	0.0248	66.5005
User Defined Recreational	0 / 0	0.0000	0.0000	0.0000	0.0000
Total		33.5622	1.0224	0.0248	66.5005

Brooklyn Basin Project - Alameda County, Annual

7.2 Water by Land Use

Mitigated

	Indoor/Outdoor Use	Total CO2	CH4	N2O	CO2e
Land Use	Mgal	MT/yr			
Apartments Mid Rise	31.2739 / 24.6452	33.5622	1.0224	0.0248	66.5005
User Defined Recreational	0 / 0	0.0000	0.0000	0.0000	0.0000
Total		33.5622	1.0224	0.0248	66.5005

8.0 Waste Detail

8.1 Mitigation Measures Waste

Category/Year

	Total CO2	CH4	N2O	CO2e
	MT/yr			
Mitigated	56.0255	3.3110	0.0000	138.8008
Unmitigated	56.0255	3.3110	0.0000	138.8008

Brooklyn Basin Project - Alameda County, Annual

8.2 Waste by Land Use

Unmitigated

	Waste Disposed	Total CO2	CH4	N2O	CO2e
Land Use	tons	MT/yr			
Apartments Mid Rise	276	56.0255	3.3110	0.0000	138.8008
User Defined Recreational	0	0.0000	0.0000	0.0000	0.0000
Total		56.0255	3.3110	0.0000	138.8008

Mitigated

	Waste Disposed	Total CO2	CH4	N2O	CO2e
Land Use	tons	MT/yr			
Apartments Mid Rise	276	56.0255	3.3110	0.0000	138.8008
User Defined Recreational	0	0.0000	0.0000	0.0000	0.0000
Total		56.0255	3.3110	0.0000	138.8008

9.0 Operational Offroad

Equipment Type	Number	Hours/Day	Days/Year	Horse Power	Load Factor	Fuel Type
----------------	--------	-----------	-----------	-------------	-------------	-----------

Brooklyn Basin Project - Alameda County, Annual

10.0 Stationary Equipment

Fire Pumps and Emergency Generators

Equipment Type	Number	Hours/Day	Hours/Year	Horse Power	Load Factor	Fuel Type
----------------	--------	-----------	------------	-------------	-------------	-----------

Boilers

Equipment Type	Number	Heat Input/Day	Heat Input/Year	Boiler Rating	Fuel Type
----------------	--------	----------------	-----------------	---------------	-----------

User Defined Equipment

Equipment Type	Number
----------------	--------

11.0 Vegetation

APPENDIX B
DETAILED WATER TAXI EMISSIONS CALCULATIONS

Table B-1
 Water Taxi Emissions Summary
 Brooklyn Basin Project
 Oakland, California

Vessel Name	Engine	PM ₁₀ Engine Emissions (tons/year)	PM _{2.5} Engine Emissions (tons/year)	NO _x Engine Emissions (tons/year)	ROG Engine Emissions (tons/year)
Heron	Main	0.1	0.1	3	0.2
	Auxiliary	0.003	0.003	0.1	0.02
Total		0.2	0.1	3.1	0.2

Table B-2
Water Taxi PM₁₀ Emissions
Brooklyn Basin Project
Oakland, California

Vessel Name	Type of Vessel	Engine	Engine Model Year	Average Number of Engines per Vessel ¹	PM ₁₀			Age (A)	Useful Life (UL)	Horsepower ⁶	Load Factor ⁵	Vessel Trips	Average idling time	Average trip duration	Annual Operating Hours	Adjusted Emission Factor (AEF)	Emissions
				Number	EF ²	F ³	D ⁴	Years	Years	HP	LF	trips/day	minutes/trip-end	minutes	hr	grams/hr	tons/year
Heron	Ferry Boat	Main	2020	2.0	0.14	0.80	0.67	6.0	20	1,001	0.42	6.0	0	22	1,144	116	0.15
		Auxiliary		1.2	0.22	0.80	0.44	6.0	20	116	0.43	6.0	5.0	0	260	12	0.0035

Notes:

¹ Average number of Auxiliary engines per ferry boat from Table II-2 of <https://ww3.arb.ca.gov/msei/chc-appendix-b-emission-estimates-ver02-27-2012.pdf>

² EF in grams/(hp-hr) for Bay Area AQMD from Appendix A of <https://ww3.arb.ca.gov/msei/chc-appendix-b-emission-estimates-ver02-27-2012.pdf>

³ Fuel correction factor (F) from Table II-4 of <https://ww3.arb.ca.gov/msei/chc-appendix-b-emission-estimates-ver02-27-2012.pdf>

⁴ Engine deterioration factor (D) from Table II-5 of <https://ww3.arb.ca.gov/msei/chc-appendix-b-emission-estimates-ver02-27-2012.pdf>

⁵ Load factor (LF) from Table II-3 of <https://ww3.arb.ca.gov/msei/chc-appendix-b-emission-estimates-ver02-27-2012.pdf>

⁶ Horsepower (HP) for Auxiliary engines from "2017 San Francisco Commuter Ferry Emissions"

Calculation:

Emissions = EF x F x (1 + D x A/UL) x HP x LF x hr

hr = [trips/day] x [(Average idling time) + Average trip duration] x 2 x 260 days/year

Abbreviations:

AEF- Adjusted emission factor
AQMD- Air Quality Management District
D- Engine deterioration factor
E- Emissions of pollutant emitted per engine
EF- Emission factor
F- Fuel correction factor
HP- Horsepower
Hr- hour
LF- Load factor
PM₁₀ - Particulate Matter less than 10 microns in diameter

Table B-3
Water Taxi PM_{2.5} Emissions
Brooklyn Basin Project
Oakland, California

Vessel Name	Type of Vessel	Engine	Engine Model Year	Average Number of Engines per Vessel ¹	PM _{2.5}			Age (A)	Useful Life (UL)	Horsepower ⁶	Load Factor ⁵	Vessel Trips	Average idling time	Average trip duration	Annual Operating Hours	Adjusted Emission Factor (AEF)	Emissions
				Number	EF ²	F ³	D ⁴	Years	Years	HP	LF	trips/day	minutes/trip-end	minutes	hr	grams/hr	tons/year
Heron	Ferry Boat	Main	2020	2.0	0.14	0.80	0.67	6.0	20	1,001	0.42	6.0	0	22	1,144	114	0.14
		Auxiliary		1.2	0.22	0.80	0.44	6.0	20	116	0.43	6.0	5.0	0	260	12	0.0035

Notes:

¹ Average number of Auxiliary engines per ferry boat from Table II-2 of <https://ww3.arb.ca.gov/msei/chc-appendix-b-emission-estimates-ver02-27-2012.pdf>

² EF in grams/(hp-hr) for Bay Area AQMD from Appendix A of <https://ww3.arb.ca.gov/msei/chc-appendix-b-emission-estimates-ver02-27-2012.pdf>

³ Fuel correction factor (F) from Table II-4 of <https://ww3.arb.ca.gov/msei/chc-appendix-b-emission-estimates-ver02-27-2012.pdf>

⁴ Engine deterioration factor (D) from Table II-5 of <https://ww3.arb.ca.gov/msei/chc-appendix-b-emission-estimates-ver02-27-2012.pdf>

⁵ Load factor (LF) from Table II-3 of <https://ww3.arb.ca.gov/msei/chc-appendix-b-emission-estimates-ver02-27-2012.pdf>

⁶ Horsepower (HP) for Auxiliary engines from "2017 San Francisco Commuter Ferry Emissions"

Calculation:

$$\text{Emissions} = \text{EF} \times \text{F} \times (1 + \text{D} \times \text{A}/\text{UL}) \times \text{HP} \times \text{LF} \times \text{hr}$$

$$\text{hr} = [\text{trips/day}] \times ([\text{Average idling time}] + \text{Average trip duration}) \times 2 \times 260 \text{ days/year}$$

Abbreviations:

- AEF- Adjusted emission factor
- AQMD- Air Quality Management District
- D- Engine deterioration factor
- E- Emissions of pollutant emitted per engine
- EF- Emission factor
- F- Fuel correction factor
- HP- Horsepower
- Hr- hour
- LF- Load factor
- PM_{2.5} - Particulate Matter less than 2.5 microns in diameter

Table B-4
Water Taxi NO_x Emissions
Brooklyn Basin Project
Oakland, California

Vessel Name	Type of Vessel	Engine	Engine Model Year	Average Number of Engines per Vessel ¹	NO _x			Age (A)	Useful Life (UL)	Horsepower ⁶	Load Factor ⁵	Vessel Trips	Average idling time	Average trip duration	Annual Operating Hours	Adjusted Emission Factor (AEF)	Emissions
				Number	EF ²	F ³	D ⁴	Years	Years	HP	LF	trips/day	minutes/trip-end	minutes	hr	grams/hr	tons/year
Heron	Ferry Boat	Main	2020	2.0	2.9	0.95	0.21	6.0	20	1,001	0.42	6.0	0	22	1,144	2,415	3.0
		Auxiliary		1.2	5.3	0.95	0.14	6.0	20	116	0.43	6.0	5.0	0	260	321	0.092

Notes:

¹ Average number of Auxiliary engines per ferry boat from Table II-2 of <https://ww3.arb.ca.gov/msei/chc-appendix-b-emission-estimates-ver02-27-2012.pdf>

² EF in grams/(hp-hr) for Bay Area AQMD from Appendix A of <https://ww3.arb.ca.gov/msei/chc-appendix-b-emission-estimates-ver02-27-2012.pdf>

³ Fuel correction factor (F) from Table II-4 of <https://ww3.arb.ca.gov/msei/chc-appendix-b-emission-estimates-ver02-27-2012.pdf>

⁴ Engine deterioration factor (D) from Table II-5 of <https://ww3.arb.ca.gov/msei/chc-appendix-b-emission-estimates-ver02-27-2012.pdf>

⁵ Load factor (LF) from Table II-3 of <https://ww3.arb.ca.gov/msei/chc-appendix-b-emission-estimates-ver02-27-2012.pdf>

⁶ Horsepower (HP) for Auxiliary engines from "2017 San Francisco Commuter Ferry Emissions"

Calculation:

Emissions = EF x F x (1 + D x A/UL) x HP x LF x hr

hr = [trips/day] x [(Average idling time) + Average trip duration] x 2 x 260 days/year

Abbreviations:

AEF- Adjusted emission factor
AQMD- Air Quality Management District
D- Engine deterioration factor
E- Emissions of pollutant emitted per engine
EF- Emission factor
F- Fuel correction factor
HP- Horsepower
Hr- hour
LF- Load factor
NO_x - Nitrogen oxides

Table B-5
Water Taxi ROG Emissions
Brooklyn Basin Project
Oakland, California

Vessel Name	Type of Vessel	Engine	Engine Model Year	Average Number of Engines per Vessel ¹	ROG			Age (A)	Useful Life (UL)	Horsepower ⁶	Load Factor ⁵	Vessel Trips	Average idling time	Average trip duration	Annual Operating Hours	Adjusted Emission Factor (AEF)	Emissions
				Number	EF ²	F ³	D ⁴	Years	Years	HP	LF	trips/day	minutes/trip-end	minutes	hr	grams/hr	tons/year
Heron	Ferry Boat	Main	2020	2.00	0.16	1.0	0.44	6.0	20	1,001	0.42	6.0	0	22	1,144	153	0.19
		Auxiliary		1.23	0.81	1.0	0.28	6.0	20	116	0.43	6.0	5.0	0	260	54	0.015

Notes:

- ¹ Average number of Auxiliary engines per ferry boat from Table II-2 of <https://ww3.arb.ca.gov/msei/chc-appendix-b-emission-estimates-ver02-27-2012.pdf>
- ² EF in grams/(hp-hr) for Bay Area AQMD from Appendix A of <https://ww3.arb.ca.gov/msei/chc-appendix-b-emission-estimates-ver02-27-2012.pdf>
- ³ Fuel correction factor (F) from Table II-4 of <https://ww3.arb.ca.gov/msei/chc-appendix-b-emission-estimates-ver02-27-2012.pdf>
- ⁴ Engine deterioration factor (D) from Table II-5 of <https://ww3.arb.ca.gov/msei/chc-appendix-b-emission-estimates-ver02-27-2012.pdf>
- ⁵ Load factor (LF) from Table II-3 of <https://ww3.arb.ca.gov/msei/chc-appendix-b-emission-estimates-ver02-27-2012.pdf>
- ⁶ Horsepower (HP) for Auxiliary engines from "2017 San Francisco Commuter Ferry Emissions"

Calculation:

$$\text{Emissions} = \text{EF} \times \text{F} \times (1 + \text{D} \times \text{A/UL}) \times \text{HP} \times \text{LF} \times \text{hr}$$

$$\text{hr} = [\text{trips/day}] \times ([\text{Average idling time}] + \text{Average trip duration}) \times 2 \times 260 \text{ days/year}$$

Abbreviations:

- AEF- Adjusted emission factor
- AQMD- Air Quality Management District
- D- Engine deterioration factor
- E- Emissions of pollutant emitted per engine
- EF- Emission factor
- F- Fuel correction factor
- HP- Horsepower
- Hr- hour
- LF- Load factor
- ROG - Reactive Organic Gases

APPENDIX C
ECAP CONSISTENCY CHECKLIST



CITY OF OAKLAND

Equitable Climate Action Plan Consistency Checklist

250 Frank H. Ogawa Plaza, Suite 2114, Oakland, CA 94612-2031

Zoning Information: 510-238-3911

<https://www.oaklandca.gov/topics/planning>

The purpose of this Equitable Climate Action Plan Consistency Review Checklist is to determine, for purposes of compliance with the California Environmental Quality Act (CEQA), whether a development project complies with the City of Oakland Equitable Climate Action Plan (ECAP) and the City of Oakland's greenhouse gas (GHG) emissions reduction targets. CEQA Guidelines require the analysis of GHG emissions and potential climate change impacts from new development.

- If a development project completes this Checklist and can qualitatively demonstrate compliance with the Checklist items as part of the project's design, or alternatively, demonstrate to the City's satisfaction why the item is not applicable, then the project will be considered in compliance with the City's CEQA GHG Threshold of Significance.
- If a development project cannot meet all of the Checklist items, the project will alternatively need to demonstrate consistency with the ECAP by complying with the City of Oakland GHG Reduction Plan Condition of Approval.
- If the project cannot demonstrate consistency with the ECAP in either of those two ways, the City will consider the project to have a significant effect on the environment related to GHG emissions.

Application Submittal Requirements

1. The ECAP Consistency Checklist applies to all development projects needing a CEQA GHG emissions analysis, including a specific plan consistency analysis.
2. If required, the ECAP Consistency Review Checklist must be submitted concurrently with the City of Oakland Basic Application.

Application Information

Applicant's Name/Company: Eric Harrison / Signature Development Group

Property Address: 9th Avenue, Oakland, CA

Assessor's Parcel Number: 018-0430-001-14

Phone Number: 510.251.9280

E-mail: eharrison@signaturedevelopment.com

Equitable Climate Action Plan (ECAP) Consistency Review Checklist

Checklist Item (Check the appropriate box and provide explanation for your answer).			
Transportation & Land Use			
1. Is the proposed project substantially consistent with the City's over-all goals for land use and urban form, and/or taking advantage of allowable density and/or floor area ratio (FAR) standards in the City's General Plan? (TLU1)	Yes	No	N/A
	X		
Please explain how the proposed project is substantially consistent with the City's General Plan with respect to density and FAR standards, land use, and urban form.			
Even though the Project seeks a General Plan amendment to permit an additional 600 units to be constructed at Brooklyn Basin, the form (multi-family buildings) and use (residential) are consistent with the City's goals of having multi-family housing at Brooklyn Basin and the additional 600 units can be accommodated within the approved urban form. Increased density at Brooklyn Basin will make Brooklyn Basin's TDM measures, including a shuttle to BART, more effective and will better support the use of Tideline's water taxi service. Increasing access to transit is consistent with the City's goals.			
2. For developments in "Transit Accessible Areas" as defined in the Planning Code, would the project provide: i) less than half the maximum allowable parking, ii) the minimum allowable parking, or iii) take advantage of available parking reductions? (TLU1)	Yes	No	N/A
			X
Please explain how the proposed project meets this action item.			
3. For projects including structured parking, would the structured parking be designed for future adaptation to other uses? (Examples include, but are not limited to: the use of speed ramps instead of sloped floors.). (TLU1)	Yes	No	N/A
	X		
Please explain how the proposed project meets this action item.			
Structured parking garages will be designed with speed ramps rather than sloped floors to provide the potential for future alternative adaptive reuse.			
4. For projects that <i>are</i> subject to a Transportation Demand Management Program, would the project include transit passes for employees and/or residents? (TLU1)	Yes	No	N/A
	X		
Please explain how the proposed project meets this action item.			
The Project's proposed TDM for the 600 new units would meet the intention of City's requirements by providing a free shuttle service between the Project and the Lake Merritt BART station. This means that residents and employees would not need to pay for bus service to get to BART.			

Equitable Climate Action Plan (ECAP) Consistency Review Checklist

<p>5. For projects that are <i>not</i> subject to a Transportation Demand Management Program, would the project incorporate one or more of the optional Transportation Demand Management measures that reduce dependency on single-occupancy vehicles? (Examples include but are not limited to transit passes or subsidies to employees and/or residents; carpooling; vanpooling; or shuttle programs; on-site carshare program; guaranteed ride home programs) (TLU1 & TLU8)</p>	<p>Yes</p>	<p>No</p>	<p>N/A</p>
<p style="text-align: center;">X</p>			
<p>Please explain how the proposed project meets this action item.</p>			
<p>6. Does the project comply with the Plug-In Electric Vehicle (PEV) Charging Infrastructure requirements (Chapter 15.04 of the Oakland Municipal Code), if applicable? (TLU2 & TLU-5)</p>	<p>Yes</p>	<p>No</p>	<p>N/A</p>
<p style="text-align: center;">X</p>			
<p>Please explain how the proposed project meets this action item.</p> <p>The Project will comply with City PEV charging requirements, including by providing PEV charging stations in the parking garages.</p>			
<p>7. Would the project reduce or prevent the direct displacement of residents and essential businesses? (For residential projects, would the project comply with SB 330, if applicable? For projects that demolish an existing commercial space, would the project include comparable square footage of neighborhood serving commercial floor space.) (TLU3)</p>	<p>Yes</p>	<p>No</p>	<p>N/A</p>
<p style="text-align: center;">X</p>			
<p>Please explain how the proposed project meets this action item.</p> <p>The Project does not displace any residents or essential businesses. The Project provides space for new residences and would expand the existing marina.</p>			

Equitable Climate Action Plan (ECAP) Consistency Review Checklist

<p>8. Would the project prioritize sidewalk and curb space consistent with the City's adopted Bike and Pedestrian Plans? (The project should not prevent the City's Bike and Pedestrian Plans from being implemented. For example, do not install a garage entrance where a planned bike path would be unless otherwise infeasible due to Planning Code requirements, limited frontage or other constraints.) (TLU7)</p>	Yes	No	N/A
<p>X</p>			
<p>Please explain how the proposed project meets this action item.</p>			
<p>The Project does not alter the approved Brooklyn Basin land plan, including site access, on-site streets, sidewalks, bike facilities, intersections, and waterfront access. The approved Brooklyn Basin land plan was found to not conflict with plans, ordinances, or policies related to the City's Bike and Pedestrian Plans.</p>			
<p>Buildings</p>			
<p>9. Does the project not create any new natural gas connections/hook-ups? (B1 & B2)</p>	Yes	No	N/A
<p>X</p>			
<p>Please explain how the proposed project meets this action item.</p>			
<p>The Project (the buildings with the 600 new units) would be all electric. No new natural gas connections or hook ups are required.</p>			
<p>10. Does the project comply with the City of Oakland Green Building Ordinance (Chapter 18.02 of the Oakland Municipal Code), if applicable? (B4)</p>	Yes	No	N/A
<p>X</p>			
<p>Please explain how the proposed project meets this action item.</p>			
<p>The Project will be designed to comply with the Green Building ordinance requirements, such as reducing interior and irrigation water demands and including efficient lighting and heating and ventilation systems and would meet or exceed either Build it Green or LEED design criteria.</p>			
<p>11. For retrofits of City-owned or City-controlled buildings: Would the project be all-electric, eliminate gas infrastructure from the building, and integrate energy storage wherever technically feasible and appropriate? (B5)</p>	Yes	No	N/A
<p>X</p>			

Please explain how the proposed project meets this action item.

Equitable Climate Action Plan (ECAP) Consistency Review Checklist

Material Consumption & Waste			
12. Would the project reduce demolition waste from construction and renovation and facilitate material reuse in compliance with the Construction Demolition Ordinance (Chapter 15.34 of the Oakland Municipal Code)? (MCW6)	Yes	No	N/A
	X		
Please explain how the proposed project meets this action item. The Project would submit a waste reduction and recycling plan (WRRP) for the City review and approval prior to obtaining a building permit. The WRRP will ensure that at least 50 percent by weight of all construction and demolition debris generated by the Project will be diverted.			
City Leadership			
13. For City projects: Have opportunities to eliminate/minimize fossil fuel dependency been analyzed in project design and construction? (CL2)	Yes	No	N/A
			X
Please explain how the proposed project meets this action item.			
Adaptation			
14. For new projects in the Designated Very High Wildfire Severity Zone: Would the project incorporate wildfire safety requirements such creation of defensible space around the house, pruning, clearing and removal of vegetation, replacement of fire resistant plants, as required in the Vegetation Management Plan? (A4)	Yes	No	N/A
			X
Please explain how the proposed project meets this action item.			

Equitable Climate Action Plan (ECAP) Consistency Review Checklist

Carbon Removal			
15. Would the project replace a greater number of trees than will be removed in compliance with the Tree Preservation Ordinance (Chapter 12.36 of the Oakland Municipal Code) and Planning Code if applicable and feasible given competing site constraints? (CR-2)	Yes	No	N/A
	X		
Please explain how the proposed project meets this action item. The Project would not alter the plan for any trees from what the City approved in 2009.			
16. Does the project comply with the Creek Protection, Stormwater Management and Discharge Control Ordinance (Chapter 13.16 of the Oakland Municipal Code), as applicable? (CR-3)	Yes	No	N/A
	X		
Please explain how the proposed project meets this action item. The Project would comply with the Creek Protection and Stormwater Management and Discharge Control Ordinances by complying with the mitigation measures in the 2009 EIR prepared for the approved Brooklyn Basin project, the City's standard conditions of approval, and applicable federal and state law.			

I understand that answering *yes* to all of these questions, means that the project *is in compliance with* the City's Energy and Climate Action Plan as adopted on to July 28, 2020 and requires that staff apply the Project Compliance with the Equitable Climate Action Plan (ECAP) Consistency Checklist Condition of Approval as adopted by the Planning Commission on December 16, 2020 and all Checklist items must be incorporated into the project

I understand that answering *no* to any of these questions, means that the project *is not in compliance with* the City's Energy and Climate Action Plan as adopted on to July 28, 2020 and requires that staff apply the Greenhouse Gas (GHG) Reduction Plan Condition of Approval as adopted by the Planning Commission on December 16, 2020 which will require that the applicant prepare a quantitative GHG analysis and GHG Reduction Plan for staff's review and approval. The GHG Reduction Plan and all GHG Reduction measures shall be incorporated into the project and implemented during construction and after construction for the life of the project.

/s/ Eric Harrison

1/26/2021

Appendix E
**Brooklyn Basin Marina Project
Description, Bioacoustic
Evaluation, and Water Quality
Management Plan**



Updated January 2018
Brooklyn Basin Marina



Project Description

Prepared for Brooklyn Basin Marina, LP

Updated January 2018
Brooklyn Basin Marina

Project Description

Prepared for
Brooklyn Basin Marina, LP
3415 Via Lido, Suite G
Newport Beach, California 92663

Prepared by
Anchor QEA, LLC
130 Battery Street, Suite 400
San Francisco, California 94111

TABLE OF CONTENTS

1	Introduction	1
2	Existing Conditions.....	2
2.1	Vegetation.....	2
2.2	Adjacent Areas Not Included in the Project Footprint	3
2.2.1	Adjacent Upland Area.....	3
2.2.2	Adjacent Wetland Area	3
3	Project Activities	4
3.1	Modern Construction	6
3.2	Sewage Pump-out System.....	6
3.3	Utilities.....	6
3.4	Signage	7
3.5	Water Taxi Service.....	7
3.5.1	Overview of Initial Operations.....	7
3.5.2	Expansion of Service.....	8
3.6	Other Improvements.....	8
3.7	Schedule	9
3.8	Staging	10
4	Biological Resources	11
4.1	Special Status Species and Habitats in the Project Area.....	11
4.1.1	ESA-listed Species.....	11
4.1.2	Marine Mammals.....	16
4.1.3	Migratory Bird Treaty Act Protected Birds and Raptors.....	17
4.1.4	Eelgrass.....	17
4.1.5	Essential Fish Habitat	18
4.2	Potential Project Impacts	19
4.2.1	ESA-listed Fish Species.....	19
4.2.2	Marine Mammals.....	20
4.2.3	ESA-listed Shorebirds and Migratory Bird Treaty Act-protected Birds and Raptors	21
4.2.4	Eelgrass.....	21
4.2.5	Essential Fish Habitat	21

5	Avoidance and Minimization of Impacts	22
5.1	Protection of Water Quality during Construction	22
6	Mitigation	24
7	References	25

TABLES

Table 1	Slip Summary	4
Table 2	Pile Summary.....	5
Table 3	Shading of the New Marina (square feet)	6
Table 4	Construction Schedule.....	10
Table 5	Federal ESA- and State ESA-Listed Marine or Shoreline Species with the Potential to Inhabit the Study Area.....	12
Table 6	Species with Designated EFH within the Central San Francisco Bay.....	18

APPENDICES

Appendix A	Photographs of New Marina Features
Appendix B	Bioacoustic Evaluation
Appendix C	Water Quality Management Plan

ABBREVIATIONS

2006 EIR	<i>Oak to Ninth Avenue Project Final Environmental Impact Report (ESA 2006)</i>
ADA	Americans with Disabilities Act
Bay	San Francisco Bay
BCDC	San Francisco Bay Conservation and Development Commission
BMP	best management practice
CDFW	California Department of Fish and Wildlife
CESA	California Endangered Species Act
CNDDDB	California Natural Diversity Database
CPUC	California Public Utilities Commission
ESA	Endangered Species Act
EFH	essential fish habitat
ESU	evolutionarily significant unit
FMP	Fisheries Management Plan
MBTA	Migratory Bird Treaty Act
NMFS	National Marine Fisheries Service
quad	quadrangle
TMG	Tideline Marine Group
USFWS	U.S. Fish and Wildlife Service

1 Introduction

The proposed project consists of installing a new, state-of-the-art marina extending from Clinton Basin to Brooklyn Basin, located in the San Francisco Bay (Bay) tidal channel east of Alameda Island (Figure 1). The new marina would consist of a commercially-available, pre-manufactured concrete floating dock system comprised of 14 docks (Figures 2 and 3; Appendix A). These new docks would provide a total of 218 recreational boat slips ranging from 40 to 80 feet in length. The system would be optimally configured such that the docks wrap along the shoreline beginning immediately east of Ninth Avenue and continue west and then northeast, terminating at the most northern portion of Clinton Basin. One of the docks would also be constructed along the most southwestern portion of Clinton Basin to accommodate larger vessels (up to 80 feet in length), with a long dock extending north along the shoreline.

The project description and supporting information presented herein also includes information suggested in meetings held with City of Oakland project representatives in March 2017, and in subsequent meetings with the U.S. Army Corps of Engineers and the San Francisco Bay Conservation and Development Commission (BCDC) in June 2017.

2 Existing Conditions

The proposed project is located within portions of Brooklyn Basin and Clinton Basin, both located within the Bay tidal channel east of Alameda Island. The Bay tidal channel is a well-developed and highly-trafficked navigational corridor that provides Bay access to these basins and other neighboring facilities, including other marinas.

The shoreline along the project site largely includes unprotected banks and former industrial wharf areas. The shoreline along Clinton Basin, in particular, is characterized by concrete debris, sandy pocket beaches, and unprotected banks. Current shading in the project area can be attributed to the dilapidated and inoperable marina in Clinton Basin, which covers approximately 28,150 square feet and previously provided approximately 20 slips. The marina was last operated around the year 2000, and has remained closed to the public since that time. Since its closure, the marina has not been maintained, and is currently beyond economic repair. Many of the existing creosote-treated wood guide piles are failing, rotten, or otherwise degraded, rendering significant portions of the existing structure in immediate danger of failure and restricted from public access. Demolition of these existing marina components will be completed as part of the proposed Project, as detailed in Section 3.

In addition to the existing marina, timber wharf and concrete bulkhead wrap along the shoreline from the southeast portion of Clinton Basin to the northern terminus of the Ninth Avenue Terminal Building. The wharf consists of over 1,000 vertical timber piles topped with an asphalt concrete slab. Timber fender piles protect the waterside edge of the wharf. The wharf structure frames into a cast-in-place concrete bulkhead. The toe of the wall is protected by riprap.

2.1 Vegetation

Patches of marsh vegetation are found within the areas of riprap along the shoreline and in larger patches west of the Clinton Basin (ESA 2006). Although sparsely distributed, the dominant species include pickleweed (*Salicornia virginica*), saltgrass (*Distichlis spicata*), and dense-flowered cord grass (*Spartina densiflora*) in the remaining soft edges of Clinton Basin. The open water areas within Clinton Basin and at the edge of the project site provide habitat for marine vegetation, including patches of sea lettuce (*Ulva* sp.), brown algae (*Porphyra* sp.), and red algae (*Faucheia* sp.), covering pilings and breakwater structures up to the mean low water level. Eelgrass (*Zostera marina*) has not been recorded within the project area.

2.2 Adjacent Areas Not Included in the Project Footprint

2.2.1 Adjacent Upland Area

The upland area adjacent to the project site is graded and developed, and is free of any wetlands or jurisdictional waters. Although no upland work, dredging, or fill (other than installation of 162 piles) is proposed as part of this project, shoreline improvements are underway as part of the separate and already approved Brooklyn Basin Mixed-Use Development (previously referred to as the Oak to Ninth Avenue Project). Approved shoreline improvements include significant enhancements to public access along the waterfront adjacent to the proposed Brooklyn Basin Marina, such as constructing a publicly-accessible park and promenade. Shoreline reconfiguration and protection measures are also included as part of the Brooklyn Basin Redevelopment Project. New landside facilities will include a harbormaster office, showers and laundry facilities, and boater parking in compliance with the Clean Marina Program. Marina restroom facilities would also be located on the ground floor of a building along Clinton Basin's east and west shorelines.

2.2.2 Adjacent Wetland Area

A wetland enhancement project was previously completed by the Port of Oakland at the Seabreeze Yacht Harbor site located along the southwestern portion of Clinton Basin, outside of the project area. The goal of the enhancement project was to improve habitat conditions for water birds by creating a more naturalistic habitat gradient protected from disturbance by people and dogs. As noted in environmental documentation prepared for the enhancement project, the site is unlikely to be used by threatened or endangered species due to the small extent of tidal marsh in the vicinity (PWA 2001).

3 Project Activities

As stated in Section 1, the project consists of installing a new, state-of-the-art marina extending from Clinton Basin to Brooklyn Basin. The marina would consist of a new, commercially-available, pre-manufactured concrete floating dock system comprising 14 docks (Docks A through M2). The new docks would provide a total of 218 recreational boat slips ranging from 40 to 80 feet in length. The system would be optimally configured such that the docks wrap along the shoreline beginning immediately east of Ninth Avenue (at Dock A) and continue west and then northeast, terminating at the most northern portion of Clinton Basin (at Dock M2). Table 1 summarizes the various slip sizes available at each dock.

**Table 1
Slip Summary**

Length (feet)	Dock ¹														Total Slip Count	Total Slip Mix
	A	B	C	D	E	F	G	H	I	J	K	L1	M1	M2		
40			22	11					4	10	5				52	24 %
45		20			11	22		8	4						65	30 %
50	18			10	10						5			21	64	29 %
60							5						15		20	9%
70												5	7		12	6%
80												5			5	2%
Total	18	20	22	21	21	22	5	8	8	10	10	10	11	32	218	100 %

Notes:

End ties are not included in slip count.

1. Includes Americans with Disabilities Act-accessible slips

Project activities include the disassembly and removal of the existing non-functional dock system in Clinton Basin using a land-based crane, forklift, or waterside barge-mounted crane. Removed docks would be hauled to a landfill or recycling facility by truck. Most of the existing dock modules would not be suitable for recycling because their component materials include treated wood and foam which has been deteriorating in the salt water.

The new dock pontoon system would be manufactured and initially assembled off site in a controlled plant environment, and then shipped to the project site by truck. New manufactured piles would also

be shipped to the project site by truck. Docks would then be placed in the water using a land-based crane or forklift; similarly, piles would be transported to a floating work barge using either a barge-mounted crane or land-based crane. Dock modules would be assembled and connected using hand tools.

Installation of the new marina would begin at Dock A and continue west along the shoreline through Dock M2. Dock L1 would be constructed along the most southwestern portion of the basin directly opposite Dock K to accommodate larger vessels (up to 80 feet in length), with a long dock extending north along the shoreline (opposite Dock M1). Table 1 summarizes the various slip sizes available at each dock.

Guide piles would be steel and installed using a non-diesel-powered drop hammer. The need for the steel piles (versus concrete piles) is based on the substrate of the bay bottom, and is as recommended by the project engineer. A diesel-powered hammer may be used to supplement installation where a drop hammer is unable to achieve a pile’s required depth. Jetting may also be used in stiff surface conditions to accurately erect the pile. Once piles are driven and docks are assembled, the final dock assembly will occur; this process includes installation of fendering, cover boards, wet and dry utilities, and dock components, such as fire standpipes, power centers, and dock boxes. Table 2 summarizes the pilings proposed to support each dock.

**Table 2
Pile Summary**

Diameter (inches)	Dock															Total Pile Count
	A	B	C	D	E	F	G	H	I	J	K	L1	M1	M2	LD	
14												16	15	11	8	50
16							5	2	2	4	2	4	8			27
18	10	9	9	9	10	9	6	5	5	3	6	1	1	1	1	85
Total	9	8	8	8	9	6	10	7	7	7	7	20	23	11	8	162

Note:
LD refers to the long dock that extends along Clinton Basin’s western shoreline.

Upland access to the docks would be provided by seven gangways of various lengths. These gangways would be compliant with the Americans with Disabilities Act (ADA).

Current shading due to solid fill in the project area can be attributed to the existing unusable marina in Clinton Basin, which spans approximately 28,150 square feet. Following installation of the new marina (which would include removal of the existing marina in Clinton Basin), the project would increase shading by solid fill by approximately 86,225 square feet (Table 3).

Table 3
Shading of the New Marina (square feet)

Existing	Proposed	Net Increase
28,150	114,375	86,225

3.1 Modern Construction

The new dock system would require minimum maintenance, and would have a clean, modern appearance that would integrate well with future upland construction in the area. Representative photographs of new marina features and renderings of various viewpoints to and from the marina are included in Appendix A. The concrete walking surface would have a light broom non-skid finish. The dock itself would not be painted and would instead retain the natural color of its various building materials. All pontoon floats would be constructed of expanded polystyrene foam fully encapsulated in lightweight concrete. A fiberglass waler system (instead of traditional timber) would be used to connect individual float modules.

All timber used for the marina would be treated with ammoniacal copper zinc arsenate timber preservative (to a net retention of 0.6 pound per cubic foot) to extend timber life. Although no timber would be submerged in water, all best management practices, as required by the Western Wood Preservers Institute, would be followed to ensure proper treatment. As mentioned above, the fiberglass waler system would also minimize the use of treated timber. Figure 3 presents a typical dock section detailing different parts and materials, including timber sections.

All gangways would be ADA-compliant. The gangways would be designed using aluminum trusses, and newly-installed guide piles would be made of steel and/or pre-stressed concrete.

3.2 Sewage Pump-out System

No pump-out facility currently exists in Clinton Basin or Brooklyn Basin. As such, the new marina would incorporate a central pump-out station for proper sewage disposal. The addition of this free, publicly-accessible pump-out station would be an important amenity for boaters and would help protect and likely improve water quality in the Bay.

3.3 Utilities

Utilities would be installed per current code requirements that protect water quality and public safety. The proposed dock system would use a combination of traditional dock boxes with marina power outlet centers mounted in the front dock box recess area of all standard boat slips. Pedestal-style power outlet centers would be located along end ties where higher levels of power may be required to accommodate a variety of boats that may berth to these end ties. Transformers would also be strategically placed along the main walkways of various docks throughout the marina for power distribution purposes.

Lighting would be provided in both power centers and pedestals. Light-emitting diode (LED) lamps would be installed for localized safety lighting along the main dock walkways and would project light downward.

Based on code requirements, the fire and domestic water piping systems would be separated. Fire water pressure would comply with the City of Oakland Fire Department's requirements.

All dock utilities would be run in and along the new dock floats.

3.4 Signage

The new marina would include on- and off-site directional signs indicating the location of the marina, along with other wayfinding in compliance with the Brooklyn Basin Signage Master Plan. Signage would also be provided to inform the public of consumption advisories for the species of Bay fish that have been identified as having potentially unsafe levels of contaminants.

3.5 Water Taxi Service

To complement the new marina, the proposed project includes expansion of an existing water taxi and small-scale ferry service, initially in a limited capacity, available to the residents of the Brooklyn Basin community and the public. This service is proposed to provide an additional commute option, consistent with providing multi-modal transit opportunities, which is one of the overarching goals of Brooklyn Basin.

In providing expanded service to Brooklyn Basin initially, the water taxi service would operate during the early morning and late afternoon commute hours 1 or 2 days per week, with additional days added as demand increases and as circumstances warrant. From Brooklyn Basin, the departure location would be from the Brooklyn Basin Marina, with a specific water taxi landing dock designed with service to the San Francisco Ferry building's Gate B. No modifications to the proposed marina layout would be required to accommodate the water taxi in the initial expansion stages. However, as demand may warrant a construction of separate dock designed to accommodate passenger loading and unloading utilizing the marina gangway and recent improvements to the main walk way.

3.5.1 *Overview of Initial Operations*

Service time. Assuming one morning and one evening run, the Brooklyn Basin service would operate approximately 3.5 hours per day; however, service will be available for non-commuter services outside commuter hours. The frequency of additional runs will be added as demand warrants including the number of days of operation and increasing the number of hours proportionally. The early phases of Water Taxi Service within Brooklyn Basin will accommodate passenger loading and unloading from an end tie slip within the first phase of the marina thereby

utilizing planned marina improvements without specialized improvements for exclusive water taxi uses.

Payment for service. Passengers would have the option to purchase and reserve seats on the operator's website as well as a potential community or transportation demand management services portal. Passengers would also be able to pay fares onboard. It is anticipated that advance sales of daily, weekly, and monthly passes would be available to residents of Brooklyn Basin.

3.5.2 Expansion of Service

As demand increases, it is anticipated that the initial service operating 1 to 2 days per week, two runs per day (morning and evening commute hours) would evolve to service 5 days a week with up to three trips each direction in the morning and evening commute periods. Depending on demand, the water taxi transit service may include service to locations such as San Francisco Pier 1.5, San Francisco Pier 40, San Francisco Pier 52, Pier 15 (New) Hyde Street Pier and areas near Crissy Field in San Francisco and may include East Bay stops at Jack London Square, Berkeley Marina, Alameda, and Richmond. Weekend service is not initially envisioned; however, if demand warrants, the water taxi service is capable of providing on demand weekend service, operating at times and frequency to accommodate the non-commute rider.

It should be noted that it is likely that the demand metrics for water taxi service would be directly proportional to the residential build-out of Brooklyn Basin.

Common Carrier Service

In the earlier stages of providing water taxi service to Brooklyn Basin it will be classified as an "on-demand" provider. Transitioning from an on-demand service to a common carrier service which enables the water taxi service to accommodate walk-on passengers and widely disseminate a robust commuter schedule, the water taxi operator will require amending their current CPUC license to include Brooklyn Basin (Tideline holds a CPUC Ferry license and on-demand certificate, and as such an amendment it is a much easier process than acquiring the license itself.) The envisioned water taxi operator, Tideline Marine Group (TMG), currently operates as a CPUC approved common carrier ferry operator from Berkeley Marina to and from San Francisco. In the case of TMG providing common carrier water taxi operations from Brooklyn Basin, an amendment to their current license with CPUC, as a ferry operator, for an expansion of services to include Brooklyn Basin accessing landing locations throughout the Bay. It should be noted that all Tideline vessels are ADA certified.

Future Improvements

As demand increases for water taxi service a separate passenger loading and unloading dock may be necessary. In the event that it is determined necessary it would utilize the entry gates, gangways and

mainwalk of the marina improvements with a dock dedicated for water taxi passenger loading and unloading constructed in the future.

3.6 Other Improvements

No upland work, dredging, or fill (other than installation of 162 piles) is proposed as part of this project. However, shoreline improvements under the separate and already approved Brooklyn Basin Mixed-Use Development (not under the scope of the proposed marina project) include significant enhancements to public access along the waterfront adjacent to the future Brooklyn Basin Marina. Upland improvements include constructing a publicly-accessible park and promenade along the shoreline of Clinton Basin. Shoreline reconfiguration and protection measures are also proposed; these include installing rock slope and improving bulkhead walls, as well as restoring shoreline marshland and vegetated embankments in select locations. Additionally, specific to the Ninth Avenue Terminal wharf, approximately 134,000 square feet of the deck and supporting piles below the mudline would be removed, and the remaining wharf would be seismically upgraded. New landside facilities would include a harbormaster office, showers and laundry facilities, and boater parking in compliance with the Clean Marina Program. Marina restroom facilities would also be located on the ground floor of a building along Clinton Basin's eastern shoreline (near Docks M1 and M2), as well as a building along Clinton Basin's western shoreline (near Dock L).

Permits have been secured from the appropriate regulatory agencies to permit the construction of the Brooklyn Basin Project shoreline improvements. The sequence of constructing the phased Brooklyn Basin Project shoreline improvements will precede completion of the proposed project's phased marina improvements to ensure convenient pedestrian access is afforded to the open space improvements and marina.

3.7 Schedule

The new marina would be constructed in five phases over a period of approximately 5 years, following approval of all entitlements, and in unison with Brooklyn Basin Project shoreline improvements (Figure 2). In-water work would only occur within the June 1 to November 30 environmental work window. The anticipated schedule is shown in Table 4.

Table 4
Construction Schedule

Phase	Docks	Year to Commence
I	A, B, and C (40 slips)	2018-19
II	D, E, and F (64 slips)	2019-20
III	G, H, I, J, and K (64 slips)	2020-21
IV	M1 and M2 (43 slips)	2021-22
V	L1 (10 slips) and long dock	2022-23

3.8 Staging

It is anticipated that a 50-foot by 200-foot staging area would support project construction. On-site construction staging may include, among other items, temporary construction fencing and signage.

The new dock materials would be prefabricated at the dock manufacturer’s production facility and delivered by trucks to the on-site staging area. The new dock materials would be offloaded and placed into the water using a landside crane and then assembled in the water. The landside crane would be mobilized to the site on an as-needed basis for each phase of marina development.

4 Biological Resources

This section assesses potential project impacts to state and federal Endangered Species Act (ESA)-listed species regulated by the U.S. Fish and Wildlife Service (USFWS), National Marine Fisheries Service (NMFS), or California Department of Fish and Wildlife (CDFW), in addition to any critical habitat and Essential Fish Habitat (EFH) present in the project area. This assessment is limited to potential impacts from the Brooklyn Basin Marina project; impacts from upland Brooklyn Basin components are assessed in the 2006 *Oak to Ninth Avenue Project Final Environmental Impact Report* (2006 EIR; ESA 2006). Special status species and habitats affected by construction and operation of the Brooklyn Basin Marina are limited to those associated with aquatic and shoreline habitats (described in Section 2). These species and habitats are described in the following section, followed by an assessment of potential project impacts.

4.1 Special Status Species and Habitats in the Project Area

State and federally listed special status species, critical habitat, and EFH occurring or potentially occurring within the project area were identified from the following sources:

- Species observation records in the California Natural Diversity Database (CNDDDB) for the 7.5-minute U.S. Geological Service quadrangle (quad) containing the project area (Oakland West), as well as the eight adjacent quads, including San Quentin, Richmond, Briones Valley, Oakland East, San Leandro, Hunters Point, San Francisco South, and San Francisco North (CDFW 2017)
- NMFS's EFH Mapper (NMFS 2017)
- CDFW eelgrass distribution maps (CDFW 2016)

4.1.1 *ESA-listed Species*

Table 5 lists marine or shoreline species with recorded occurrences of inhabiting the vicinity of the study area listed as threatened or endangered pursuant to the federal ESA or listed as rare, threatened, or endangered pursuant to the California Endangered Species Act (CESA). Several marine species may be reasonably expected to inhabit the study area based on the presence of suitable habitat. ESA and CESA species with a moderate to high potential to inhabit the project area are discussed in further detail as follows, including a description of any associated critical habitat.

Table 5**Federal ESA- and State ESA-Listed Marine or Shoreline Species with the Potential to Inhabit the Study Area**

Species	Federal	State	Habitat Association	Potential to Inhabit
Fish				
Green sturgeon southern DPS (<i>Acipenser medirostris</i>)	T	SSC	Marine and estuarine environments and Sacramento River; all of the Bay-Delta	High potential to inhabit. Known to inhabit the Central Bay. Critical habitat present in the study area.
Tidewater goby (<i>Eucyclogobius newberryi</i>)	E	SSC	Brackish water habitats along the California coast from Agua Hedionda Lagoon, San Diego County to the mouth of the Smith River	No suitable habitat present. Species presumed to be extirpated from the Bay-Delta.
Delta smelt (<i>Hypomesus transpacificus</i>)	T	E	Sacramento-San Joaquin Delta, Suisun Bay, San Pablo Bay, river channels and sloughs in the Bay-Delta	Outside known range.
Hardhead (<i>Mylopharodon conocephalus</i>)	-	SSC	Low to mid-elevation streams in the Sacramento-San Joaquin drainage. Also present in the Russian River.	No suitable habitat present.
Central California coast ESU coho salmon (<i>Oncorhynchus kisutch</i>)	E	E	Ocean waters, Sacramento and San Joaquin Rivers; migrates from ocean through the Bay-Delta to freshwater spawning grounds	Low potential to occur. Known to migrate through Central Bay.
Central California coast DPS steelhead trout (<i>Oncorhynchus mykiss</i>)	T	-	Ocean waters, Sacramento and San Joaquin Rivers; migrates from ocean through the Bay-Delta to freshwater spawning grounds	Low to moderate potential to occur. Known to migrate through Central Bay. No critical habitat present in the study area, but ferry taxi crossing bay may traverse critical habitat (narrow channel of critical habitat out to Bay).
Central Valley DPS steelhead trout (<i>Oncorhynchus mykiss</i>)	T	-	Ocean waters, Sacramento and San Joaquin Rivers; migrates from ocean through the Bay--Delta to freshwater spawning grounds	Low potential to occur. Known to migrate through Central Bay.

Species	Federal	State	Habitat Association	Potential to Inhabit
Sacramento River winter-run ESU Chinook salmon (<i>Oncorhynchus tshawytscha</i>)	E	E	Ocean waters, Sacramento and San Joaquin Rivers; migrates from ocean through the Bay-Delta to freshwater spawning grounds	Low to moderate potential to occur. Known to migrate through the Central Bay. No critical habitat present in the study area, but ferry taxi crossing bay may traverse critical habitat (Bay north of Bay Bridge).
Central Valley spring-run ESU Chinook salmon (<i>Oncorhynchus tshawytscha</i>)	T	T	Ocean waters, Sacramento and San Joaquin Rivers; migrates from ocean through the Bay-Delta to freshwater spawning grounds	Low potential to occur. Known to migrate through Central Bay.
Central Valley fall-run/late fall-run Chinook salmon (<i>Oncorhynchus tshawytscha</i>)	-	SSC	Ocean waters, Sacramento and San Joaquin Rivers; migrates from ocean through the Bay-Delta to freshwater spawning grounds	Low potential to occur. Known to migrate through Central Bay.
Longfin smelt (<i>Spirinchus thaleichthys</i>)	C	T	Euryhaline, nektonic, and anadromous. Found in open waters of estuaries, mostly in middle or bottom of water column.	High potential to inhabit. Known to inhabit Central Bay.
Eulachon (<i>Thaleichthys pacificus</i>)	T	-	Klamath/North coast flowing waters.	Outside known range.
Marine Mammals				
Southern sea otter (<i>Enhydra lutris nereis</i>)	T	SSC	Protected deepwater coastal communities. Needs canopies of giant kelp and bull kelp for rafting and feeding. Prefers rocky substrates with abundant invertebrates.	Will not inhabit Project footprint. Single recorded occurrence in San Francisco Bay near Golden Gate inlet.
Humpback whale (<i>Megoptera noveangliae</i>)	E	-	Predominantly coastal waters, although occasional individuals enter the Bay-Delta.	Will not inhabit Project footprint. Infrequent transient visitor to the Bay, typically only in deeper waters.
Shore Birds				
Western snowy plover (<i>Charadrius alexandrinus nivosus</i>)	T	SSC	Flat, open coastal beaches, dunes, and near stream mouths.	Low to moderate potential to occur as transitory visitor. No breeding habitat present.
Saltmarsh common yellowthroat (<i>Geothlypis trichas sinuosa</i>)	-	SSC	Resident of the San Francisco Bay region, in fresh and salt water marshes.	Low to moderate potential to occur as transitory visitor. No breeding habitat present.

Species	Federal	State	Habitat Association	Potential to Inhabit
Ridgway's rail (<i>Rallus longirostris obsoletus</i>)	E	E; FP	Saltmarshes along San Francisco Bay.	Low to moderate potential to occur as transitory visitor. No breeding habitat present.
California least tern (<i>Sternula antillarum brownii</i>)	E	E; FP	Shallow estuaries and lagoons.	Low to moderate potential to occur as transitory visitor. No breeding habitat present.
California black rail (<i>Laterallus jamaicensis coturniculus</i>)	-	T	Freshwater marshes, wet meadows, and shallow margins of saltwater marshes bordering larger bays.	Low to moderate potential to occur as transitory visitor. No breeding habitat present.
Suisun song sparrow (<i>Melospiza melodia pusillula</i>)	-	SSC	Resident of brackish-water marshes surrounding Suisun Bay.	No potential to occur. Habitat not present and outside known range.
Alameda song sparrow (<i>Melospiza melodia pusillula</i>)	-	SSC	Resident of salt marshes bordering south arm of San Francisco Bay.	Low to moderate potential to occur as transitory visitor. No breeding habitat present.
San Pablo (<i>Melospiza melodia samuelis</i>)	-	SSC	Resident of salt marshes along the north side of San Francisco and San Pablo bays.	No potential to occur. Habitat not present and outside known range.

Notes:

Bay-Delta: San Francisco Bay-Delta

DPS: distinct population segment

E: endangered

ESU: evolutionarily significant unit

FSC: federal species of special concern

SSC: state species of special concern

T: threatened

Sources:

CDFW (California Department of Fish and Wildlife), 2017. California Natural Diversity Database (CNDDDB) and U.S. Fish and Wildlife Service database search of Project and surrounding quadrangles; Oakland West quad), as well as the eight adjacent quads, including San Quentin, Richmond, Briones Valley, Oakland East, San Leandro, Hunters Point, San Francisco South, and San Francisco North.

NMFS (National Marine Fisheries Service), 2001. Fisheries Management Plan Species Distributions in San Francisco, San Pablo and Suisun Bays. Accessed September 1, 2013. Available from: <http://swr.nmfs.noaa.gov/hcd/loclist.htm>.

URS (URS Corporation), 2003. *Final Program Environmental Impact Report Expansion of Ferry Transit Service in the San Francisco Bay Area*. Prepared for the Water Transit Authority. June 2003.

4.1.1.1 Chinook Salmon

Three Chinook salmon evolutionarily significant units (ESUs) migrate through the northern and central portions of the Bay: Sacramento River winter-run, Central Valley spring-run, and Central Valley fall/late fall-run (CDFG 1987). Each ESU is considered a distinct race and has been given its own management status: the Sacramento River ESU is state and federally listed as endangered; the Central Valley spring-run is federally and state listed as threatened; and the Central Valley fall/late fall-run is a state and federal species of special concern (CDFW 2013).

Sacramento River winter-run Chinook salmon migrate and spawn from mid-December to August along the Sacramento River, up to Keswick Dam in Shasta County. Adult winter-run Chinook salmon can be found in the Bay in November and December. Central Valley spring-run Chinook salmon have a similar life history, but begin spawning migration to the Delta in late winter to spring. Adults are found in the Bay during the migratory period in the spring, and juveniles have the potential to inhabit the Bay in the fall, winter, and spring. Adult Central Valley fall-run/late fall-run Chinook salmon begin their migration toward their spawning grounds in June, with a peak in September. They spawn in the Delta in December and January.

Critical habitat for Sacramento River winter-run Chinook includes all waters of the Bay north of the Bay Bridge (Federal Register Vol. 58 No. 114). While this critical habitat area is outside the Brooklyn Basin project area, the proposed water taxi route may traverse critical habitat. The project site (including water taxi routes) is outside of any critical habitat for Central Valley spring-run Chinook salmon (Federal Register Vol. 70 No. 170), and there is no critical habitat designation for Central Valley fall-run/late fall-run Chinook.

4.1.1.2 Coho Salmon

Coho salmon are listed as threatened under ESA and endangered under CESA. Adult coho migrate through the Bay after late fall or winter heavy rains to spawn in the Delta. Juvenile coho potentially inhabit the Bay in the spring, summer, and fall and may be present in the Central Bay. The project site (including water taxi routes) is outside of Coho salmon critical habitat areas (Federal Register Vol. 64 No. 86).

4.1.1.3 Steelhead Trout

Individuals from two steelhead ESUs can be found in the Bay: central California coast steelhead and Central Valley steelhead. Both ESUs are federally listed as threatened, and central California coast steelhead are also a state species of special concern. Central Valley steelhead migrate between the ocean and the Delta and its tributaries via the San Francisco and San Pablo bays. Upstream migration occurs in the winter, with peak spawning occurring from December through April. Central California coast steelhead migrate from the Pacific coast through the Bay in the winter to spawn in freshwater in the upper Sacramento River. Critical habitat for central California coast steelhead includes a

narrow channel through the Central Bay out to the Pacific Ocean (Federal Register Vol. 70 No. 170). While this critical habitat area is outside the Brooklyn Basin project area, the proposed water taxi route may traverse this narrow corridor of critical habitat. The project site (including water taxi routes) is outside of Central Valley steelhead critical habitat areas (Federal Register Vol. 70 No. 170).

4.1.1.4 Green Sturgeon

Green sturgeon is listed as a federally threatened species and as a state species of concern. Green sturgeon are found throughout the Bay and are native to the Sacramento-San Joaquin River system. Spawning occurs in the lower reaches of the Sacramento-San Joaquin River system; however, feeding occurs throughout the Bay. Adult green sturgeon migrate into freshwater beginning in late February, with spawning occurring in March through July and peak activity in April and June. After spawning, juveniles remain in fresh and estuarine waters for 1 to 4 years and then begin to migrate out to sea. Critical habitat for green sturgeon occurs within the Central Bay and includes the study area (NMFS 2001), although they do not appear to be frequent or significant inhabitants (CDFW 2001).

4.1.1.5 Longfin Smelt

Longfin smelt are listed as a state threatened species. Longfin smelt live in open waters of the Central Bay, including within the study area (IEP 2005-2009). Longfin smelt inhabit Central Bay waters throughout the year, although they migrate to the Delta to spawn in freshwater during the winter. No critical habitat has been designated for this species.

4.1.1.6 ESA-listed Shorebirds

The project site and adjoining areas do not contain suitable breeding habitat for California clapper rail, California least tern, or Western snowy plover (ESA 2006). These species are unlikely to inhabit the project area, and any occurrences of these species in the project area would be transitory and incidental. Furthermore, there are no recorded occurrences of these species within the project area (CDFW 2017).

4.1.2 Marine Mammals

The two most likely species of marine mammals to occur in the Bay waters surrounding Clinton Basin and Brooklyn Basin are the harbor seal (*Phoca vitulina*) and the California sea lion (*Zalophus californianus*).

Pacific harbor seals are nonmigratory, have limited seasonal movements associated with foraging and breeding activities, and use the Bay year-round (Kopec and Harvey 1995). Harbor seals also use the Bay for foraging and resting. There are 12 haul-out (resting) sites and rookeries (nesting, breeding, and pupping areas) within the Bay, the closest of which is the Alameda Breakwater Gap, approximately 5 miles from the project area (ESA 2006).

California sea lions breed in Southern California and along the Channel Islands. After the breeding season, males migrate up the Pacific Coast and enter the Bay. During anchovy and herring runs, approximately 400 to 500 sea lions (mostly immature males) feed almost exclusively in the North and Central Bay and could occasionally forage in the project area (USFWS 1992).

Other marine mammal species which occasionally inhabit the Bay and may have a very low likelihood of occurrence at the project site as transient visitors include the gray whale (*Eschrichtius robustus*), harbor porpoise (*Phocoena phocoena*), northern elephant seal (*Mirounga angustirostris*), Steller sea lion (*Eumetopias jubatus*), northern fur seal (*Callorhinus ursinus*), and, less frequently, the southern sea otter (*Enhydra lutris*) (URS 2003). On rare occasions, individual humpback whales (*Megaptera novaeangliae*) have entered the Bay.

The project area also falls within designated critical habitat for the endangered Steller sea lion (*Eumetopias jubatus*), but this critical habitat zone covers almost the entire West Coast of the United States, including Alaska. Because the project area constitutes such a small portion of Stellar sea lion critical habitat and this species is rarely seen in the Bay, Stellar sea lion is highly unlikely to occur at the project site.

4.1.3 Migratory Bird Treaty Act Protected Birds and Raptors

Several species of birds protected by the Migratory Bird Treaty Act may occur in the project vicinity. The 2006 EIR (ESA 2006) identified double-crested cormorant and brown pelican as having moderate or high potential to occur within the project site shoreline, and Cooper's hawks may be present in ornamental trees in the project vicinity. Although the shoreline in the project area is developed, brown pelicans or other Migratory Bird Treaty Act (MBTA)-protected shorebirds could roost on the dock, pier, and shoreline areas within the project site (ESA 2006). Other species protected by the MBTA may also occur in the project area, potentially including nesting populations.

4.1.4 Eelgrass

Eelgrass has been afforded special management considerations by CDFW, USFWS, NMFS, the U.S. Environmental Protection Agency, BCDC, and the Golden Gate Audubon Society. NMFS considers eelgrass beds to be a habitat area of particular concern. Eelgrass commonly inhabits shallow, soft-bottom substrates of bays and estuaries throughout the California coast. Eelgrass beds often accrete sediments and function ecologically as substrate for epifauna and nursery habitat for juvenile fish. In the Bay, eelgrass provides unique biological environments for spawning Pacific herring, and serves as a nursery area for many valued species of fish, including Pacific herring, halibut (*Hippoglossus* spp.), and English sole.

Per CDFW eelgrass maps for the Bay, eelgrass has not been recorded within the project area (CDFW 2016). The nearest recorded eelgrass populations were observed on the south shoreline of Alameda

Island (approximately 2 miles south) and across from Oakland International Container Terminal Berth 56 (approximately 3.4 miles west).

4.1.5 Essential Fish Habitat

The project site is located within the Central Bay subregion of the Bay, and is therefore within designated EFH for assorted fish species managed under the Coastal Pelagic, Pacific Groundfish, and Pacific Coast Salmon Fishery Management Plans (FMPs; NMFS 2001). The Pacific Coast Groundfish FMP manages at least 89 species over a large, ecologically diverse area covering the entire West Coast of the continental United States; 15 species managed under this FMP have species distributions within the Central Bay. The Coastal Pelagic Species FMP includes five species, three of which have known species distributions in the Central Bay. In addition, the Pacific Coast Salmon FMP includes Chinook salmon and coho salmon, and identifies the entire Bay as EFH (NMFS 2001). Species for which EFH has been designated that are likely to exist in the study area are listed in Table 6.

Table 6
Species with Designated EFH within the Central San Francisco Bay

Common Name	Scientific Name
Pacific Groundfish FMP	
English sole	<i>Parophrys vetulus</i>
Starry flounder	<i>Platichthys stellatus</i>
Brown rockfish	<i>Sebastes auriculatus</i>
Pacific sanddab	<i>Citharichthys sordidus</i>
Lingcod	<i>Ophiodon elongatus</i>
Sand sole	<i>Psettichthys melanostictus</i>
Leopard shark	<i>Triakis semifasciata</i>
Spiny dogfish	<i>Squalus acanthias</i>
Big skate	<i>Raja</i> ssp.
Pacific whiting (hake)	<i>Merluccius productus</i>
Kelp greenling	<i>Hexagrammos decagrammus</i>
Soupfin shark	<i>Galeorhinus galeus</i>
Curlfin sole	<i>Pleuronichthys decurrens</i>
Bocaccio	<i>Sebastes paucispinis</i>
Cabazon	<i>Scorpaenichthys marmoratus</i>
Coastal Pelagic FMP	
Northern anchovy	<i>Engraulis mordax</i>
Jack mackerel	<i>Trachurus symmetricus</i>
Pacific sardine	<i>Sardinops sagax</i>

Common Name	Scientific Name
Pacific Coast Salmon FMP	
Chinook salmon	<i>Oncorhynchus tshawytscha</i>
Coho salmon	<i>Oncorhynchus kisutch</i>

Notes:

EFH: essential fish habitat

FMP: Fishery Management Plan

Source: NMFS (National Marine Fisheries Service), 2001. *Fisheries Management Plan Species Distributions in San Francisco, San Pablo and Suisun Bays*. Accessed September 1, 2013. Available from: <http://swr.nmfs.noaa.gov/hcd/loclist.htm>.

4.2 Potential Project Impacts

4.2.1 ESA-listed Fish Species

4.2.1.1 Turbidity and Suspended Sediments

Pile driving may temporarily disturb benthic sediments and increase suspended sediment levels in the immediate vicinity of the project site during construction. During construction, increased suspended sediment levels and associated loss of benthic or encrusting organisms may temporarily impact foraging opportunities. Temporary increases in suspended sediment may cause clogging of gills and feeding apparatuses of fish and filter feeders, if present; however, studies have shown that projects involving similar but larger-scale sediment and benthos disturbance (e.g., dredging) did not have long-term adverse effects on fish populations (Chambers Group 1998). In addition, the Bay has relatively high suspended sediment levels under baseline conditions (Jassby et al. 2002).

The project includes implementation of avoidance and minimization measures to reduce or eliminate potential impacts to biological resources (Section 5). This includes limiting pile driving to only occur from June 1 to November 30, during the salmonid work window. Project construction impacts related to turbidity and suspended sediments would therefore not affect any salmonid species. Based on the analysis presented above, green sturgeon and longfin smelt (year-round residents of the Bay) would experience only negligible effects related to turbidity and suspended sediments.

4.2.1.2 Underwater Noise

Underwater sound pressure generated by construction operations, including pile driving, may temporarily affect fish behavior. Limiting pile driving to the salmonid work window of June 1 to November 30 will ensure that salmonids are not adversely affected by underwater noise.

Comprehensive bioacoustics modeling was performed to identify project impact radiuses (both for injury and behavior effects) from pile driving, and to assess potential impacts to green sturgeon and longfin smelt that could potentially be in the project area during pile driving (Appendix B).

In brief, the potential risk of injury and mortality from pile driving to the few green sturgeon or longfin smelt that may be present is extremely low, and behavioral effects would be negligible. These conclusions are based on the small area of effect, the limited duration of construction, the availability of suitable habitat in surrounding areas, the mobility of green sturgeon and longfin smelt, and in consideration of avoidance and minimization measures proposed for the project (see Section 5). As an additional precaution, the applicant is proposing to use bubble curtains during pile driving activities to attenuate noise from the striking of steel piles.

4.2.1.3 Shading

Long-term overwater shading from docks and piers has historically been viewed as relatively neutral with respect to fish communities (NAVFACSW and Unified Port of San Diego 2011); seasonal variance would likely have a much stronger effect on fish community composition compared to relatively minor changes in light gradients from gangways and floats. The addition of artificial hard substrates may minimally increase habitat area for encrusting organisms on which fish feed. Shading effects to fish are therefore not expected to be adverse.

Based on agency input during the June 2017 agency meeting, the project proponent proposes purchasing credits from an approved mitigation or conservation bank. Additional information on mitigation is included in Section 6.

4.2.1.4 Vessel Operations

An increase of recreational marine traffic and implementation of water taxi operations could result in incrementally increased risk of entrainment and localized increases in turbidity from vessel wake; however, due to the minor increases in vessel traffic compared to existing conditions, and the naturally turbid conditions of the Bay, effects on fish are not expected to be adverse.

4.2.2 *Marine Mammals*

Pinnipeds, including California sea lions and harbor seals, may haulout on buoys near or within the project site, and there is a very low likelihood of occurrence of other marine mammal species as infrequent transient visitors. Project-related disturbance would be expected to have no more than a minor effect on individual animals' range and no effect on migration, breathing, nursing, breeding, feeding, sheltering, or populations of marine mammals.

Comprehensive bioacoustics modeling was performed to identify project impact radiuses (both for injury and behavior effects) from pile driving, and to assess potential impacts to marine mammals (Appendix B). In consideration of avoidance and minimization measures proposed for the project (including construction ramp-up procedures and construction monitoring; see Section 5), the limited duration of construction, the availability of suitable habitat in surrounding areas, and the mobility of marine mammals, pile driving is not anticipated to result in injury to marine mammals, and effects

experienced by individual marine mammals are anticipated to be limited to short-term disturbance of normal behavior or temporary displacement of animals near the noise source.

4.2.3 ESA-listed Shorebirds and Migratory Bird Treaty Act-protected Birds and Raptors

ESA-listed shorebirds would likely only be transitory visitors to the project site, as the project site does not provide suitable nesting habitat for these species. Pile driving may increase turbidity in the area immediately around the pier, which may affect shorebird foraging, although such impacts would likely be minimal, localized, and negligible in comparison with existing site conditions.

MBTA-protected birds and raptors may, however, nest in the project vicinity. Impacts to these species from construction may include nest failure or nest abandonment from construction noise and increased human presence in the area. The project includes implementation of avoidance and minimization measures designed to avoid impacts to MBTA-protected birds and raptors (Section 5). This includes construction timing to avoid the breeding season and preconstruction nesting bird surveys (if necessary). With implementation of these measures, the project is unlikely to adversely affect MBTA-protected birds and raptors.

4.2.4 Eelgrass

As previously described, eelgrass has not been recorded within the project area (CDFW 2016). Therefore, impacts to eelgrass from the project are not anticipated. If required during the permitting process, the applicant will perform an eelgrass pre-construction survey prior to construction. If eelgrass is encountered within the proposed construction footprint, a post-construction eelgrass survey would also be completed to assess impacts to eelgrass. All surveys and any potentially required mitigation would be completed per the California Eelgrass Mitigation Policy.

4.2.5 Essential Fish Habitat

Potential construction impacts on EFH would include the temporary removal of habitat that provides shelter and/or prey resources, minor increased suspended sediment levels and turbidity relative to background conditions, and behavioral disturbance due to increased underwater sound pressure levels. Permanent impacts would include increased shading and incrementally increased risk of entrainment and localized increases in turbidity from vessel wake. For species with designated EFH that may occur in the project area, these effects would be minimal and similar to those potentially experienced by ESA-listed fish species.

5 Avoidance and Minimization of Impacts

Potential impacts from the project's waterside activities are anticipated to be temporary and minimal. The following are several best management practices (BMPs) that would be implemented during construction to avoid or minimize impacts. The Water Quality Management Plan (Appendix C) describes BMPs to minimize water quality impacts pertaining from operation of the marina.

5.1 Protection of Water Quality during Construction

General BMPs are as follows:

- The contractor will fully understand and adhere to the terms and conditions of approvals and permits obtained, as well as all project BMPs.
- All construction activities will occur within the designated project footprint.

Water quality BMPs are as follows:

- Disturbance to the ocean bottom and intertidal areas will be minimized.
- Netting, sandbags, tarps, or other forms of barriers will be placed around staging areas to prevent debris from entering the water.
- All construction-related equipment will be inspected daily and maintained in good working order to minimize the potential for hazardous waste spills. Current hazardous material spill prevention and cleanup plans will be maintained on site. Hammers and other hydraulic attachments will be placed on plywood and covered with plastic or a comparable material prior to the onset of rain to prevent run-on and runoff.
- Floating booms will be maintained around the project site to capture floating debris. Divers would recover non-buoyant debris from the bay bottom within 72 hours of known condition. All debris and trash will be collected and disposed of in appropriate waste containers by the end of each construction day. Discharge of hazardous materials into the project site will be prohibited.
- Washout from concrete trucks will be disposed of at locations not subject to runoff. Disposal locations will be more than 50 feet away from all storm drains, open ditches, and surface waters.
- Following project completion, the project area will be inspected to ensure that no construction debris, trash, or materials remain and that the project has not created any hazards to navigation.
- All surface runoff from the parking lot or street will be collected and treated prior to being discharged into the storm drain system.
- The marina will provide a waste disposal station for collecting and handling waste oil, trash, and batteries.

EFH and special status species BMPs are as follows:

- The applicant will obtain and comply with all required resource agency permit conditions, including any required work windows.
- Pile driving will only occur from June 1 to November 30, during the salmonid work window.
- The contractor will conduct a visual scan before commencing any pile-driving operations to ensure no mammals are within the immediate vicinity of pile hammering and will employ “soft start” techniques for any impact pile driving.
- The applicant will implement a bubble curtain during pile driving activities to attenuate noise from the striking of steel piles.
- To the extent feasible, construction activities will be conducted outside the breeding season for birds and raptors (August 1 through January 30). If seasonal avoidance is infeasible, the following measures will be required to avoid potential adverse effects on nesting special status raptors and other nesting birds:
 - A qualified wildlife biologist will conduct preconstruction surveys of all potential nesting habitat within 500 feet of construction activities. Preconstruction surveys should occur no later than 2 weeks prior to the start of construction activities.
 - If active nests of raptors or other bird species are found during preconstruction surveys, a no-disturbance buffer zone will be created around active nests during the breeding season or until a qualified biologist determines that all young have fledged. The size of the buffer zones and types of construction will be determined in consultation with CDFW and will be based on existing noise and human disturbance levels at the project site.
 - If preconstruction surveys indicate that nests are inactive or potential habitat is unoccupied during the construction period, no further avoidance measures would be implemented.

6 Mitigation

As described previously, current shading by solid fill in the project area can be attributed to the existing unusable marina in Clinton Basin, which spans approximately 28,150 square feet. Following installation of the new marina (which would include removal of the existing marina in Clinton Basin), the project would increase shading by solid fill by approximately 86,225 square feet.

To offset unavoidable impacts resulting from an increase in solid fill, the project proponent proposes purchasing credits from an approved mitigation or conservation bank. The final number of credits will be determined in coordination with the resource and regulatory agencies during the permitting process.

7 References

- CDFG (California Department of Fish and Game), 1987. *Delta Outflow Effects on the Abundance and Distribution of San Francisco Bay Fishes and Invertebrates, 1980-1985*. Exhibit 60. Prepared by CDFG for the State Water Resources Control Board 1987 Water Quality/Water Rights Proceedings on the San Francisco Bay/Sacramento-San Joaquin Delta. Interagency Ecological Study Program for the Sacramento-San Joaquin Estuary, Sacramento, California
- CDFW (California Department of Fish and Wildlife), 2001. Green Sturgeon. In *California's Living Marine Resources: A Status Report*. December 2001.
- CDFW (California Department of Fish and Wildlife), 2013. CDFW Resource Management Entry for Chinook Salmon.
- CDFW (California Department of Fish and Wildlife), 2016. CDFW BIOS Viewer Eelgrass Dataset. Last update May 4, 2016, with San Francisco Bay data from Merkel & Associates (2014).
- CDFW (California Department of Fish and Wildlife), 2017. California Natural Diversity Database (CNDDDB) and U.S. Fish and Wildlife Service database search of Project and surrounding quadrangles: San Francisco North, San Rafael, San Quentin, Richmond, Point Bonita, Oakland West, Hunters Point, and San Francisco South.
- Chambers Group, 1998. *Preliminary Draft Dredge Material Management Plan Programmatic Environmental Impact Statement/Report for Harbors/Marinas in the Los Angeles Region*. Prepared for the U.S. Army Corps of Engineers, Los Angeles District. September 1998.
- ESA (Environmental Science Associates), 2006. *Oak to Ninth Avenue Project Final Environmental Impact Report*. State Clearinghouse No. 2004062013. Prepared for the City of Oakland Community and Economic Development Agency. February 2006. Available from: <http://www2.oaklandnet.com/oakca1/groups/ceda/documents/webcontent/oak035552.pdf>.
- IEP (Interagency Ecological Program for the San Francisco Bay Estuary), 2005-2009. San Francisco Bay Study unpublished raw midwater trawl data and unpublished raw bottom trawl data, 2005-2009.
- Jassby, A. D., J. E. Cloern, and B. E. Cole, 2002. Annual primary production: Patterns and mechanisms of change in a nutrient-rich tidal ecosystem. *Limnology and Oceanography* 47(3):698-712. Available from: http://aslo.org/lo/toc/vol_47/issue_3/0698.pdf
- Kopec, D. and J. Harvey, 1995. *Toxic Pollutants, Health Indices, and Pollution Dynamics of Harbor Seals in San Francisco Bay, 1989-91, Final Report*. Moss Landing Marine Labs, Moss Landing, California.

NAVFACSW (Naval Facilities Engineering Command) and Unified Port of San Diego, 2011. *San Diego Bay Integrated Natural Resources Management Plan, Draft*. Prepared by Tierra Data, Inc., Escondido, California. November 2011.

NMFS (National Marine Fisheries Service), 2001. *Fisheries Management Plan Species Distributions in San Francisco, San Pablo and Suisun Bays*.

NMFS, 2017. Essential Fish Habitat Mapper. Available from: <http://www.habitat.noaa.gov/protection/efh/efhmapper/>

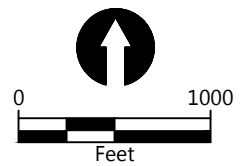
PWA (Philip Williams & Associates, Ltd.), 2001. *Former Seabreeze Yacht Harbor-Wetland Enhancement Project*. Prepared for the State of California Coastal Conservancy and Port of Oakland. August 2, 2001.

URS (URS Corporation), 2003. *Final Program Environmental Impact Report Expansion of Ferry Transit Service in the San Francisco Bay Area*. Prepared for the Water Transit Authority. June 2003.

USFWS (U.S. Fish and Wildlife Service), 1992. *Status and Trends Report on Wildlife of the San Francisco Estuary*. Prepared under U.S. Environmental Protection Agency cooperative agreement CE-009519-0. Sacramento, California. January 1992.



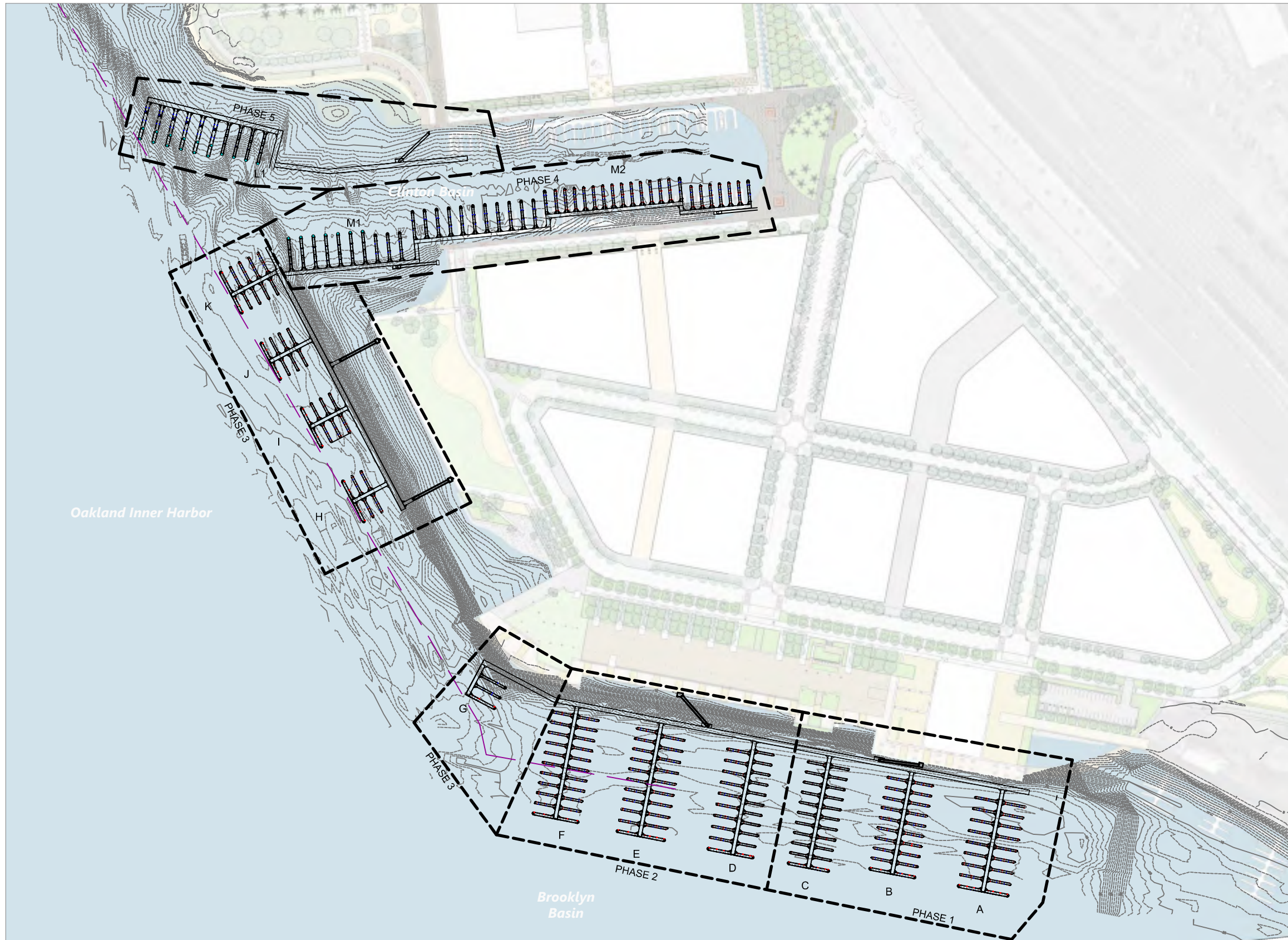
AERIAL SOURCE: Google Earth Pro, 2016.
HORIZONTAL DATUM: California State Plane, Zone 3,
 NAD83, U.S. Feet.






Publish Date: 2017/07/13 11:29 AM | User: mpratschner
 Filepath: L:\AutoCAD Project Files_Projects\1166-Signature Development\Signature\Brooklyn Basin Marina\1166 RP 004 VIC MAP.dwg AQ-A-Portrait

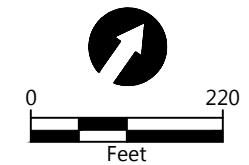


Figure 1
Vicinity Map
 Brooklyn Basin Development Project



LEGEND:

-  Proposed Docks
-  Proposed Tree
-  Proposed Bioretention Area

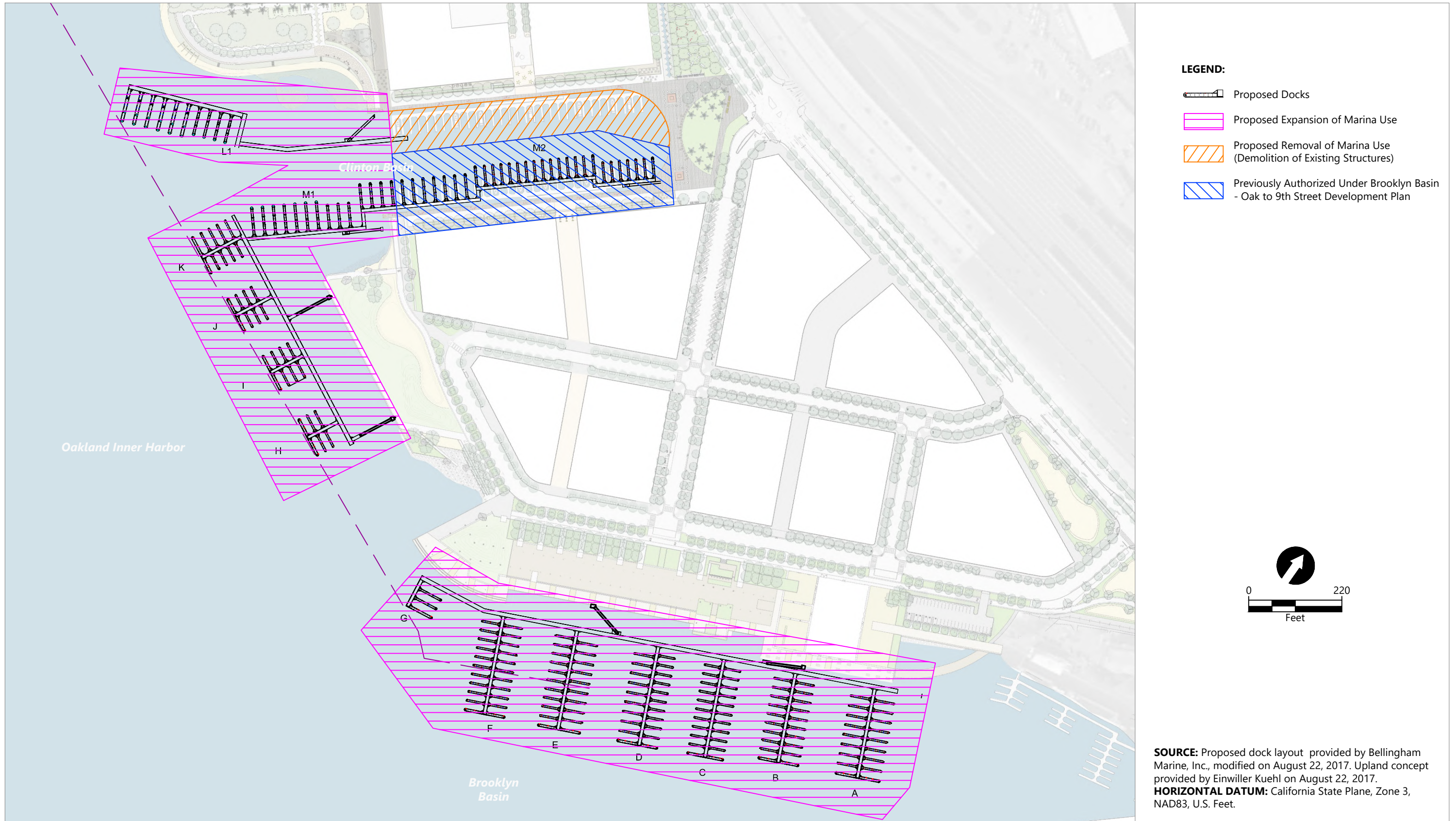


SOURCE: Proposed dock layout provided by Bellingham Marine, Inc., modified on August 22, 2017. Upland concept provided by Einwiller Kuehl on August 22, 2017.
HORIZONTAL DATUM: California State Plane, Zone 3, NAD83, U.S. Feet.

Publish Date: 2017/09/18 11:59 AM | User: mpratschner
 Filepath: K:\Projects\1166-Signature Development\Signature\Brooklyn Basin Marina\1166-RP-005 DOCKS (8-22-2017).dwg FIG 2



Figure 2
Revised Dock Layout
 Brooklyn Basin Development Project

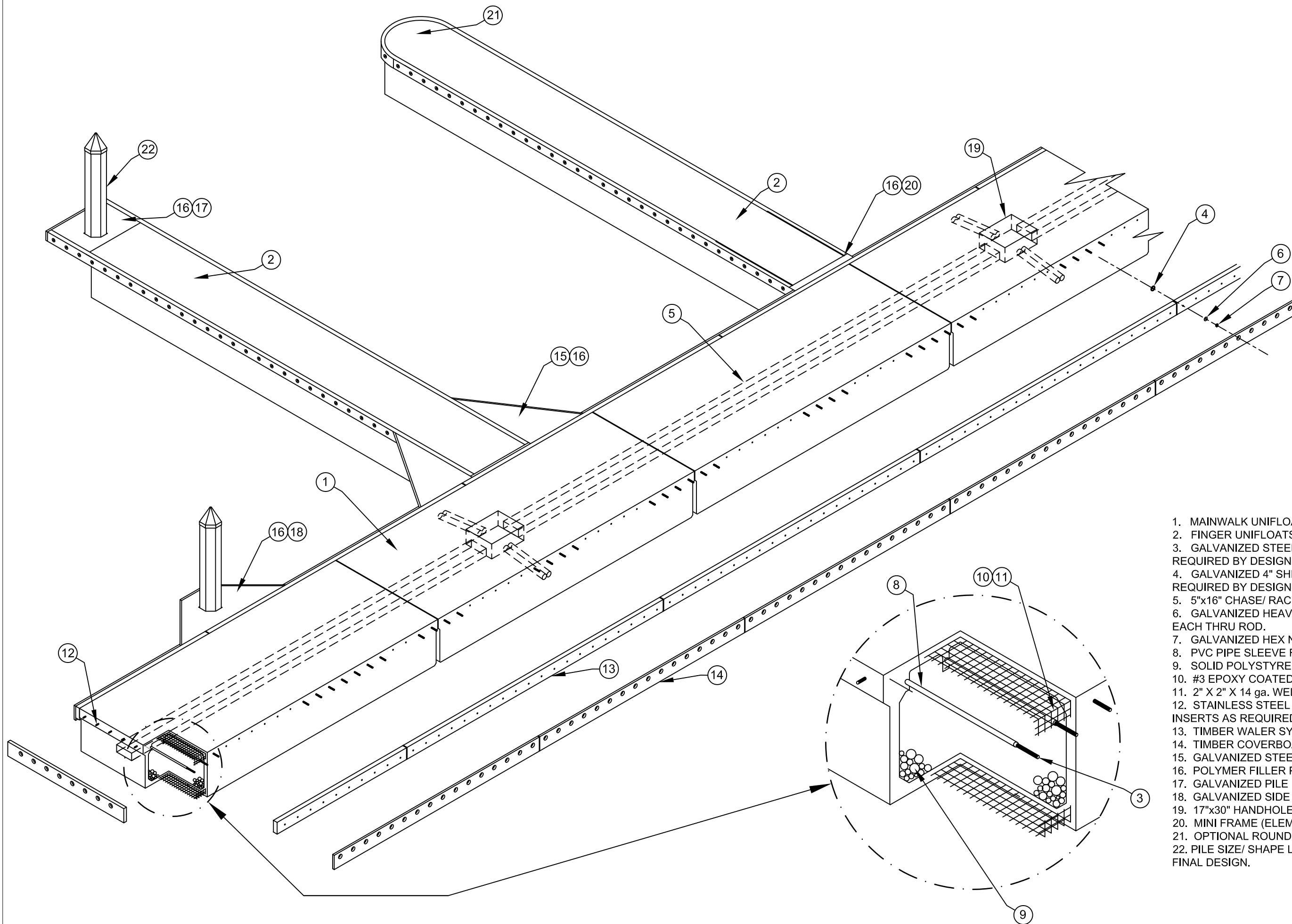


Publish Date: 2018/01/19 4:23 PM | User: rpetrie
 Filepath: K:\Projects\1166-Signature Development\Signature\Brooklyn Basin Marina\1166-RP-006 DOCKS (1-12-2018).dwg FIG 3

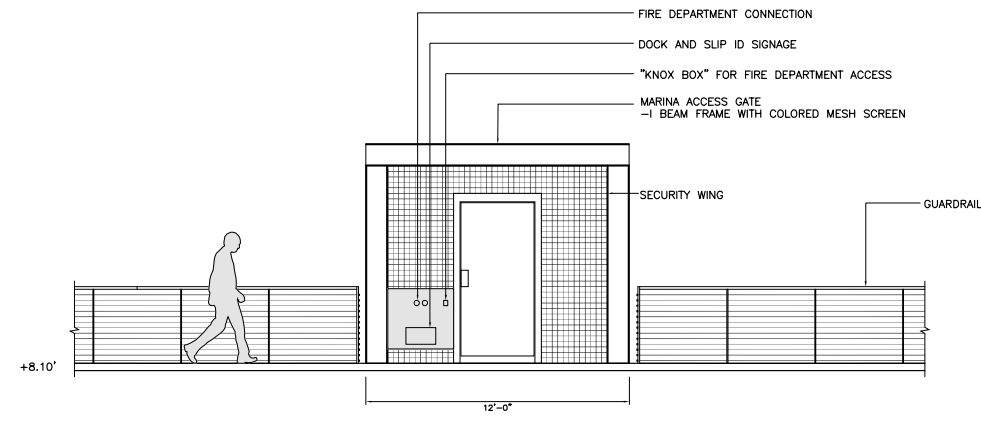


Figure 3
Proposed and Previously Approved Dock Layout Details
 Brooklyn Basin Development Project

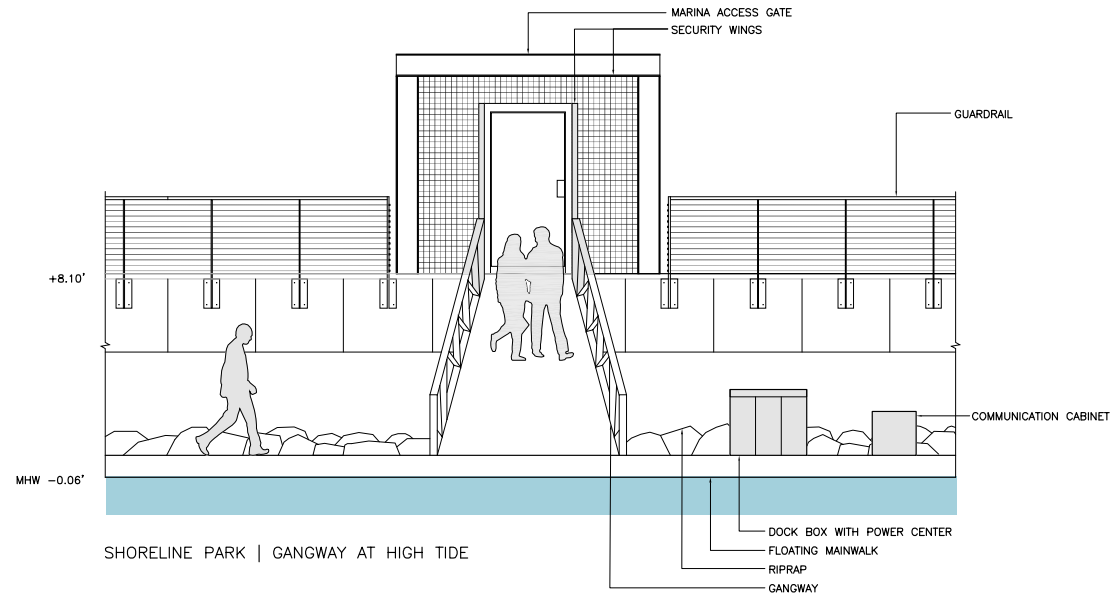
This drawing contains proprietary information which is the property of Bellingham Marine Industries, Inc., and shall not be copied, reproduced or made available to third parties without prior written permission from Bellingham Marine Industries, Inc. UNIFLOAT® and UNIDECK® and © Bellingham Marine Industries, Inc.



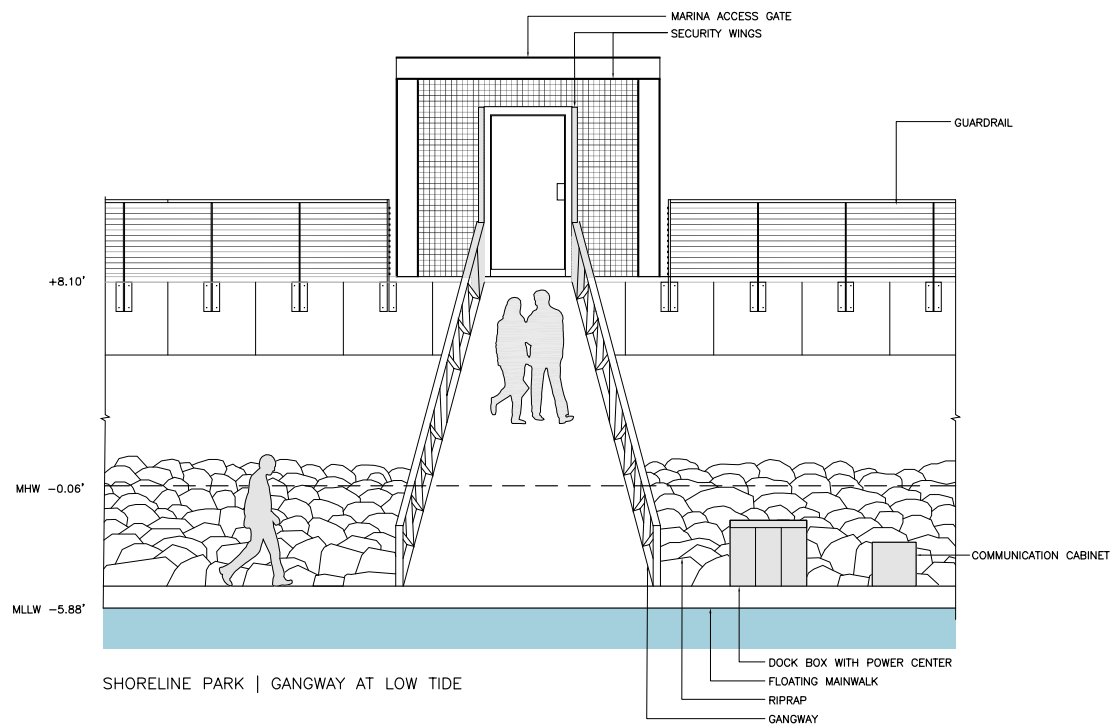
1. MAINWALK UNIFLOATS IN 10 TO 20' LENGTHS.
2. FINGER UNIFLOATS, SINGLE PIECE UP TO 50' IN LENGTH.
3. GALVANIZED STEEL THRU RODS 3/4"Ø, QUANTITY AS REQUIRED BY DESIGN.
4. GALVANIZED 4" SHEAR PLATES AND/ OR SPLIT RINGS AS REQUIRED BY DESIGN.
5. 5"x16" CHASE/ RACEWAY.
6. GALVANIZED HEAVY DUTY FLAT WASHER TYPICAL @ EACH THRU ROD.
7. GALVANIZED HEX NUT TYPICAL @ EACH THRU ROD.
8. PVC PIPE SLEEVE FOR THRU ROD.
9. SOLID POLYSTYRENE CORE.
10. #3 EPOXY COATED REBAR AS REQUIRED BY DESIGN.
11. 2" X 2" X 14 ga. WELDED WIRE MESH, GALVANIZED.
12. STAINLESS STEEL 3/4"Ø STUDS W/ FERRULE LOOP INSERTS AS REQUIRED.
13. TIMBER WALER SYSTEM, SIZED BY DESIGN.
14. TIMBER COVERBOARD.
15. GALVANIZED STEEL WELDMENTS.
16. POLYMER FILLER PANEL.
17. GALVANIZED PILE GUIDE W/ UHMW RUB PADS.
18. GALVANIZED SIDE PILE GUIDE FOR PILES.
19. 17"x30" HANDHOLE/ PULLBOX.
20. MINI FRAME (ELEMİNATES TRI-FRAMES).
21. OPTIONAL ROUNDED FINGER END.
22. PILE SIZE/ SHAPE LOCATION TO BE DETERMINED IN FINAL DESIGN.



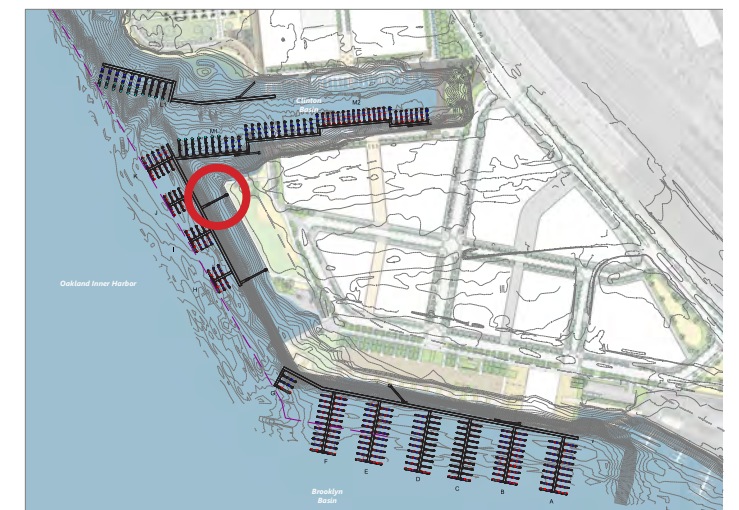
SHORELINE PARK | MARINA ENTRY GATE AT PUBLIC PARK



SHORELINE PARK | GANGWAY AT HIGH TIDE



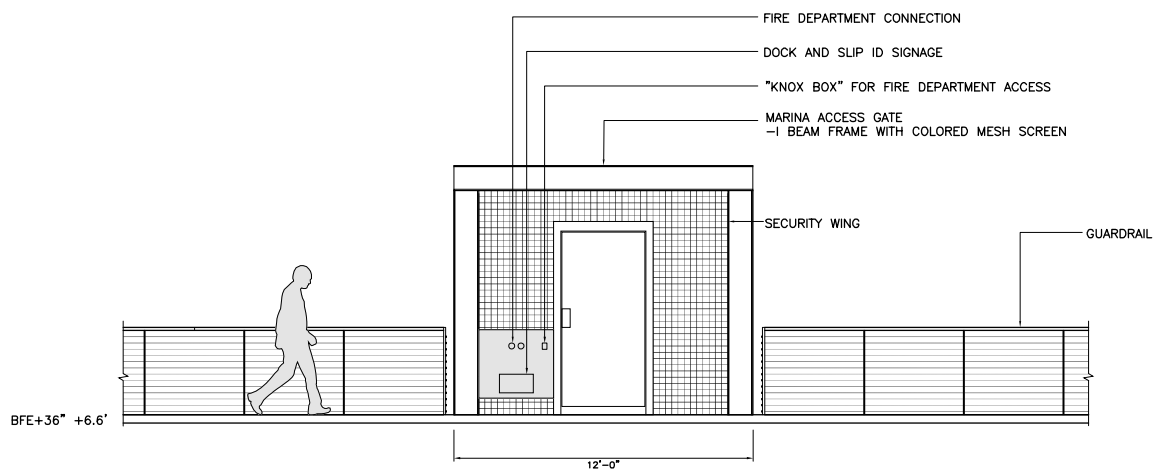
SHORELINE PARK | GANGWAY AT LOW TIDE



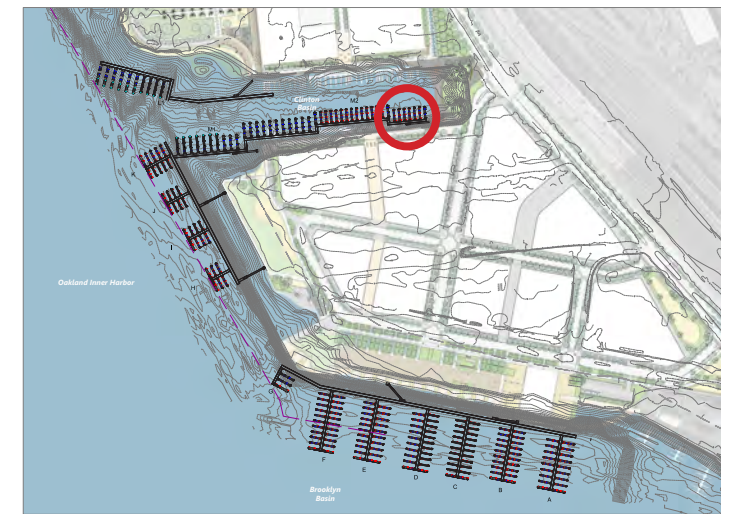
KEY PLAN

SHORELINE PARK MARINA ACCESS

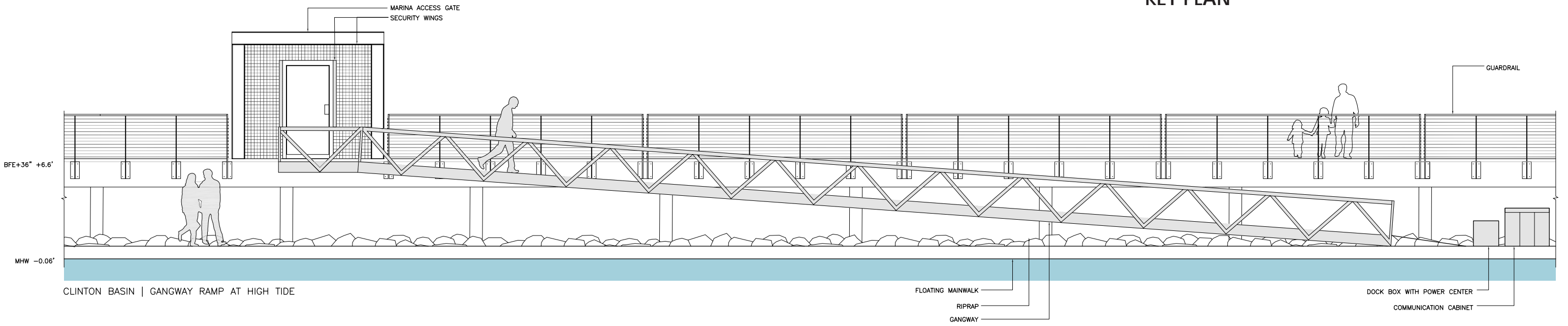
SCALE 1" = 8'



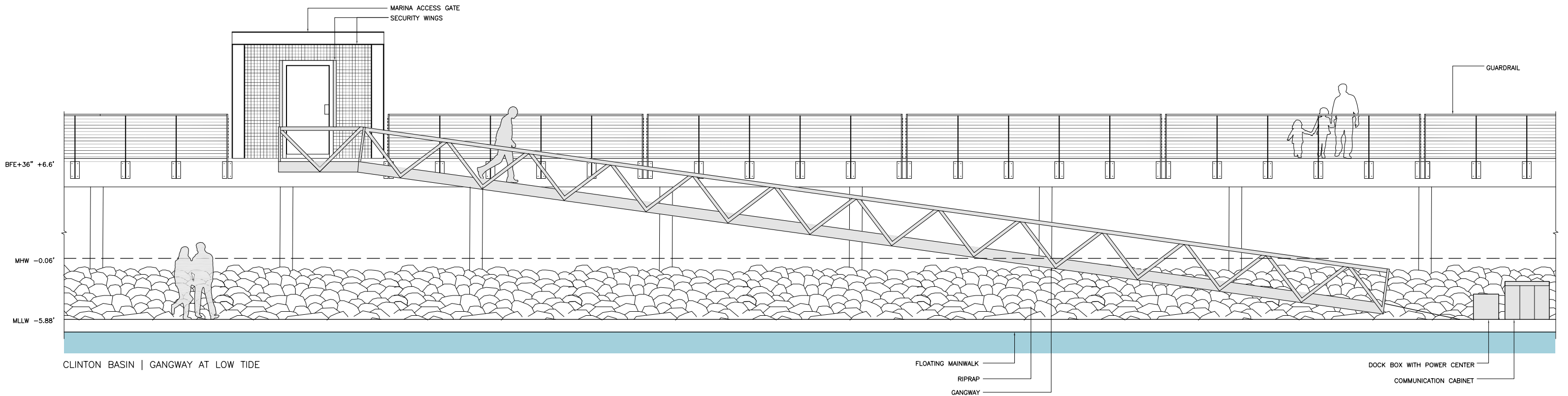
CLINTON BASIN | MARINA ENTRY GATE AT PUBLIC PARK



KEY PLAN



CLINTON BASIN | GANGWAY RAMP AT HIGH TIDE



CLINTON BASIN | GANGWAY AT LOW TIDE

CLINTON BASIN MARINA ACCESS

SCALE 1"=8'



white fire hose cabinet

piling with pile cap

pier for gangway access and to support gangway

power pedestal

dock box

mainwalk

gangway

finger

wood walers

cleat

mainwalk pile

cleat

finger end pile

fire hose cabinet

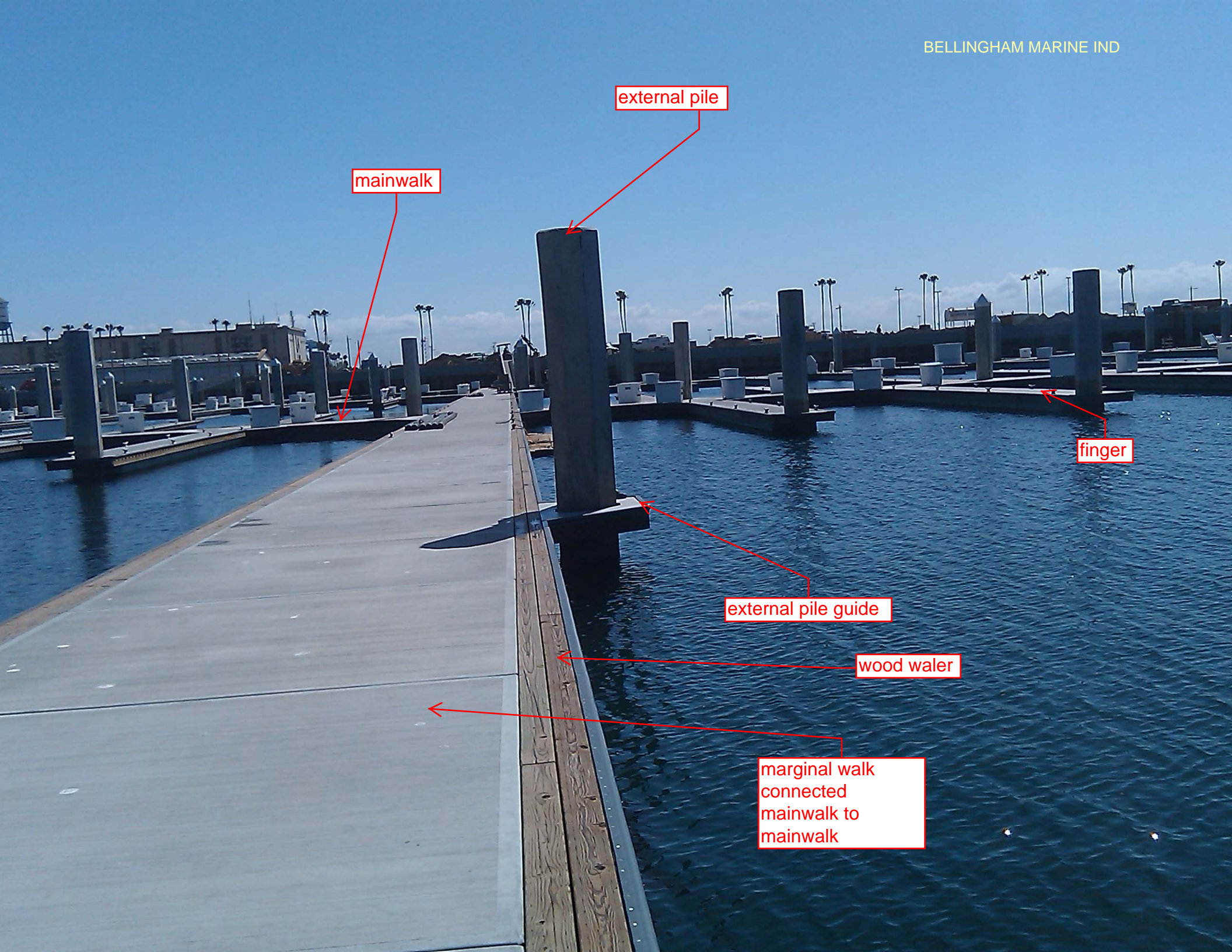
power center inside
dock box

mainwalk

dock box

finger





external pile

mainwalk

finger

external pile guide

wood waler

marginal walk
connected
mainwalk to
mainwalk

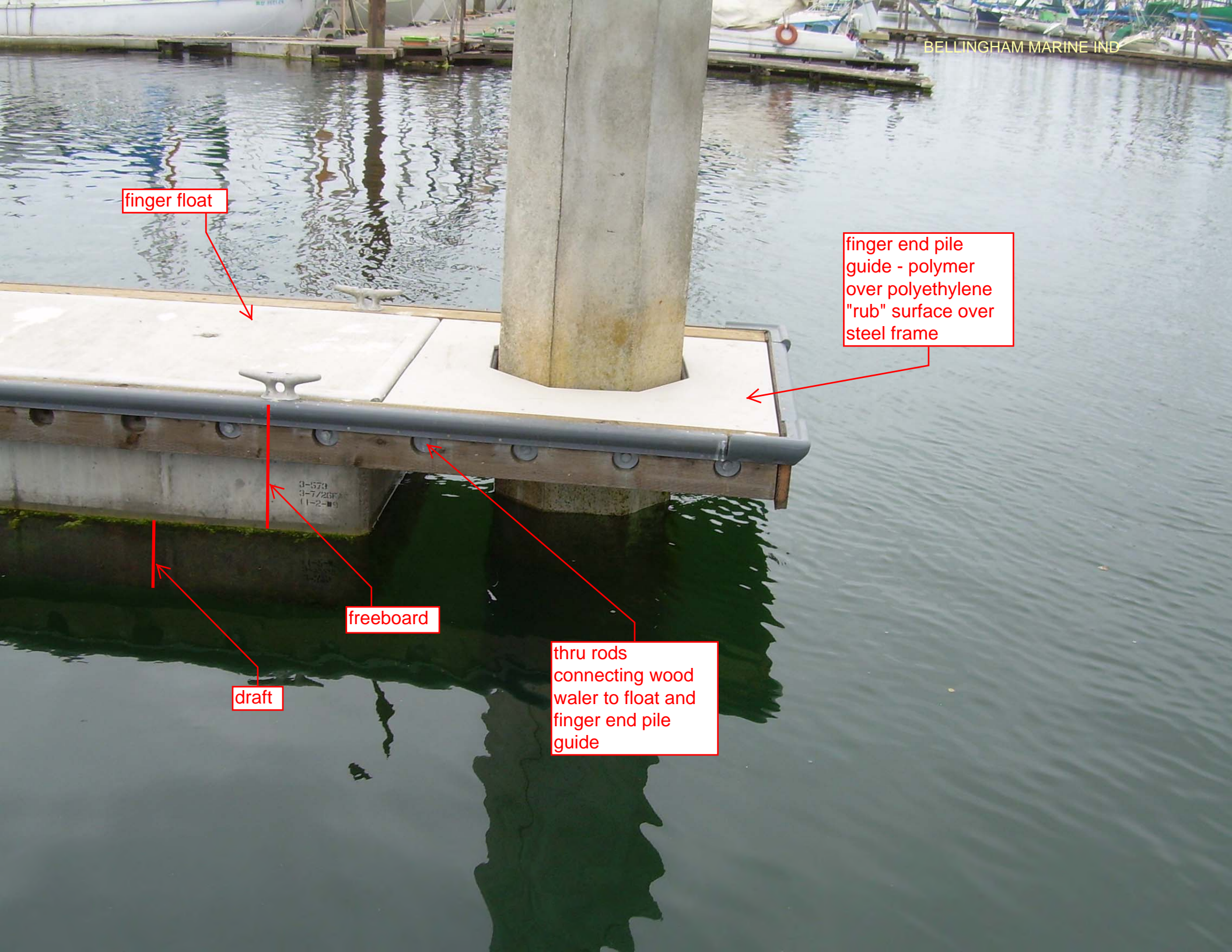
finger float

finger end pile
guide - polymer
over polyethylene
"rub" surface over
steel frame

freeboard

thru rods
connecting wood
waler to float and
finger end pile
guide

draft





mainwalk float section ready to be shipped to site. concrete shell over foam core.

utility access handhole

thru rod connecting waler to float

treated wood waler which connects two mainwalk float section together.

internal utility chase for dry utilities.

893

MA6A

W165

W200

finger float. single piece concrete shell with foam core.

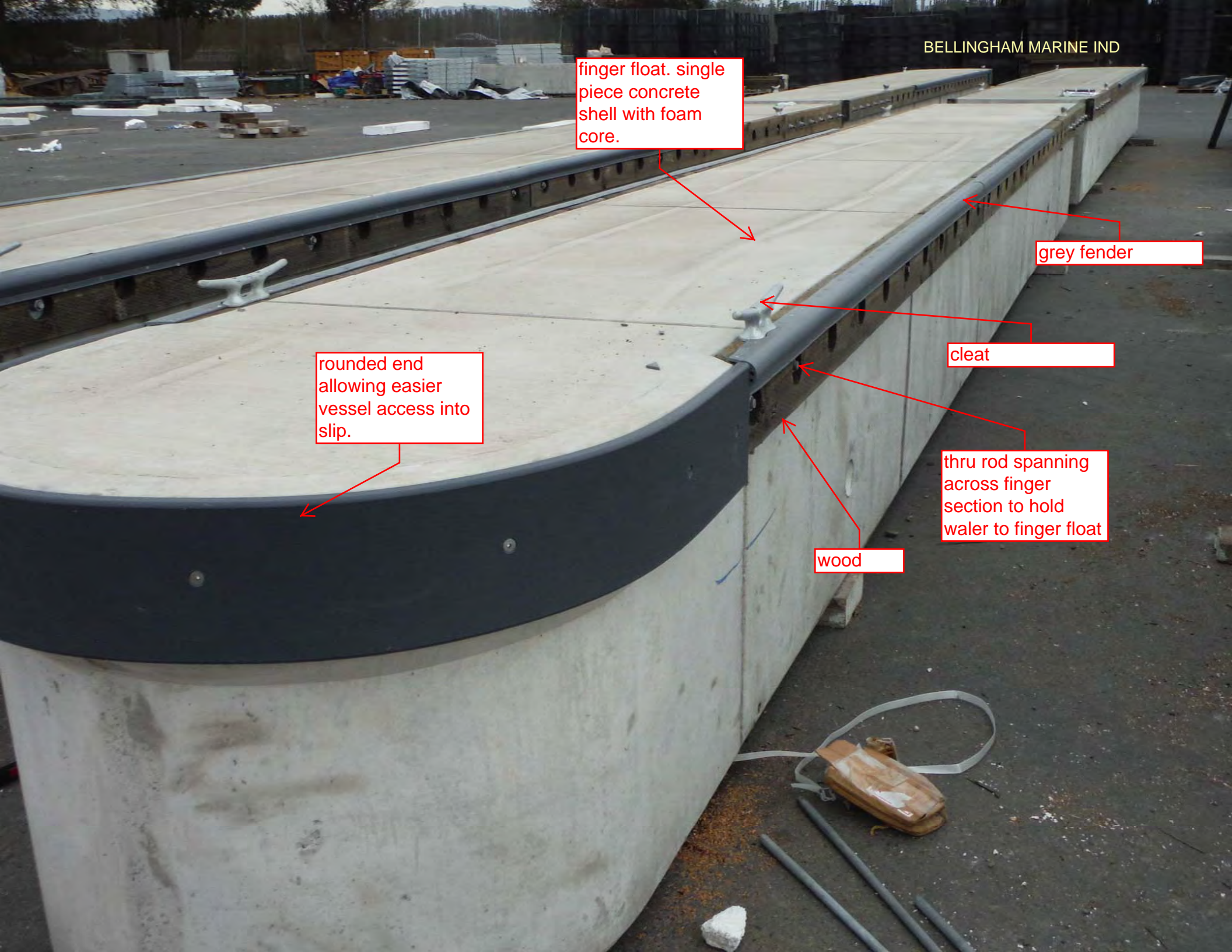
grey fender

rounded end allowing easier vessel access into slip.

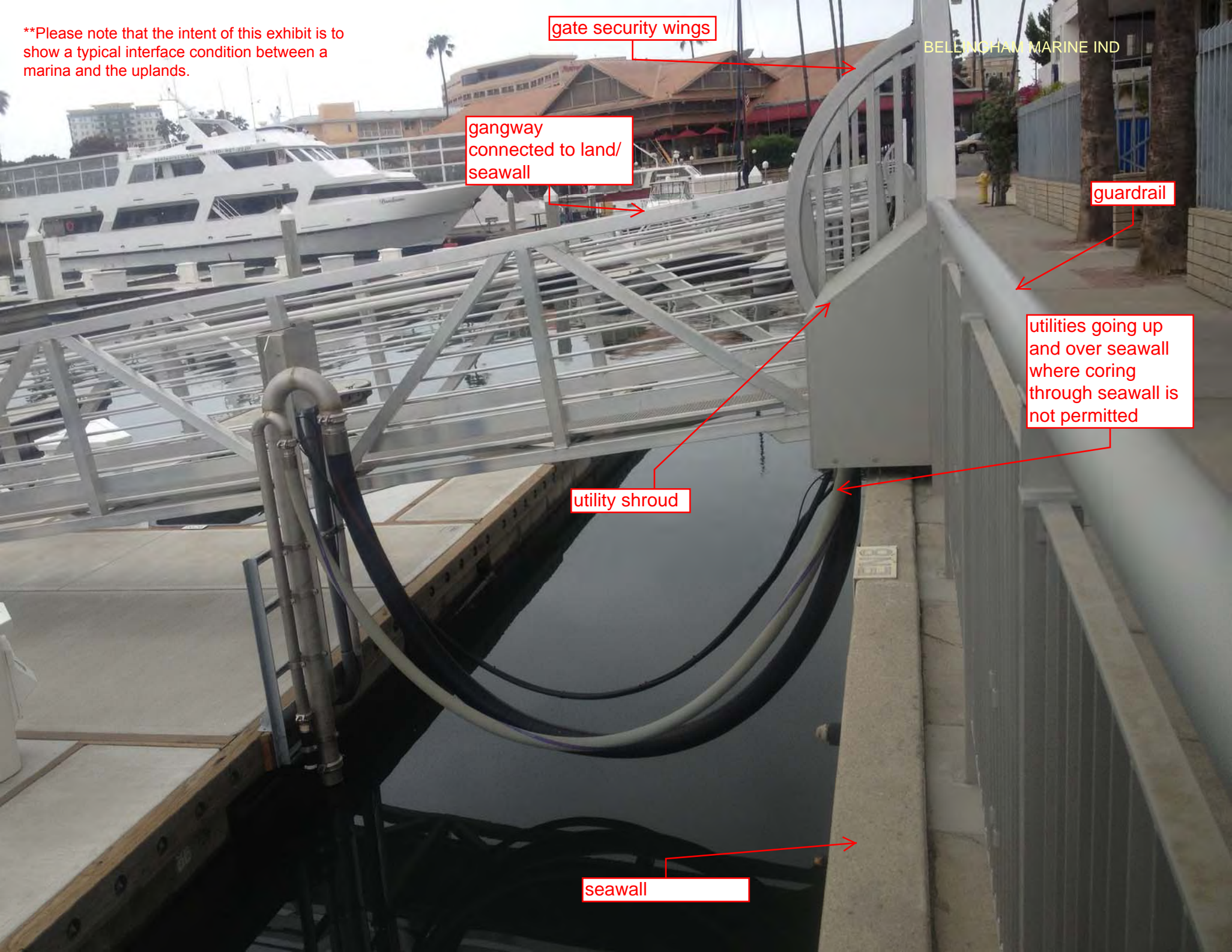
cleat

thru rod spanning across finger section to hold waler to finger float

wood



**Please note that the intent of this exhibit is to show a typical interface condition between a marina and the uplands.



gate security wings

BELENCHAM MARINE IND

gangway
connected to land/
seawall

guardrail

utilities going up
and over seawall
where coring
through seawall is
not permitted

utility shroud

seawall

gangway supported on access pier

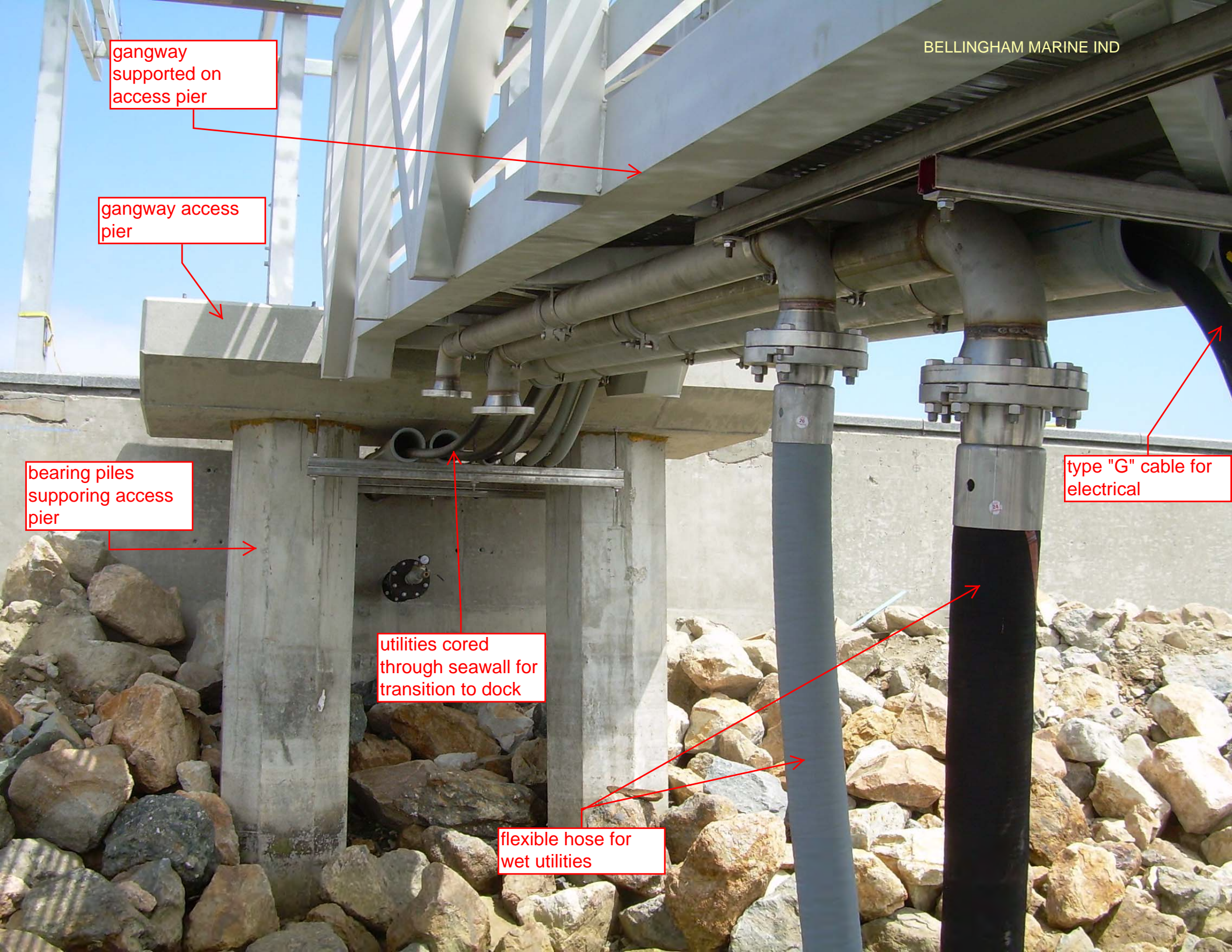
gangway access pier

bearing piles supporting access pier

utilities cored through seawall for transition to dock

flexible hose for wet utilities

type "G" cable for electrical



Appendix B

Bioacoustic Evaluation

Memorandum

September 18, 2017

By: Nicolas Duffort, Anchor QEA, LLC

Re: **Brooklyn Basin Marina Bioacoustics Evaluation**

Project Pile Driving Activities

The project includes pile driving to construct the improvements described in Section 2. A summary of piles planned for installation is presented in Table 1. Pile locations are shown on Figure 2.

Table 1
Brooklyn Basin Marina Project Pile Details

Pile Diameter (inches)	Pile Type	Installation Method	Number of Piles ¹	Piles per Day	Strikes Per Pile ¹
14	Steel	Impact hammer with bubble curtain	50 (permanent)	8	400
16	Steel	Impact hammer with bubble curtain	27 (permanent)	8	425
18	Steel	Impact hammer with bubble curtain	85 (permanent)	8	450

Note:

1. Pile counts and strike counts are approximate, based on preliminary project designs and substrate conditions.

Brooklyn Basin Pile Driving Anticipated Duration

Given the number of piles and piles per day, pile driving activities are anticipated to occur over approximately 21 days. Construction would be limited to the hours of 7:00 a.m. to 8:00 p.m., and the maximum daily duration of construction would therefore be 13 hours per day. Pile driving would only occur from June 1 to November 30, during the salmonid work window. Construction is currently planned to occur in 2018.

Avoidance and Mitigation

The following avoidance and minimization measures would be implemented to address potential impacts to special status fish and marine mammals during periods of pile driving:

- The applicant will obtain and comply with all required resource agency permit conditions, including any required work windows.

- The applicant will ensure that the contractor does the following:
 - The contractor will conduct a visual scan before commencing any pile-driving operations to ensure no mammals are within the immediate vicinity of pile hammering and will employ “soft start” techniques for any impact pile driving.

In addition to the above, the applicant will implement a bubble curtain during pile driving activities to further attenuate noise from the striking of steel piles. Please note that the area of impact occurs in an area under constant use for commercial marine transportation.

Given the brief duration of construction and limited number of piles, as well as the locality of pile driving, the applicant is not proposing to conduct underwater sound pressure monitoring during construction.

Pile Driving Noise Effects on Special Status Fish Species

This section includes a description of special status fish potentially affected by the project, National Marine Fisheries Service (NMFS) impact thresholds for fish, and fish impact areas, as calculated using project variables and the NMFS pile driving acoustic impact worksheet for fish. In consideration of these findings, an impact determination for the project’s effect on special status fish species is provided as follows.

Species Potentially Affected

Pile driving noise may affect common fish species, as well as green sturgeon southern distinct population segment (DPS; federal threatened and state species of special concern) and longfin smelt (federal candidate and state threatened species). As described, pile driving will only occur from June 1 to November 30, when salmonids are not present in the action area. Therefore, sound levels produced from pile driving are not expected to have any effects on listed salmonids. This includes potential pile driving noise impacts to central California coast evolutionarily significant unit (ESU) coho salmon, central California coast DPS steelhead trout, Central Valley DPS steelhead trout, Sacramento River winter-run ESU Chinook salmon, and Central Valley spring-run ESU Chinook salmon. Green sturgeon southern DPS and longfin smelt are year-round residents in the San Francisco Bay, and are likely to be present in the project area during construction.

Acoustic Impact Thresholds and Areas

NMFS has established underwater noise impact thresholds for pile driving noise impacts to fish, as listed in Table 2.

Table 2
NMFS Fish Injury and Behavior Impact Thresholds (Pile Driving)

Injury		Behavior
Peak	Cumulative SEL	
206 dB (all fish)	<ul style="list-style-type: none"> • 187 dB (fish size of 2 grams or greater) • 183 dB (fish size of less than 2 grams) 	150 dB RMS (all fish)

Notes:
dB: decibel
NMFS: National Marine Fisheries Service
RMS: root mean square
SEL: sound exposure level

The NMFS worksheet was completed for the project’s pile driving activities (Attachment 1). The following section describes how the required variables were determined for the project.

Source Sound Levels

Source sound levels for pile driving were obtained from the Compendium of Pile Driving Sound Data (compendium; Caltrans 2012). The compendium includes source sound data recorded at pile driving projects in California, Oregon, Washington, and Nebraska. Source sound levels were identified for 18-inch and 14-inch piles, in order to identify and illustrate the breadth of anticipated bioacoustics impacts from the project, and sound attenuation modeling was completed for each of these sizes. It is anticipated that driving 16-inch piles will generate bioacoustics impacts greater than 14-inch piles, but less than 18-inch piles. Therefore, modeling was only performed for the smallest and largest pile sizes.

For 18-inch steel piles, the most comparable comprehensive data included in the compendium was collected during the Stockton Wastewater Treatment Plant in the San Joaquin River, in Stockton, California. The project included hammer driving 20-inch steel piles with bubble curtain attenuation in shallow waters. This source sound data was selected because the compendium does not include any data for 18-inch piles, and should provide a conservative evaluation of project effects, given that larger piles typically generate louder source noise than smaller piles. These source noise levels are shown in Table 3.

Table 3
18-inch Steel Pile Source Sound Levels
(Pile Driving with Impact Hammer and Bubble Curtain Attenuation)

Pile Type	Source sound at 33 feet (10 meters)		
	Peak Sound (dB)	SEL (single strike)	RMS (dB)
18-inch steel	197 ¹	172.2 ¹	182.2 ¹

Notes:

1. Values represent mean sounds levels observed during Stockton Wastewater Treatment Plant for impact hammer installation of 20-inch piles with unconfined and confined bubble curtain attenuation (Caltrans 2012).

dB: decibel

RMS: root mean square

SEL: sound exposure level

For 14-inch steel piles, the most comparable comprehensive data included in the compendium was collected during the Richmond-San Rafael Bridge Project in the San Francisco Bay, in Marin County, California. The project included hammer driving 14-inch steel piles without attenuation in relatively deep waters. The compendium does not include any data for hammer impact driving 14-inch piles with bubble curtain attenuation. Therefore, the non-attenuated source noise data for the Richmond-San Rafael Bridge Project was modified to fit the project conditions.

The Richmond-San Rafael Bridge project provides source noise data observed at 22 meters, but does not provide source noise data for 10 meter distances (as required for the NMFS calculators) or for use of bubble curtain attenuation (as proposed for the project). Caltrans has identified a 5 decibel (dB) reduction in noise levels at 10 meters with bubble curtain attenuation (for piles less than 24 inches in diameter; CALTRANS 2009). By calculating for reduction in sound levels based on distance (the sound level will decrease by 6 dB every time the source to the listener's distance is doubled), we can identify source noise data for 14-inch piles at 10 meters, and can adjust by 5 dB to account for the bubble curtain attenuation. The source noise sound levels for driving 14-inch steel piles, including values from the compendium and adjusted numbers to account for a 10-meter distance and use of bubble curtain attenuation, are shown in Table 4.

Table 4
14-inch Steel Pile Source Sound Levels
(Pile Driving with Impact Hammer and Bubble Curtain Attenuation)

		Sound Pressure Levels Measured in dB		
Pile Size and Installation Method	Distance	Peak	RMS	SEL
14-inch hammer (no attenuation)	22 meters	196 ¹	180 ¹	170 ¹
14-inch hammer (no attenuation)	10 meters	202.85 ²	186.85 ²	176.85 ²
14-inch hammer (bubble curtain attenuation)	10 meters	197.85 ³	181.85 ³	171.85 ³

Notes:

1. Values represent sound levels observed during Richmond-San Rafael Bridge Project Measured at 22 meters for 14-inch-diameter steel pipe installed with impact hammer (no attenuation; Caltrans 2012)
2. Modified compendium data to account for 6 dB decrease every time the source to the listener's distance is doubled (<http://www.sengpielaudio.com/calculator-distance.htm>)
3. Five dB source noise reduction at 10 meters (piles less than 24 inches in diameter; Caltrans 2009).

dB: decibel

RMS: root mean square

SEL: sound exposure level

Estimated number of pile strikes per day. Pile driving would occur in the soft Bay Mud substrate. Based on these conditions, it is estimated that each 18-inch steel pile would require 450 blows to install, while the 14-inch piles would require 400 blows to install. Given the estimated maximum installation rates of 8 piles per day (for all pile sizes), there would be maximum daily counts of 3,600 and 3,200 blows for the 18-inch and 14-inch piles, respectively.

Transmission loss constant. Site-specific transmission loss information was not available for the project site. As recommended by the NMFS worksheet instructions, a transmission loss constant of 15 was therefore used for both project sites and both pile sizes.

The variables described above were entered into the NMFS worksheet to identify the distances to various fish injury and behavior thresholds for project pile driving activities. These results are presented in Table 5.

**Table 5
Anticipated Underwater Noise Effects and Distances to Fish Injury and Behavior Thresholds
(Pile Driving with Impact Hammer and Bubble Curtain Attenuation)**

Pile Type	Source sound at 33 feet (10 meters)			Number of strikes per pile	Maximum Number of Piles per day	Maximum Strikes Per Day	SEL, accumulated	Distance to 206 dB peak (meters)	Distance to 187 dB SEL (meters)	Distance to 183 dB SEL (meters)	Distance to 150 dB RMS (meters)
	Peak sound, dB	SEL, single strike	RMS, dB								
14-inch steel	197.85 ¹	171.85 ¹	181.85 ¹	400	8	10,000	211.85	3	212	286	1,328
18-inch steel	197 ²	172.2 ²	182.2 ²	450	8	6,750	210.49	3	242	302	1,402

Notes:

1. Values represent sound levels observed during Richmond-San Rafael Bridge Project (Caltrans 2012), modified to account for predicted sound attenuation from proposed bubble curtain.
2. Values represent mean sounds levels observed during Stockton Wastewater Treatment Plant for impact hammer installation of 20-inch piles with unconfined and confined bubble curtain attenuation (Caltrans 2012).

dB: decibel

RMS: root mean square

SEL: sound exposure level

Figures 3 and 4 illustrate the sound pressure radii for physical injury or mortality and behavioral effects to fish from 14-inch and 18-inch pile driving activities.

Special Status Fish Species Impact Assessment

As described in the preceding sections, pile driving would result in underwater noise that would exceed fish injury and behavioral effects within the areas shown on Figures 3 and 4. This section provides a description of the potential effects to green sturgeon and longfin smelt populations and habitats based on those findings.

Injury or Mortality

Although green sturgeon or longfin smelt could be in the vicinity of pile driving, the likelihood of injury or mortality is proportionate to the very low likelihood of presence within the project area and the limit of effects to the duration of construction. Green sturgeon are not anticipated to be injured or killed by elevated sound levels because the duration of impact hammer driving by the project is limited to the construction period, and the area of physical injury associated with increased sound pressure levels (SPLs) during pile driving is extremely small in comparison to the size of the San Francisco Bay. To experience injuries or mortality from high SPLs, exposed green sturgeon or longfin smelt would need to remain within the onset of physical injury zones shown in Figures 3 and 4 during the few days of pile driving.

Tagging studies on green sturgeon in the Bay suggest that green sturgeon do not typically occur in areas along the waterfront for more than minutes to hours at a time (NMFS 2014). In addition, the project area lacks the quality forage and cover favored by both longfin smelt and green sturgeon, and existing vessel activity in the pile driving area likely further precludes the presence of these species within the physical injury zones shown on Figures 3 and 4. In addition, pile driving or other loud equipment would be brought online slowly (as described in the Avoidance and Mitigation section), providing green sturgeon, longfin smelt, or other sensitive species opportunity to disperse from the project area. Therefore, sturgeon or longfin smelt are not expected to be present or remain within the onset of physical injury zone during pile driving. Adjacent areas of the San Francisco Bay are available to accommodate fish leaving the area affected by pile driving. This includes habitat of similar or higher quality than waters affected by the project. Therefore, the potential risk of injury and mortality to the few green sturgeon or longfin smelt that may be present is extremely low.

Behavioral Effects

Within the area shown on Figures 3 and 4, pile driving may result in behavioral impacts to green sturgeon or longfin smelt. This may include temporary abnormal behavior indicative of stress, or a startle response. These responses are likely to diminish after a few pile strikes, or as fish leave the area (NMFS 2014).

The channel areas surrounding the pile driving area of effect will provide startled fish sufficient area to escape to open waters of the San Francisco Bay, and elevated sound levels should not result in significant effects on these individuals. Adjacent channel areas and the larger San Francisco Bay provide habitat of similar or higher quality and provide adequate carrying capacity to support individual green sturgeon or longfin smelt that are temporarily displaced during the pile driving. As described in the Avoidance and Mitigation section, construction equipment will be brought online slowly to further provide green sturgeon or longfin smelt the opportunity to exit the pile driving area of effect.

For these reasons, and given that effects would be limited to the construction period, the behavioral effects to green sturgeon or longfin smelt from pile driving are anticipated to be negligible.

Pile Driving Noise Effects on Marine Mammals

This section includes a description of marine mammals potentially affected by the project, NMFS impact thresholds for marine mammals, and marine mammal impact areas, as calculated using project variables, the NMFS pile driving acoustic impact worksheet for marine mammals (Permanent Threshold Shift [PTS] effects), and spreading loss models (behavioral effects). In consideration of these findings, an impact determination for the project's effect on marine mammals is provided as follows.

Species Potentially Affected

The most common marine mammals to inhabit the project area are Pacific harbor seals (*Phoca vitulina*) and California sea lions (*Zalophus californianus*). Other marine mammal species occasionally inhabit the Bay, including the gray whale (*Eschrichtius robustus*), harbor porpoise (*Phocoena phocoena*), northern elephant seal (*Mirounga angustirostris*), Steller sea lion (*Eumetopias jubatus*), and northern fur seal (*Callorhinus ursinus*; URS 2003). On rare occasions, individual humpback whales (*Megaptera novaeangliae*) have entered the Bay. Southern sea otters (*Enhydra lutris*) may also be rare visitors to the Bay. It is highly unlikely that any of these less-common marine mammals would enter the Bay tidal channel east of Alameda Island.

Acoustic Impact Thresholds and Areas

Permanent Threshold Shift/Level A Thresholds and Areas

The determination of the PTS onset isopleths (i.e., injury distances) in this document are based on the output of a marine mammals pile driving acoustic impact worksheet tool (marine mammals worksheet) developed by NMFS which considers noise levels generated by impact pile driving (NOAA 2016). Table 6 identifies the new acoustic thresholds established in the 2016 guidance for each hearing group for onset of PTS, and lists species from each hearing group that may be present at the project site, including their likely frequency of occurrence.

Table 6
Marine Mammal Acoustic Thresholds for Impulsive Sounds

Hearing Group	Permanent Threshold Shift Onset	Hearing Group Species Potentially Affected	Frequency of Occurrence in Bay	Likelihood of Occurrence in Bay tidal channel east of Alameda Island
Low-frequency cetaceans	183 dB SEL	Gray whale	Transient	Very low
		Humpback whale	Rare	Very low
Mid-frequency cetaceans	185 dB SEL	N/A	N/A	Very low
High-frequency cetaceans	155 dB SEL	Harbor porpoise	Transient	Very low
Phocid pinnipeds (underwater)	185 dB SEL	Pacific harbor seal	Common	Moderate to high
		Northern elephant seal	Transient	Very low
		Northern fur seal	Transient	Very low
Otariid pinnipeds (underwater)	203 dB SEL	California sea lion	Common	Moderate to high
		Steller sea lion	Transient	Very low

Notes:
dB: decibel
N/A: not applicable
SEL: sound exposure level

The marine mammal worksheet includes several methods for calculating the PTS isopleth distances for the various marine mammal hearing groups. Based on the proposed construction activities (in-water pile driving with impact hammer and bubble curtain attenuation) and in consultation with NMFS (NMFS 2017), the E.1-2 Single Strike Equivalent Alternative method was identified as the appropriate calculator for the project.

This method includes inputs for pile driving source noise, number of strikes per day (as factor of strikes per pile and piles per day), and a propagation constant. The PTS isopleths for each marine mammal hearing group were calculated by entering these variables into the marine mammals worksheet. As with the NMFS pile driving acoustic impact worksheet for fish, source sound pile driving source noise was identified from the compendium (see Tables 3 and 4), the estimated number of pile strikes per day was determined based on site and design conditions, and a typical sound propagation constant was used. Table 7 provides a summary of the worksheet PTS isopleths, and the worksheets are included as Attachment 1.

Table 7
Anticipated Underwater Noise Effects and Permanent Threshold Shift Isoleths
(Pile Driving with Impact Hammer and Bubble Curtain Attenuation)

Pile Type	SEL, single strike (at 10 m)	No. of Strikes per Pile	No. of Piles per Day	PTS Isoleth to Threshold by Hearing Group (m)				
				Low-frequency Cetaceans (183 dB SEL)	Mid-frequency Cetaceans (185 dB SEL)	High-frequency Cetaceans (155 dB SEL)	Phocid Pinnipeds (underwater; 185 dB SEL)	Otariid Pinnipeds (underwater; 203 dB SEL)
18-inch steel	172.2 ¹	450	8 (max)	447.0	15.9	532.4	239.2	17.4
14-inch steel	171.85 ²	400	8 (max)	391.6	13.9	466.5	209.6	15.3

Notes:

1. Values represent sound levels observed during Richmond-San Rafael Bridge Project (Caltrans 2012), modified to account for predicted sound attenuation from proposed bubble curtain.
2. Values represent mean sounds levels observed during Stockton Wastewater Treatment Plant for impact hammer installation of 20-inch piles with unconfined and confined bubble curtain attenuation (Caltrans 2012).

dB: decibel

m: meters

SEL: sound exposure level

Figures 5 and 6 illustrate the PTS isopleths from pile driving activities and source noise levels listed in Table 5.

Behavioral/Level B Thresholds and Areas

NMFS identifies impact pile driving disturbance thresholds that are uniform for all types of marine mammals, as shown in Table 8.

Table 8
National Oceanic and Atmospheric Administration Disturbance Thresholds for Marine Mammals

Marine Mammals	Impact Pile Driving Disturbance Threshold
Cetaceans	160 dB RMS
Pinnipeds	

Notes:

db: decibel

RMS: root mean square

The 15 log *R* practical (or semi-cylindrical) spreading loss model was used to calculate the distances to impact pile driving disturbance thresholds shown in Table 8 above. The variables entered into the model include the source sound level and propagation constant described in the previous section. As

with the PTS propagation value, site specific propagation info was not available, so the standard value of 15 was used for both sites. Similarly, background noise levels for the sites are not available, and were conservatively assumed at the standard level of 120 decibels. Table 9 provides a summary of 15 log *R* practical (or semi-cylindrical) spreading loss model results, and the worksheets are included as Attachment 1.

Table 9
Anticipated Underwater Noise Effects and Distances to Marine Mammal Disturbance Thresholds (Pile Driving with Impact Hammer and Bubble Curtain Attenuation)

Pile Type	Source Sound at 10 meters (dB RMS)	Distance to 160 dB Impact Pile Driving Disturbance Threshold (meters)
18-inch steel	182.2 ¹	302
14-inch steel (Fort Baker)	181.85 ²	271

Notes:

1. Values represent sound levels observed during Richmond-San Rafael Bridge Project (Caltrans 2012), modified to account for predicted sound attenuation from proposed bubble curtain.
2. Values represent mean sounds levels observed during Stockton Wastewater Treatment Plant for impact hammer installation of 20-inch piles with unconfined and confined bubble curtain attenuation (Caltrans 2012)

dB: decibel

RMS: root mean square

Figures 7 and 8 illustrate the radius distances listed in Table 7 for behavioral effects from pile driving activities and noise levels.

Marine Mammal Impact Assessment

As described in the preceding sections, pile driving would result in underwater noise that would exceed marine mammal injury and behavioral effect thresholds within the areas shown on Figures 7 and 8. This section provides a description of the potential effects to marine mammal populations based on those findings.

Pinnipeds, including California sea lions and harbor seals, are the most likely to occur in the project area, and there is a very low likelihood of transient occurrence for other marine mammal species. Impact driving of 18-inch and 14-inch steel piles may produce sound pressures that reach PTS thresholds within the local vicinity of the project site, as shown on Figures 5 and 6. With implementation of the measures identified in the Avoidance and Minimization section, which include bringing loud mechanical equipment online slowly, any marine mammals present in the general vicinity of the site during construction would be expected to detect the increased underwater sound pressure and temporarily avoid the construction area. Marine mammals have large home ranges, and are therefore capable of avoiding use of some areas for short periods of time. Avoidance and minimization measures additionally include maintenance of a 500-meter safety zone to ensure that

marine mammals are not present during pile driving. In consideration of these factors and the limit of effects to the duration of construction, pile driving is not anticipated to result in injury to marine mammals.

Nonetheless, there remains potential for pile driving to result in Level B harassment of marine mammals within the area identified in Figures 7 and 8. Project-related disturbance would be expected to have no more than a minor effect on individual animals' range and no effect on migration, breathing, nursing, breeding, feeding, sheltering, or populations of these species, and implementation of the measures identified in the Avoidance and Minimization section would reduce these impacts. Any effects experienced by individual marine mammals are anticipated to be limited to short-term disturbance of normal behavior or temporary displacement of animals near the noise source.

Figures

- Figure 1 Vicinity Map
- Figure 2 Project Site Map
- Figure 3 Fish Injury and Disturbance Zones for 18" Steel Piles
- Figure 4 Fish Injury and Disturbance Zones for 14" Steel Piles
- Figure 5 Marine Mammal PTS Zones for 18" Steel Piles
- Figure 6 Marine Mammal PTS Zones for 14" Steel Piles
- Figure 7 Marine Mammal Level B Harassment Zone for 18" Steel Piles
- Figure 8 Marine Mammal Level B Harassment Zone for 14" Steel Piles

Attachment

- Attachment 1 NMFS Pile Driving Acoustic Impact Worksheets for Fish and Marine Mammals, and 15 log R Practical Spreading Loss Modeling Calculations

References

- Caltrans (California Department of Transportation), 2012. *Compendium of Pile Driving Sound Data*. October 2012.
- Caltrans, 2009. *Final Technical Guidance for Assessment and Mitigation of the Hydroacoustic Effects of Pile Driving on Fish*.
- NMFS (National Marine Fisheries Service), 2017. Email communication with Amy R. Scholik, Ph.D. (NMFS Fishery Biologist). Regarding Marine Mammal PTS Worksheets. January 18, 2017.

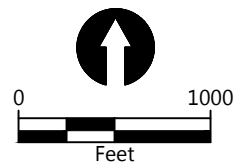
NOAA (National Oceanic and Atmospheric Administration), 2016. *Technical Guidance for Assessing the Effects of Anthropogenic Sound on Marine Mammal Hearing: Underwater Acoustic Thresholds for Onset of Permanent and Temporary Threshold Shifts*. NOAA Technical Memorandum NMFS-OPR-55, 178 p.

URS (URS Corporation), 2003. *Final Program Environmental Impact Report Expansion of Ferry Transit Service in the San Francisco Bay Area*. Prepared for Water Transit Authority. June 2003.

Figures



AERIAL SOURCE: Google Earth Pro, 2016.
HORIZONTAL DATUM: California State Plane, Zone 3,
 NAD83, U.S. Feet.



Publish Date: 2017/07/13 11:29 AM | User: mpratschner
 Filepath: L:\AutoCAD Project Files_Projects\1166-Signature Development\Signature\Brooklyn Basin Marina\1166 RP 004 VIC MAP.dwg AQ-A-Portrait



Figure 1
Vicinity Map
 Brooklyn Basin Development Project



LEGEND:
▨ Proposed Dock Area

Publish Date: 2017/07/07, 12:32 PM | User: ckiblinger
Filepath: \\orcas\gis\Jobs\PacificMarinaDevelopment_1302\Maps\Bioacoustics\Brooklyn_Basin_Bioacoustics_Buffers_DDP.mxd



Figure 2
Project Site Map
Brooklyn Basin Development Project

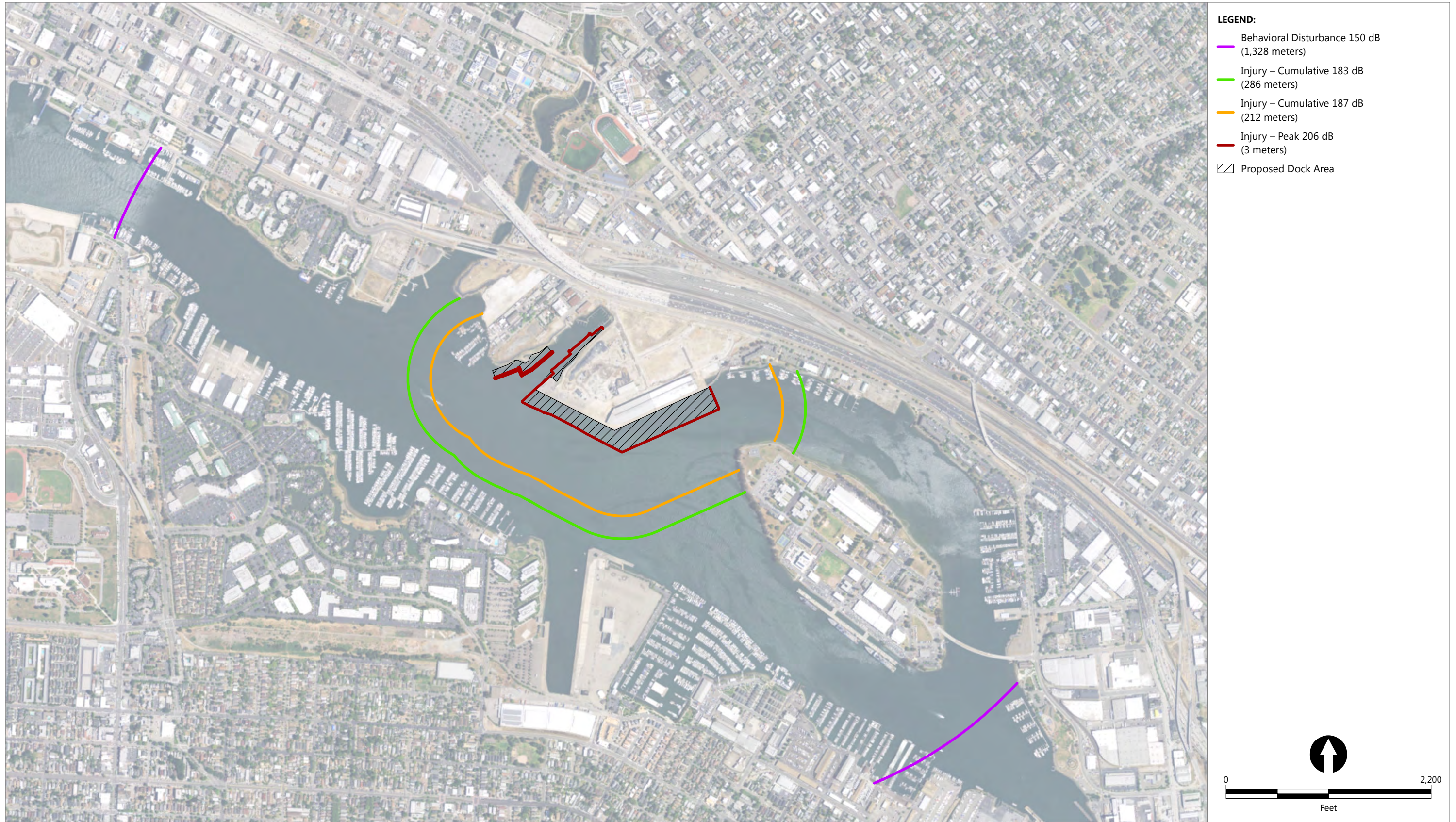


- LEGEND:**
- Behavioral Disturbance 150 dB (1,402 meters)
 - Injury - Cumulative 183 dB (302 meters)
 - Injury - Cumulative 187 dB (242 meters)
 - Injury - Peak 206 dB (3 meters)
 - Proposed Dock Area

Publish Date: 2017/07/07, 12:32 PM | User: ckiblinger
 Filepath: \\orcas\gis\Jobs\PacificMarinaDevelopment_1302\Maps\Bioacoustics\Brooklyn_Basin_Bioacoustics_Buffers_DDP.mxd



Figure 3
Fish Injury and Disturbance Zones for 18" Steel Piles
 Brooklyn Basin Development Project



Publish Date: 2017/07/07, 12:32 PM | User: ckiblinger
 Filepath: \\orcas\gis\Jobs\PacificMarinaDevelopment_1302\Maps\Bioacoustics\Brooklyn_Basin_Bioacoustics_Buffers_DDP.mxd



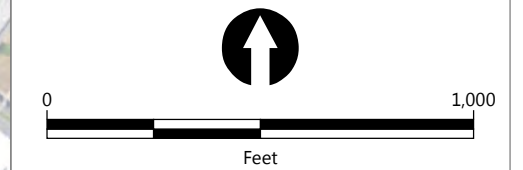
Publish Date: 2017/07/07, 12:32 PM | User: ckiblinger
 Filepath: \\orcas\gis\Jobs\PacificMarinaDevelopment_1302\Maps\Bioacoustics\Brooklyn_Basin_Bioacoustics_Buffers_DDP.mxd



Publish Date: 2017/07/07, 12:32 PM | User: ckiblinger
 Filepath: \\orcas\gis\Jobs\PacificMarinaDevelopment_1302\Maps\Bioacoustics\Brooklyn_Basin_Bioacoustics_Buffers_DDP.mxd



LEGEND:
 — Impact Pile Driving Disturbance
 Threshold 160 dB (302 meters)
 ▨ Proposed Dock Area





Publish Date: 2017/07/07, 12:32 PM | User: ckiblinger
 Filepath: \\orcas\gis\Jobs\PacificMarinaDevelopment_1302\Maps\Bioacoustics\Brooklyn_Basin_Bioacoustics_Buffers_DDP.mxd

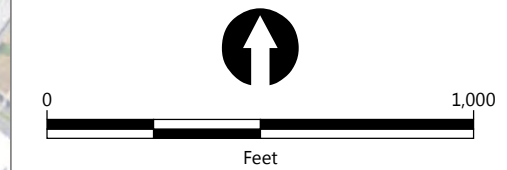


Figure 7
Marine Mammal Level B Harassment Zone for 18" Steel Piles
 Brooklyn Basin Development Project



LEGEND:

-  Proposed Dock Area
-  Impact Pile Driving Disturbance Threshold 160 dB (271 meters)



Publish Date: 2017/07/07, 12:32 PM | User: ckiblinger
 Filepath: \\orcas\gis\Jobs\PacificMarinaDevelopment_1302\Maps\Bioacoustics\Brooklyn_Basin_Bioacoustics_Buffers_DDP.mxd



Figure 8
Marine Mammal Level B Harassment Zone for 14" Steel Piles
 Brooklyn Basin Development Project

Attachment 1

NMFS Pile Driving Acoustic Impact

Worksheets for Fish and Marine Mammals,

and 15 log R Practical Spreading Loss

Modeling Calculations

Project Title	Brooklyn Basin
Pile information (size, type, number, pile strikes, etc.)	14" steel piles, 8 per day maximum, 400 strikes per pile, impact hammer with bubble curtain attenuation.

Fill in green cells: estimated sound levels and distances at which they were measured, estimated number of pile strikes per day, and transmission loss constant.

	Acoustic Metric			Effective Quiet
	Peak	SEL	RMS	
Measured single strike level (dB)	197.85	171.85	181.85	150
Distance (m)	10	10	10	

Estimated number of strikes	3,200
-----------------------------	--------------

Cumulative SEL at measured distance	206.90
-------------------------------------	---------------

	Distance (m) to threshold			
	Onset of Physical Injury			Behavior
	Peak dB	Cumulative SEL dB**		RMS dB
		Fish ≥ 2 g	Fish < 2 g	
Transmission loss constant (15 if unknown)	206	187	183	150
	3	212	286	1328

** This calculation assumes that single strike SELs < 150 dB do not accumulate to cause injury (Effective Quiet)

Notes (source for estimates, etc.)

Source sound source: California Department of Transportation 2007 (for sound levels observed during Richmond-San Rafael Bridge Project, impact hammer driving 14" steel piles, modified to account for predicted sound attenuation from proposed bubble curtain [5 dB at 10 meters])

Project Title	Brooklyn Basin
Pile information (size, type, number, pile strikes, etc.)	18" steel piles, 8 per day maximum, 450 strikes per pile, impact hammer with bubble curtain attenuation.

Fill in green cells: estimated sound levels and distances at which they were measured, estimated number of pile strikes per day, and transmission loss constant.

	Acoustic Metric			
	Peak	SEL	RMS	Effective Quiet
Measured single strike level (dB)	197	172.2	182.2	150
Distance (m)	10	10	10	

Estimated number of strikes	3,600
-----------------------------	-------

Cumulative SEL at measured distance	207.76
-------------------------------------	--------

	Distance (m) to threshold			
	Onset of Physical Injury			Behavior
	Peak dB	Cumulative SEL dB**		RMS dB
		Fish ≥ 2 g	Fish < 2 g	
Transmission loss constant (15 if unknown)	206	187	183	150
	15	3	242	302
				1402

** This calculation assumes that single strike SELs < 150 dB do not accumulate to cause injury (Effective Quiet)

Notes (source for estimates, etc.)

Source sound source: California Department of Transportation 2007 (mean of pile driving data for Stockton Wastewater Treatment Plant required pile driving in the San Joaquin River, in Stockton, CA, in-water noise w/ bubble curtain attenuation 20" steel piles)

E.1: IMPACT PILE DRIVING (STATIONARY SOURCE: Impulsive, Intermittent)

VERSION: 1.1 (Aug-16)

KEY	
	Action Proponent Provided Information
	NMFS Provided Information (Acoustic Guidance)
	Resultant Isoleth

STEP 1: GENERAL PROJECT INFORMATION

PROJECT TITLE	
PROJECT/SOURCE INFORMATION	
Please include any assumptions	
PROJECT CONTACT	

STEP 2: WEIGHTING FACTOR ADJUSTMENT

Specify if relying on source-specific WFA, alternative weighting/dB adjustment, or if using default value

Weighting Factor Adjustment (kHz) [†]	2	
--	---	--

[†] Broadband: 95% frequency contour percentile (kHz) OR Narrowband: frequency (kHz); For appropriate default WFA: See INTRODUCTION tab

[†] If a user relies on alternative weighting/dB adjustment rather than relying upon the WFA (source-specific or default), they may override the Adjustment (dB) (row 64), and enter the new value directly. However, they must provide additional support and documentation supporting this modification.

*** BROADBAND Sources: Cannot use WFA higher than maximum applicable frequency (See GRAY tab for more information on WFA applicable frequencies)**

STEP 3: SOURCE-SPECIFIC INFORMATION

NOTE: Choose either E1-1 OR E.1-2 method to calculate isopleths (not required to fill in sage boxes for both)

E.1-1: METHOD USING RMS SPL SOURCE LEVEL

Source Level (RMS SPL)	
Activity Duration (h) within 24-h period OR Number of piles per day	
Pulse Duration ^a (seconds)	
Number of strikes in 1 h OR Number of strikes per pile	
Activity Duration (seconds)	0
10 Log (duration)	#NUM!
Propagation (xLogR)	
Distance of source level measurement (meters) [*]	

^aWindow that makes up 90% of total cumulative energy (5%-95%) based on Madsen 2005

^{*}Unless otherwise specified, source levels are referenced 1 m from the source.

Marine Mammal Hearing Group
Low-frequency (LF) cetaceans: baleen whales
Mid-frequency (MF) cetaceans: dolphins, toothed whales, beaked whales, bottlenose whales
High-frequency (HF) cetaceans: true porpoises, <i>Kogia</i> , river dolphins, cephalorhynchid, <i>Lagenorhynchus cruciger</i> & <i>L. australis</i>
Phocid pinnipeds (PW): true seals
Otariid pinnipeds (OW): sea lions and fur seals

RESULTANT ISOPLETHS*

*Note: For impulsive sounds, action proponent must also consider isopleths peak sound pressure level (PK) thresholds (dual thresholds).

Hearing Group	Low-Frequency Cetaceans	Mid-Frequency Cetaceans	High-Frequency Cetaceans	Phocid Pinnipeds	Otariid Pinnipeds
SEL _{cum} Threshold	183	185	155	185	203
PTS Isoleth to threshold (meters)	#NUM!	#NUM!	#NUM!	#NUM!	#NUM!

E.1-2: ALTERNATIVE METHOD (SINGLE STRIKE EQUIVALENT)

Unweighted SEL _{cum} (at measured distance) = SEL _{ss} + 10 Log (# strikes)	206.9
---	-------

Source Level (Single Strike/shot SEL)	171.85
Number of strikes in 1 h OR Number of strikes per pile	400
Activity Duration (h) within 24-h period OR Number of piles per day	8
Propagation (xLogR)	15
Distance of single strike SEL measurement (meters) [*]	10

^{*}Unless otherwise specified, source levels are referenced 1 m from the source.

Marine Mammal Hearing Group
Low-frequency (LF) cetaceans: baleen whales
Mid-frequency (MF) cetaceans: dolphins, toothed whales, beaked whales, bottlenose whales
High-frequency (HF) cetaceans: true porpoises, <i>Kogia</i> , river dolphins, cephalorhynchid, <i>Lagenorhynchus cruciger</i> & <i>L. australis</i>
Phocid pinnipeds (PW): true seals
Otariid pinnipeds (OW): sea lions and fur seals

RESULTANT ISOPLETHS*

*Note: For impulsive sounds, action proponent must also consider isopleths peak sound pressure level (PK) thresholds (dual thresholds).

Hearing Group	Low-Frequency Cetaceans	Mid-Frequency Cetaceans	High-Frequency Cetaceans	Phocid Pinnipeds	Otariid Pinnipeds
SEL _{cum} Threshold	183	185	155	185	203
PTS Isoleth to threshold (meters)	391.6	13.9	466.5	209.6	15.3

WEIGHTING FUNCTION CALCULATIONS

Weighting Function Parameters	Low-Frequency Cetaceans	Mid-Frequency Cetaceans	High-Frequency Cetaceans	Phocid Pinnipeds	Otariid Pinnipeds
a	1	1.6	1.8	1	2
b	2	2	2	2	2
f ₁	0.2	8.8	12	1.9	0.94
f ₂	19	110	140	30	25
c	0.13	1.2	1.36	0.75	0.64
Adjustment (dB) [†]	-0.01	-19.74	-26.87	-2.08	-1.15

$$W(f) = C + 10 \log_{10} \left\{ \frac{(f/f_1)^{2a}}{[1 + (f/f_1)^2]^a [1 + (f/f_2)^2]^b} \right\}$$

E.1: IMPACT PILE DRIVING (STATIONARY SOURCE: Impulsive, Intermittent)

VERSION: 1.1 (Aug-16)

KEY	
	Action Proponent Provided Information
	NMFS Provided Information (Acoustic Guidance)
	Resultant Isoleth

STEP 1: GENERAL PROJECT INFORMATION

PROJECT TITLE	
PROJECT/SOURCE INFORMATION	
Please include any assumptions	
PROJECT CONTACT	

STEP 2: WEIGHTING FACTOR ADJUSTMENT

Specify if relying on source-specific WFA, alternative weighting/dB adjustment, or if using default value

Weighting Factor Adjustment (kHz) [†]	2	
--	---	--

[†] Broadband: 95% frequency contour percentile (kHz) OR Narrowband: frequency (kHz); For appropriate default WFA: See INTRODUCTION tab

[†] If a user relies on alternative weighting/dB adjustment rather than relying upon the WFA (source-specific or default), they may override the Adjustment (dB) (row 64), and enter the new value directly. However, they must provide additional support and documentation supporting this modification.

* BROADBAND Sources: Cannot use WFA higher than maximum applicable frequency (See GRAY tab for more information on WFA applicable frequencies)

STEP 3: SOURCE-SPECIFIC INFORMATION

NOTE: Choose either E1-1 OR E.1-2 method to calculate isopleths (not required to fill in sage boxes for both)

E.1-1: METHOD USING RMS SPL SOURCE LEVEL

Source Level (RMS SPL)	
Activity Duration (h) within 24-h period OR Number of piles per day	
Pulse Duration ^a (seconds)	
Number of strikes in 1 h OR Number of strikes per pile	
Activity Duration (seconds)	0
10 Log (duration)	#NUM!
Propagation (xLogR)	
Distance of source level measurement (meters) [*]	

^aWindow that makes up 90% of total cumulative energy (5%-95%) based on Madsen 2005

*Unless otherwise specified, source levels are referenced 1 m from the source.

Marine Mammal Hearing Group	
Low-frequency (LF) cetaceans:	baleen whales
Mid-frequency (MF) cetaceans:	dolphins, toothed whales, beaked whales, bottlenose whales
High-frequency (HF) cetaceans:	true porpoises, <i>Kogia</i> , river dolphins, cephalorhynchid, <i>Lagenorhynchus cruciger</i> & <i>L. australis</i>
Phocid pinnipeds (PW):	true seals
Otariid pinnipeds (OW):	sea lions and fur seals

RESULTANT ISOPLETHS*

*Note: For impulsive sounds, action proponent must also consider isopleths peak sound pressure level (PK) thresholds (dual thresholds).

Hearing Group	Low-Frequency Cetaceans	Mid-Frequency Cetaceans	High-Frequency Cetaceans	Phocid Pinnipeds	Otariid Pinnipeds
SEL _{cum} Threshold	183	185	155	185	203
PTS Isoleth to threshold (meters)	#NUM!	#NUM!	#NUM!	#NUM!	#NUM!

E.1-2: ALTERNATIVE METHOD (SINGLE STRIKE EQUIVALENT)

Unweighted SEL _{cum} (at measured distance) = SEL _{ss} + 10 Log (# strikes)	207.8
---	-------

Source Level (Single Strike/shot SEL)	172.2
Number of strikes in 1 h OR Number of strikes per pile	450
Activity Duration (h) within 24-h period OR Number of piles per day	8
Propagation (xLogR)	15
Distance of single strike SEL measurement (meters) [*]	10

*Unless otherwise specified, source levels are referenced 1 m from the source.

Marine Mammal Hearing Group	
Low-frequency (LF) cetaceans:	baleen whales
Mid-frequency (MF) cetaceans:	dolphins, toothed whales, beaked whales, bottlenose whales
High-frequency (HF) cetaceans:	true porpoises, <i>Kogia</i> , river dolphins, cephalorhynchid, <i>Lagenorhynchus cruciger</i> & <i>L. australis</i>
Phocid pinnipeds (PW):	true seals
Otariid pinnipeds (OW):	sea lions and fur seals

RESULTANT ISOPLETHS*

*Note: For impulsive sounds, action proponent must also consider isopleths peak sound pressure level (PK) thresholds (dual thresholds).

Hearing Group	Low-Frequency Cetaceans	Mid-Frequency Cetaceans	High-Frequency Cetaceans	Phocid Pinnipeds	Otariid Pinnipeds
SEL _{cum} Threshold	183	185	155	185	203
PTS Isoleth to threshold (meters)	447.0	15.9	532.4	239.2	17.4

WEIGHTING FUNCTION CALCULATIONS

Weighting Function Parameters	Low-Frequency Cetaceans	Mid-Frequency Cetaceans	High-Frequency Cetaceans	Phocid Pinnipeds	Otariid Pinnipeds
a	1	1.6	1.8	1	2
b	2	2	2	2	2
f ₁	0.2	8.8	12	1.9	0.94
f ₂	19	110	140	30	25
c	0.13	1.2	1.36	0.75	0.64
Adjustment (dB) [†]	-0.01	-19.74	-26.87	-2.08	-1.15

$$W(f) = C + 10 \log_{10} \left\{ \frac{(f/f_1)^{2a}}{[1 + (f/f_1)^2]^a [1 + (f/f_2)^2]^b} \right\}$$

Practical Spreading Loss Model Evaluation for behavioral effects (Level B) for Brooklyn Basin

$$R1 = 10^{TL/25} * R2$$

R1 = distance to threshold
 TL = Measured noise - target noise
 R2 = noise measurement (10 meters)

dB RMS values of measured source sound

Impact Pile with attenuation
 14-inch steel impact 181.85 dB RMS

14-inch Pipe Pile Impact
 Distance to 120 - Not applicable no vibratory pile driving

Distance to 160 dB RMS
 $R1 = (10^{(181.85-160)/15}) * 10$
 R1 = 271 m

Level B Disturbance Thresholds - remain unchanged with new guidance; injury thresholds now updated

Functional Hearing Group	Airborne Noise Thresholds	Underwater Noise Thresholds		
	In-Air Sound Pressure Level (RMS)	Vibratory Pile Driving Disturbance Threshold	Impact Pile Driving Disturbance Threshold	Injury Threshold
Pinnipeds	90 dB _{rms} (un-weighted) for Pacific harbor seals; 100 dB _{rms} (un-weighted) for sea lions and all other pinnipeds (re: 20 lPa ² sec)	120 dB _{rms}	160 dB _{rms}	190 dB _{rms}
Cetaceans	N/A	120 dB _{rms}	160 dB _{rms}	180 dB _{rms}

Practical Spreading Loss Model Evaluation for behavioral effects (Level B) for Brooklyn Basin

$$R1 = 10^{TL/25} * R2$$

R1 = distance to threshold
 TL = Measured noise - target noise
 R2 = noise measurement (10 meters)

dB RMS values of measured source sound

Impact Pile with attenuation
 20-inch steel impact 182.2 dB RMS
 *20-inch used as equivalent to 18-inch

20-inch Pipe Pile Impact (equivalent to 18-inch)
 Distance to 120 - Not applicable no vibratory pile driving

Distance to 160 dB RMS
 $R1 = (10^{(182.2-160)/15}) * 10$
 R1 = 302 m

Level B Disturbance Thresholds - remain unchanged with new guidance; injury thresholds now updated

Functional Hearing Group	Airborne Noise Thresholds	Underwater Noise Thresholds		
	In-Air Sound Pressure Level (RMS)	Vibratory Pile Driving Disturbance Threshold	Impact Pile Driving Disturbance Threshold	Injury Threshold
Pinnipeds	90 dB _{rms} (un-weighted) for Pacific harbor seals; 100 dB _{rms} (un-weighted) for sea lions and all other pinnipeds (re: 20 lPa ² sec)	120 dB _{rms}	160 dB _{rms}	190 dB _{rms}
Cetaceans	N/A	120 dB _{rms}	160 dB _{rms}	180 dB _{rms}

Appendix C

Water Quality Management Plan

September 2017
Brooklyn Basin Marina



Water Quality Management Plan

Prepared for

Brooklyn Basin Marina, LP
3415 Via Lido, Suite G
Newport Beach, California 92663

Prepared by

Anchor QEA, LLC
130 Battery Street, Suite 400
San Francisco, California 94111

1 Introduction

This Water Quality Management Plan was prepared by Anchor QEA, LLC, for the proposed Brooklyn Basin Marina project (Project). The plan specifically outlines best management practices (BMPs) to be used to control adverse impacts to water quality related to long-term, water-borne vessel berthing. The plan also provides management measures related to boat maintenance and use that should be taken by persons using the marina to protect water quality.

The information provided herein draws largely from the Clean Marina Certification requirements established through the Clean Marinas Program (Clean Marinas 2017). Additionally, this plan is consistent with the U.S. Environmental Protection Agency's *National Management Measures to Control Nonpoint Source Pollution from Marinas and Recreational Boating* (USEPA 2001) and the *California Clean Marina Toolkit* (Gordon and Matuk 2004).

This plan will be continuously updated, as needed, based on site-specific factors within the overall context of the project location, environment, and needs of the marina and its tenants. A copy of the current Water Quality Management Plan will be available at the dock master's office and at all dock entrances and will be included with all slip lease agreements.

2 Boat Cleaning Management Measures

Preventing the entry of chemicals from boat cleaners, cleaning solvents, and antifoulant paint into marina waters is the most direct way to prevent harm to the aquatic environment from boat cleaning products. This management measure addresses pollutants associated with cleaning agents (e.g., detergents, solvents, and degreasing agents), residues resulting from displacement of coatings from vessel surfaces, and sediments resulting from washing operations. Adherence to these BMPs will minimize the risk of discharging cleaning compounds, paint and varnish residues, and contaminated sediments into the environment.

General BMPs proposed for boat cleaning are as follows:

- Marina users should not perform in-water hull scraping or any abrasive process that removes paint underwater.
- Liquid wastes should not be intentionally discharged onto the ground nor allowed to enter storm drains or waterbodies.
- Tarps and vacuums should be used to collect solid wastes produced by cleaning and repairing boats. No waste should enter the water.

2.1 Topside Boat Maintenance and Cleaning

BMPs proposed for topside boat maintenance and cleaning are as follows:

- Reduce use of toxic cleaning product
 - Only detergents and cleaning components that are designated by the manufacturer as phosphate-free and biodegradable should be used, and the amounts used should be minimized. Detergents containing ammonia, sodium hypochlorite, chlorinated solvents, petroleum distillates, or lye are prohibited.
 - Boaters should reduce the need for boat soaps by scrubbing and rinsing with freshwater after each trip.
 - Canvas boat covers should be used to keep boats clean between trips and to reduce the amount of cleaning needed.
 - Spills and debris should be contained using tarps or other measures.
 - Debris should be collected using vacuums or brooms.
- Conduct spill-proof cleaning and maintenance activities
 - Maintenance work should be conducted aboard boats, not on the docks or over the water.
 - Paints, varnish, epoxy, and other products should be mixed over a tarp or in a drip pan to catch spills and drips. Absorbents should be kept nearby to wipe up spills.
 - Product containers should be tightly sealed when not in use to reduce spills.
 - Scuppers should be plugged to contain spills.

- Minimize emissions from surface preparation
 - Tarps or visquine (sheet plastic) should be used to catch and control falling debris. Boaters should frequently vacuum or sweep to prevent discharge of debris into the water.
 - For small jobs conducted in water, tarps or visquine should be attached from boat to dock to catch debris. Boat should be reversed in the slip to work on the other side.
 - Sanding dust should be disposed of in the trash.
 - Scuppers should be plugged to contain dust, debris, and spills.

2.2 Underwater Boat Hull Cleaning

BMPs for underwater boat hull cleaning are as follows:

- Use less toxic hull paints and antifouling strategies
 - An environmentally friendly antifouling strategy should be considered (i.e., combining the use of less toxic paints and bottom coatings with mechanical means to control growth). Less toxic bottom coatings provide alternatives to soft sloughing paints that release heavy metals.
 - Properly functioning antifouling paint will repel all hard growth and requires only occasional light wiping with a soft cloth to remove slime. Aggressive cleaning of antifouling paint using tools, such as scrubbing pads and powered rotary brushes, will significantly shorten the effective life of the paint and should be avoided.
 - In-water boat hull washing is only permitted by hand.
 - In-water hull scraping or any process that occurs under water and results in the removal of paint from boat hulls is prohibited.
 - Regular hull cleaning and maintenance is encouraged to reduce the build-up of hard marine growth and eliminate the need for hard scrubbing. Regularly scheduled gentle cleaning will also increase the effectiveness of the antifouling hull paint and extend its useful life.
 - Hull cleaning should be performed in accordance with the manufacturer's recommendations for the type of hull coating or bottom paint.
 - Zinc anodes should be taken back to shore and recycled or disposed of properly.

3 Invasive Species Management Measure

Boats can carry invasive species on the hull, bilges, bait tanks, and seawater systems. Aquatic species (such as quagga and zebra mussels) are hard to control and can harm native marine life, damage structures and shorelines, and clog water lines.

Implementing the following BMPs will limit the spread of invasive species:

- Live wells, bilge water, and transom wells should be drained before leaving the vicinity of boat use.
- After leaving the water, boat and boat accessories should be inspected, and any plants or animals found should be disposed of by placing them in the garbage bin.
- Bait buckets should be emptied on land, never into the water.
- Live fish or other organisms should not be dumped from one body of water into another one.
- Boat, tackle, downriggers, and trailer should be washed with hot water.
- Water should be flushed through the boat motor's cooling system and other parts of the boat that normally get wet. If possible, let everything dry for 5 days in the hot sun before using the boat in another body of water.

4 Solid and Liquid Waste Management Measures

The purpose of this management measure is to prevent solid waste from polluting surface waters. Solid waste can collect at marinas, yacht clubs, and boat ramp sites and enter surface waters if litter is not continuously picked up. Final locations of the trash and recycling receptacles will be determined at a later time.

BMPs proposed for solid and liquid waste are as follows:

- All trash, recyclables, and hazardous wastes or potential water contaminants—including old gasoline or gasoline with water, absorbent materials, oily rags, lead acid batteries, antifreeze, waste diesel, kerosene, and mineral spirits—should be disposed of in the separate trash containers and in a proper manner. These materials should not at any time be disposed of in the water or gutter.
- Plastics and trash should not be dumped overboard.
- All containers and trash should be properly placed onboard to prevent them from being blown overboard.
- Monofilament fishing line should be returned to recycling bins at the marina or local tackle shop or sent directly to the Berkley Recycling Center (1900 18th Street, Spirit Lake, Iowa 51360-1099).
- Recyclable hazardous waste should be segregated from other waste and taken to a hazardous waste disposal facility to be recycled. Recyclable hazardous waste includes lead-acid batteries, used oil, oil filters, antifreeze, and zinc anodes.

5 Petroleum Control Management Measures

Fuel can be easily spilled into surface waters from the fuel tank air vent while fueling a boat (if overfilling), and oil can be easily discharged during bilge pumping. Because of gasoline's flammability, spills are also a safety problem. Awareness of the issues associated with boat engines and their maintenance is important, because engines are potential sources of nonpoint source pollution and their operation and maintenance have the potential to affect marina waters. Implementation of the BMPs outlined below can minimize the entry of petroleum from fueling and bilge pumping into surface waters.

BMPs proposed for petroleum control are as follows:

- Perform preventive engine maintenance
 - Boaters should practice preventive engine maintenance and should use oil absorbents in the bilge and under the engine to prevent oil and fuel discharges. Oil absorbent materials should be examined at least once a year and replaced as necessary. Used oil absorbents are hazardous waste in California and must be disposed of in accordance with hazardous waste disposal regulations.
 - Boaters should regularly inspect and maintain engines, seals, gaskets, lines, and hoses in order to prevent oil and fuel spills. The use of soaps that can be discharged by bilge pumps is discouraged.
 - U.S. Coast Guard-approved alcohol-resistant fuel lines should be used.
 - Drip pans should be installed under all equipment that might leak.
 - Use of solvents or toxic chemicals to clean engine parts should be minimized. Use mechanical means (such as hand-scraping caked oil) or less toxic solvents (water-based). Do not let solvent run into the bilge.
 - Fluids should be transferred and removed with care, using funnels, pumps, and absorbents to eliminate drips and spills and to keep the bilge area clean.
- Conduct bilge care and prevent oil spills
 - If the bilge needs more extensive cleaning (e.g., due to spills of engine fuels, lubricants, or other liquid materials), boaters are encouraged to use preventive engine maintenance, oil absorbents, bilge pump-out services, or steam cleaning services as much as possible to clean oily bilge areas.
- Report oil and chemical spills
 - Soaps should not be applied to disperse the sheen if a spill is noticed (it is illegal).
 - Spills of oil or chemicals should be reported to (800)424-8802, (800) OILS911, and to the marina office.
 - Oil changes should be spill proofed, and used oil recycled.

- When changing oil, a closed system—a portable vacuum oil change pump drained into a container that can be closed to prevent spills during transfer of oil (available at most marine supply stores)—should be used.
- Used oil should not be mixed with other waste; keep it segregated for recycling.
- Used motor oil, oil filters, and fuel filters should be recycled at a used oil recycling facility.
- Oil-only absorbents should be kept on hand to wipe up spills.
- Saturated oil-absorbents are hazardous wastes and should be disposed of at the marina, the fuel dock, or at a hazardous waste disposal facility.
- Use safe, spill-proof fueling practices
 - Motors, lights, and electrical equipment should be turned off. Cigarettes and any other sources of ignition should be extinguished.
 - Fuel-soaked absorbents should be kept away from sources of ignition. Doors, hatches, ports, and entryways should be kept closed and blowers turned off.
 - Nozzle contact should be maintained with the fill pipe to prevent static spark and spills.
 - The automatic shut-off nozzle should not be relied on to prevent spills; they do not shut off in time.
 - The capacity of the tank should be known; leave the tank at least 5 percent empty because fuel expands.
 - An absorbent sheet should be held under the nozzle to catch drips, and fuel-soaked absorbents should be properly disposed of as hazardous waste.

BMPs for fueling are as follows:

- Fueling built-in tanks
 - Tanks should be filled slowly to prevent overflows from the air vent; avoid “topping off” the tank.
 - A fuel spill container should be attached to cover the air vent and catch spills (if available).
 - A fuel-air separator should be installed in air vent line to prevent spills or “splash back.”
 - When fueling, hands should be kept at the air vent (or listen) as air gushes when the tank is nearly full.
 - At the end of boating season, tanks should be left full to reduce corrosion and condensation. Fuel stabilizer should be added to prevent stale gas.
- Fueling outboard engines
 - Fuel on land whenever possible.
 - Funnels should be used when filling portable tanks or spill-proof portable containers, and oil-only absorbents should be kept on hand to catch spills.
 - Fuel tanks should be kept empty during long periods of inactivity to prevent stale gas.

6 Public Education Management Measures

Public education is one of the most effective ways to reduce pollution from recreational boating in and around marinas. A boating public that understands the causes and effects of pollution is more likely to want clean waters and healthy aquatic environments. The marina owner must effectively convey information to tenants, contractors, and other individuals visiting the marina to successfully implement this management measure.

Recommended BMPs for public education are as follows:

- *Use signs to inform marina patrons of appropriate clean boating practices.* Interpretive and instructional signs positioned at key locations in the marina can be a key method of providing information to the boating public.
- *Establish bulletin boards for environmental messages and idea sharing.* Bulletin boards are a form of signage, and they allow marinas to post recent or new information for the benefit of their patrons. They are convenient places to post notices about the availability of dustless sanders for rent, environmentally friendly cleaners and antifouling paints, new practices and programs at the marina for reducing pollution, water quality monitoring results, how to maintain an engine to keep emission output low, or any other positive clean boating message.
- *Hand out pamphlets or flyers, send newsletters, and add inserts to bill mailings with information about how recreational boaters can protect the environment and have clean boating waters.* Written materials can be made available at the marina office, supply store, or other places frequently visited by boaters or included with bills mailed to patrons, new tenants, and each year to repeat tenants.
- *Implement Dockwalker Program.* The Clean Marinas Program encourages marinas to have their staff become Dockwalkers or participate in a similar program. Dockwalkers are trained in teaching boaters environmentally sound boating habits. Dockwalkers distribute free educational materials (Boater Kits) to boaters and share information about clean boating practices and the location of services that support clean boating efforts.
- *Educate marina staff to do their jobs in an environmentally conscious manner and to be good role models for marina patrons.*
- *Provide facility contract language that promotes tenant use of certain areas and clean boating techniques when maintaining their boats.* The contract should ensure that tenants will comply with the marina's BMPs. The contract language should also outline enforcement provisions, including eviction from the marina and notice of possible civil or criminal fines and/or penalties, to assure compliance with this program by all marina tenants.

7 Conclusion

This Water Quality Management Plan outlines the management measures for the proposed Project. As implemented, the plan will control adverse impacts to water quality related to long-term use of the marina. This plan will be refined as necessary based on location, environment, design, and needs of the marina and its tenants.

8 References

Clean Marinas, 2017. Clean Marinas Program. Accessed on June 27, 2017. Available from:
<http://www.cleanmarina.org/thecleanmanual.html>.

Gordon, M.F. and Matuk, V., 2004. *California Clean Marina Toolkit*. May 2004.

USEPA (U.S. Environmental Protection Agency), 2001. *National Management Measures to Control Nonpoint Source Pollution from Marinas and Recreational Boating*. USEPA 841-B-01-005. November 2001.

Appendix C

Water Quality Management Plan

September 2017
Brooklyn Basin Marina



Water Quality Management Plan

Prepared for

Brooklyn Basin Marina, LP
3415 Via Lido, Suite G
Newport Beach, California 92663

Prepared by

Anchor QEA, LLC
130 Battery Street, Suite 400
San Francisco, California 94111

1 Introduction

This Water Quality Management Plan was prepared by Anchor QEA, LLC, for the proposed Brooklyn Basin Marina project (Project). The plan specifically outlines best management practices (BMPs) to be used to control adverse impacts to water quality related to long-term, water-borne vessel berthing. The plan also provides management measures related to boat maintenance and use that should be taken by persons using the marina to protect water quality.

The information provided herein draws largely from the Clean Marina Certification requirements established through the Clean Marinas Program (Clean Marinas 2017). Additionally, this plan is consistent with the U.S. Environmental Protection Agency's *National Management Measures to Control Nonpoint Source Pollution from Marinas and Recreational Boating* (USEPA 2001) and the *California Clean Marina Toolkit* (Gordon and Matuk 2004).

This plan will be continuously updated, as needed, based on site-specific factors within the overall context of the project location, environment, and needs of the marina and its tenants. A copy of the current Water Quality Management Plan will be available at the dock master's office and at all dock entrances and will be included with all slip lease agreements.

2 Boat Cleaning Management Measures

Preventing the entry of chemicals from boat cleaners, cleaning solvents, and antifoulant paint into marina waters is the most direct way to prevent harm to the aquatic environment from boat cleaning products. This management measure addresses pollutants associated with cleaning agents (e.g., detergents, solvents, and degreasing agents), residues resulting from displacement of coatings from vessel surfaces, and sediments resulting from washing operations. Adherence to these BMPs will minimize the risk of discharging cleaning compounds, paint and varnish residues, and contaminated sediments into the environment.

General BMPs proposed for boat cleaning are as follows:

- Marina users should not perform in-water hull scraping or any abrasive process that removes paint underwater.
- Liquid wastes should not be intentionally discharged onto the ground nor allowed to enter storm drains or waterbodies.
- Tarps and vacuums should be used to collect solid wastes produced by cleaning and repairing boats. No waste should enter the water.

2.1 Topside Boat Maintenance and Cleaning

BMPs proposed for topside boat maintenance and cleaning are as follows:

- Reduce use of toxic cleaning product
 - Only detergents and cleaning components that are designated by the manufacturer as phosphate-free and biodegradable should be used, and the amounts used should be minimized. Detergents containing ammonia, sodium hypochlorite, chlorinated solvents, petroleum distillates, or lye are prohibited.
 - Boaters should reduce the need for boat soaps by scrubbing and rinsing with freshwater after each trip.
 - Canvas boat covers should be used to keep boats clean between trips and to reduce the amount of cleaning needed.
 - Spills and debris should be contained using tarps or other measures.
 - Debris should be collected using vacuums or brooms.
- Conduct spill-proof cleaning and maintenance activities
 - Maintenance work should be conducted aboard boats, not on the docks or over the water.
 - Paints, varnish, epoxy, and other products should be mixed over a tarp or in a drip pan to catch spills and drips. Absorbents should be kept nearby to wipe up spills.
 - Product containers should be tightly sealed when not in use to reduce spills.
 - Scuppers should be plugged to contain spills.

- Minimize emissions from surface preparation
 - Tarps or visquine (sheet plastic) should be used to catch and control falling debris. Boaters should frequently vacuum or sweep to prevent discharge of debris into the water.
 - For small jobs conducted in water, tarps or visquine should be attached from boat to dock to catch debris. Boat should be reversed in the slip to work on the other side.
 - Sanding dust should be disposed of in the trash.
 - Scuppers should be plugged to contain dust, debris, and spills.

2.2 Underwater Boat Hull Cleaning

BMPs for underwater boat hull cleaning are as follows:

- Use less toxic hull paints and antifouling strategies
 - An environmentally friendly antifouling strategy should be considered (i.e., combining the use of less toxic paints and bottom coatings with mechanical means to control growth). Less toxic bottom coatings provide alternatives to soft sloughing paints that release heavy metals.
 - Properly functioning antifouling paint will repel all hard growth and requires only occasional light wiping with a soft cloth to remove slime. Aggressive cleaning of antifouling paint using tools, such as scrubbing pads and powered rotary brushes, will significantly shorten the effective life of the paint and should be avoided.
 - In-water boat hull washing is only permitted by hand.
 - In-water hull scraping or any process that occurs under water and results in the removal of paint from boat hulls is prohibited.
 - Regular hull cleaning and maintenance is encouraged to reduce the build-up of hard marine growth and eliminate the need for hard scrubbing. Regularly scheduled gentle cleaning will also increase the effectiveness of the antifouling hull paint and extend its useful life.
 - Hull cleaning should be performed in accordance with the manufacturer's recommendations for the type of hull coating or bottom paint.
 - Zinc anodes should be taken back to shore and recycled or disposed of properly.

3 Invasive Species Management Measure

Boats can carry invasive species on the hull, bilges, bait tanks, and seawater systems. Aquatic species (such as quagga and zebra mussels) are hard to control and can harm native marine life, damage structures and shorelines, and clog water lines.

Implementing the following BMPs will limit the spread of invasive species:

- Live wells, bilge water, and transom wells should be drained before leaving the vicinity of boat use.
- After leaving the water, boat and boat accessories should be inspected, and any plants or animals found should be disposed of by placing them in the garbage bin.
- Bait buckets should be emptied on land, never into the water.
- Live fish or other organisms should not be dumped from one body of water into another one.
- Boat, tackle, downriggers, and trailer should be washed with hot water.
- Water should be flushed through the boat motor's cooling system and other parts of the boat that normally get wet. If possible, let everything dry for 5 days in the hot sun before using the boat in another body of water.

4 Solid and Liquid Waste Management Measures

The purpose of this management measure is to prevent solid waste from polluting surface waters. Solid waste can collect at marinas, yacht clubs, and boat ramp sites and enter surface waters if litter is not continuously picked up. Final locations of the trash and recycling receptacles will be determined at a later time.

BMPs proposed for solid and liquid waste are as follows:

- All trash, recyclables, and hazardous wastes or potential water contaminants—including old gasoline or gasoline with water, absorbent materials, oily rags, lead acid batteries, antifreeze, waste diesel, kerosene, and mineral spirits—should be disposed of in the separate trash containers and in a proper manner. These materials should not at any time be disposed of in the water or gutter.
- Plastics and trash should not be dumped overboard.
- All containers and trash should be properly placed onboard to prevent them from being blown overboard.
- Monofilament fishing line should be returned to recycling bins at the marina or local tackle shop or sent directly to the Berkley Recycling Center (1900 18th Street, Spirit Lake, Iowa 51360-1099).
- Recyclable hazardous waste should be segregated from other waste and taken to a hazardous waste disposal facility to be recycled. Recyclable hazardous waste includes lead-acid batteries, used oil, oil filters, antifreeze, and zinc anodes.

5 Petroleum Control Management Measures

Fuel can be easily spilled into surface waters from the fuel tank air vent while fueling a boat (if overfilling), and oil can be easily discharged during bilge pumping. Because of gasoline's flammability, spills are also a safety problem. Awareness of the issues associated with boat engines and their maintenance is important, because engines are potential sources of nonpoint source pollution and their operation and maintenance have the potential to affect marina waters. Implementation of the BMPs outlined below can minimize the entry of petroleum from fueling and bilge pumping into surface waters.

BMPs proposed for petroleum control are as follows:

- Perform preventive engine maintenance
 - Boaters should practice preventive engine maintenance and should use oil absorbents in the bilge and under the engine to prevent oil and fuel discharges. Oil absorbent materials should be examined at least once a year and replaced as necessary. Used oil absorbents are hazardous waste in California and must be disposed of in accordance with hazardous waste disposal regulations.
 - Boaters should regularly inspect and maintain engines, seals, gaskets, lines, and hoses in order to prevent oil and fuel spills. The use of soaps that can be discharged by bilge pumps is discouraged.
 - U.S. Coast Guard-approved alcohol-resistant fuel lines should be used.
 - Drip pans should be installed under all equipment that might leak.
 - Use of solvents or toxic chemicals to clean engine parts should be minimized. Use mechanical means (such as hand-scraping caked oil) or less toxic solvents (water-based). Do not let solvent run into the bilge.
 - Fluids should be transferred and removed with care, using funnels, pumps, and absorbents to eliminate drips and spills and to keep the bilge area clean.
- Conduct bilge care and prevent oil spills
 - If the bilge needs more extensive cleaning (e.g., due to spills of engine fuels, lubricants, or other liquid materials), boaters are encouraged to use preventive engine maintenance, oil absorbents, bilge pump-out services, or steam cleaning services as much as possible to clean oily bilge areas.
- Report oil and chemical spills
 - Soaps should not be applied to disperse the sheen if a spill is noticed (it is illegal).
 - Spills of oil or chemicals should be reported to (800)424-8802, (800) OILS911, and to the marina office.
 - Oil changes should be spill proofed, and used oil recycled.

- When changing oil, a closed system—a portable vacuum oil change pump drained into a container that can be closed to prevent spills during transfer of oil (available at most marine supply stores)—should be used.
- Used oil should not be mixed with other waste; keep it segregated for recycling.
- Used motor oil, oil filters, and fuel filters should be recycled at a used oil recycling facility.
- Oil-only absorbents should be kept on hand to wipe up spills.
- Saturated oil-absorbents are hazardous wastes and should be disposed of at the marina, the fuel dock, or at a hazardous waste disposal facility.
- Use safe, spill-proof fueling practices
 - Motors, lights, and electrical equipment should be turned off. Cigarettes and any other sources of ignition should be extinguished.
 - Fuel-soaked absorbents should be kept away from sources of ignition. Doors, hatches, ports, and entryways should be kept closed and blowers turned off.
 - Nozzle contact should be maintained with the fill pipe to prevent static spark and spills.
 - The automatic shut-off nozzle should not be relied on to prevent spills; they do not shut off in time.
 - The capacity of the tank should be known; leave the tank at least 5 percent empty because fuel expands.
 - An absorbent sheet should be held under the nozzle to catch drips, and fuel-soaked absorbents should be properly disposed of as hazardous waste.

BMPs for fueling are as follows:

- Fueling built-in tanks
 - Tanks should be filled slowly to prevent overflows from the air vent; avoid “topping off” the tank.
 - A fuel spill container should be attached to cover the air vent and catch spills (if available).
 - A fuel-air separator should be installed in air vent line to prevent spills or “splash back.”
 - When fueling, hands should be kept at the air vent (or listen) as air gushes when the tank is nearly full.
 - At the end of boating season, tanks should be left full to reduce corrosion and condensation. Fuel stabilizer should be added to prevent stale gas.
- Fueling outboard engines
 - Fuel on land whenever possible.
 - Funnels should be used when filling portable tanks or spill-proof portable containers, and oil-only absorbents should be kept on hand to catch spills.
 - Fuel tanks should be kept empty during long periods of inactivity to prevent stale gas.

6 Public Education Management Measures

Public education is one of the most effective ways to reduce pollution from recreational boating in and around marinas. A boating public that understands the causes and effects of pollution is more likely to want clean waters and healthy aquatic environments. The marina owner must effectively convey information to tenants, contractors, and other individuals visiting the marina to successfully implement this management measure.

Recommended BMPs for public education are as follows:

- *Use signs to inform marina patrons of appropriate clean boating practices.* Interpretive and instructional signs positioned at key locations in the marina can be a key method of providing information to the boating public.
- *Establish bulletin boards for environmental messages and idea sharing.* Bulletin boards are a form of signage, and they allow marinas to post recent or new information for the benefit of their patrons. They are convenient places to post notices about the availability of dustless sanders for rent, environmentally friendly cleaners and antifouling paints, new practices and programs at the marina for reducing pollution, water quality monitoring results, how to maintain an engine to keep emission output low, or any other positive clean boating message.
- *Hand out pamphlets or flyers, send newsletters, and add inserts to bill mailings with information about how recreational boaters can protect the environment and have clean boating waters.* Written materials can be made available at the marina office, supply store, or other places frequently visited by boaters or included with bills mailed to patrons, new tenants, and each year to repeat tenants.
- *Implement Dockwalker Program.* The Clean Marinas Program encourages marinas to have their staff become Dockwalkers or participate in a similar program. Dockwalkers are trained in teaching boaters environmentally sound boating habits. Dockwalkers distribute free educational materials (Boater Kits) to boaters and share information about clean boating practices and the location of services that support clean boating efforts.
- *Educate marina staff to do their jobs in an environmentally conscious manner and to be good role models for marina patrons.*
- *Provide facility contract language that promotes tenant use of certain areas and clean boating techniques when maintaining their boats.* The contract should ensure that tenants will comply with the marina's BMPs. The contract language should also outline enforcement provisions, including eviction from the marina and notice of possible civil or criminal fines and/or penalties, to assure compliance with this program by all marina tenants.

7 Conclusion

This Water Quality Management Plan outlines the management measures for the proposed Project. As implemented, the plan will control adverse impacts to water quality related to long-term use of the marina. This plan will be refined as necessary based on location, environment, design, and needs of the marina and its tenants.

8 References

Clean Marinas, 2017. Clean Marinas Program. Accessed on June 27, 2017. Available from:
<http://www.cleanmarina.org/thecleanmanual.html>.

Gordon, M.F. and Matuk, V., 2004. *California Clean Marina Toolkit*. May 2004.

USEPA (U.S. Environmental Protection Agency), 2001. *National Management Measures to Control Nonpoint Source Pollution from Marinas and Recreational Boating*. USEPA 841-B-01-005. November 2001.

Appendix F

Water Supply Assessment



September 24, 2019

Catherine Payne, Acting Development Planning Manager
City of Oakland
250 Frank H. Ogawa Plaza, Suite 2214
Oakland, CA 94612

Re: Water Supply Assessment – Revised Brooklyn Basin Project

Dear Ms. Payne:

This letter is in response to your request dated July 25, 2019, for water agency consultation (Enclosure 1) concerning the Water Supply Assessment (WSA) for the Revised Brooklyn Basin Project (Project), located in the City of Oakland (City), which is within East Bay Municipal Utility District's (EBMUD's) Ultimate Service Boundary. EBMUD appreciates the opportunity to provide this response.

On June 7, 2004, EBMUD received a request from the City for a WSA for the Project (formerly known as the Oak to Ninth Avenue Mixed Use Development Project). Pursuant to Sections 10910-10915 of the California Water Code (SB-610), EBMUD's Board of Directors approved the WSA and provided the City a written response to the WSA on August 10, 2004 (see Enclosure 2). In the approved 2004 WSA, the estimated demand for the Project (consisting of 3,100 dwelling units, 200,000 square feet of ground-floor commercial space, 3,500 structured parking spaces, and approximately 27 acres of open space) was approximately 640,000 gallons per day (GPD). The City is proposing an increased development consisting of 3,700 multi-family dwelling units, 200,000 square feet of ground-floor commercial space, 3,500 structured parking spaces, and approximately 30 acres of open space.

Pursuant to Sections 10910-10915 of the California Water Code, the Project meets the threshold requirement for an assessment of water supply availability based on the amount of water this Project would require, which is greater than the amount of water required by a 500-dwelling-unit project.

Please note this WSA addresses the issue of water supply only and is not a guarantee of service; future water service is subject to the rates and regulations in effect at that time.

Project Demand

The water demand for the Project is accounted for in EBMUD's water demand projections, as published in EBMUD's Urban Water Management Plan (UWMP) 2015 (Enclosure 3). EBMUD's water demand projections account for anticipated future water demands within

EBMUD's service boundaries and for variations in demand-attributed changes in development patterns. The historical water use in the Project area is approximately 60,000 GPD. The projected water demand at Project build-out is estimated to be approximately 760,900 GPD.

EBMUD's demand projections indicate both densification and land use changes in a few existing land use classifications, including commercial and residential land use areas. These changes increase demand for EBMUD water. EBMUD's UWMP 2015 projects water demands over time, accounting for estimated variations in demand usage minus conservation and recycled supply sources, as noted in the UWMP 2015, Table 4-1, Mid-Cycle Demand Projections (Table 1). Typically, EBMUD prepares a full demand study every ten years; the most recent version, the 2040 Demand Study, was completed in 2009. For planning purposes, water demands are estimated in five-year increments, but it is recognized that actual incremental amounts may occur stepwise in shorter time increments. An increase in usage by one customer in a particular customer class does not require a strict gallon-for-gallon increase in conservation by other customers in that class, as, in actuality, the amount of potable demand, conservation and recycled water use EBMUD-wide will vary somewhat. In 2014, EBMUD prepared the Mid-Cycle Demand Assessment (MCDA) in order to assess any significant effects on metered water consumption caused by the 2008-2010 drought, and the economic downturn that affected growth in the Bay Area. As part of the MCDA, EBMUD reviewed recently updated city and county general plans for significant changes since the 2040 Demand Study, and held meetings with representatives from the cities of Alameda, Oakland, Richmond, and San Ramon. The MCDA concluded that, while the cities and counties might reach their build-out goals later than originally anticipated, they would still reach these goals by 2040. Accordingly, the MCDA validated the 2040 Demand Study, as demands are expected to gradually increase back to 2040 projected levels as development and water use return to pre-drought and pre-recession conditions. EBMUD plans to complete another comprehensive demand study in 2019 with a long-term horizon of 2050. As part of the demand study, EBMUD will reach out to each city and county in the service area to ask about projected development and future land-use changes. The study results will be incorporated into the UWMP 2020.

Table 1
Mid-Cycle Demand Projections (UWMP 2015, Table 4-1)

TABLE 4-1	MID-CYCLE DEMAND PROJECTIONS					
	AVERAGE ANNUAL DEMAND (MGD)	2015	2020	2025	2030	2035
PROJECTED TOTAL DEMAND	232	267	276	290	304	312
CONSERVATION ¹	-33	-39	-44	-51	-57	-62
NON-POTABLE WATER ^{1,2}	-9	-11	-14	-17	-18	-20
PLANNING LEVEL OF DEMAND	190	217	218	222	229	230

1 See Chapters 6 and 7 for more discussion of water recycling and conservation, respectively.
2 Non-potable water includes recycled water and raw water projects.

Project Area

The Project is located along the Oakland Estuary in the City. The Project is bounded by Embarcadero Road to the north, 10th Avenue to the east, Oakland Estuary to the south, and Fallon Street to the west.

The Project area consists of approximately 62 acres. At build-out, the Project will include 3,700 dwelling units, 200,000 square feet of ground-floor commercial space, 3,500 structured parking spaces, and approximately 30 acres of open space.

EBMUD Water Demand Projections

Since the 1970s, water demand within EBMUD's service area has ranged from 200 to 220 million gallons per day (MGD) in non-drought years. Section 4.1 of the UWMP 2015 outlines past and current EBMUD water demand, including Figure 4-1, which shows historic water use (including metered and unmetered demands) within EBMUD's service area along with the number of customer accounts. The 2040 water demand forecast of 312 MGD for EBMUD's service area can be reduced to 230 MGD with the successful implementation of water recycling and conservation programs, as outlined in the UWMP 2015. Current demand is lower than estimated in the MCDA as a result of the recent multi-year drought. This is because the planning level of demand may differ from the actual demand in any given year due to water use reductions that typically occur during droughts. After droughts, a rebound effect is expected wherein demand rises back to projected levels. Thus, the MCDA still reflects a reasonable expectation for demand in year 2040, as the demands are expected to gradually increase back to 2040 projected demand levels as development and water use return to pre-drought and pre-recession conditions. The proposed Project's future development and operations will not change EBMUD's 2040 demand projection.

EBMUD Water Supply, Water Rights, and the UWMP 2015

EBMUD has water right permits and licenses that allow for delivery of up to a maximum of 325 MGD from the Mokelumne River, subject to the availability of Mokelumne River runoff and the senior water rights of other users. EBMUD's position in the hierarchy of Mokelumne River water users is determined by a variety of agreements between Mokelumne River water right holders and the terms of the appropriative water right permits and licenses.

Conditions that could, depending on hydrology, restrict EBMUD's ability to receive its full entitlement include:

- Upstream water use by senior water right holders.
- Downstream water use by riparian and senior appropriators and other downstream obligations, including protection of public trust resources.
- Variability in precipitation and runoff.

During prolonged droughts, the Mokelumne River supply cannot meet EBMUD's projected customer demands. To address this, EBMUD has completed construction of the Freeport Regional Water Facility and the Bayside Groundwater Project Phase 1, which are discussed below in the Supplemental Water Supply and Demand Management section of this assessment. EBMUD has obtained and continues to seek supplemental supplies.

The UWMP 2015, adopted on June 28, 2016, by EBMUD's Board of Directors under Resolution No. 34092-16, is a long-range planning document used to assess current and projected water usage, water supply planning, and conservation and recycling efforts. EBMUD's water supply sources are discussed in Section 1.5.1 of the UWMP 2015. EBMUD's main water supply is the Mokelumne River, and EBMUD has rights to receive up to 325 MGD of water from this source subject to the availability of runoff, senior water rights of other users, and downstream fishery flow requirements. EBMUD also has a Long-Term Renewal Contract (Contract No. 14-06-200-5183A-LTR1) with the United States (U.S.) Bureau of Reclamation to receive water from the Central Valley Project (CVP) through the Freeport Regional Water Facility in years when EBMUD's water supplies are relatively low (for more details, see Section 3.3.2 of the UWMP 2015). During some dry years, EBMUD may purchase water transfers to help meet customer demands. Section 5.1 of the UWMP 2015 discusses EBMUD's water transfer program.

EBMUD maintains a biennial budget and five-year capital improvement program to optimize investments and maximize drinking water quality and the reliability, safety, flexibility, and overall efficiency of the water supply system. EBMUD's most recently adopted budget, which includes capital expenditures for the delivery of water supplies to its customers, can be found at <http://www.ebmud.com/about-us/investors/budget-and-rates/>.

EBMUD complies with applicable local, state, and federal regulations in the operation of its water supply system. Figure 1-4 of the UWMP 2015 illustrates the numerous local, state, and federal agencies that may regulate EBMUD's facilities and operations.

A summary of EBMUD's demand and supply projections, in five-year increments, for a 25-year planning horizon is provided in UWMP 2015, Table 4-5, Preliminary EBMUD Baseline Supply and Demand Analysis (Table 2).

EBMUD's evaluation of water supply availability accounts for the diversions of both upstream and downstream water right holders and fishery releases on the Mokelumne River. Fishery releases are based on the requirements of a 1998 Joint Settlement Agreement (JSA) between EBMUD, U.S. Fish and Wildlife Service, and the California Department of Fish and Wildlife. The JSA requires EBMUD to make minimum flow releases from its reservoirs to the lower Mokelumne River to protect and enhance the fishery resources and ecosystem of the river. As this water is released downriver, it is, therefore, not available for use by EBMUD's customers.

Table 2
Preliminary EBMUD Baseline Supply and Demand Analysis (UWMP 2015, Table 4-5)

SUPPLY AND DEMAND COMPARISON - NORMAL YEAR (MGD)		2015	2020	2025	2030	2035	2040
	MOKELUMNE SYSTEM	>190	>217	>218	>222	>229	>230
	DEMAND TOTALS	190	217	218	222	229	230
	DIFFERENCE	0	0	0	0	0	0
DRY YEAR RESULTS FROM EBMUDSIM (MGD)		2015	2020	2025	2030	2035	2040
SINGLE DRY YEAR OR FIRST YEAR OF MULTI-YEAR DROUGHT	MOKELUMNE SYSTEM	145	169	170	173	179	179
	CVP SUPPLIES ²	36	35	35	35	35	35
	BAYSIDE ³	0	0	0	0	0	0
	SUPPLY TOTALS	181	204	205	209	214	215
	PLANNING LEVEL DEMAND ¹	190	217	218	222	229	230
	RATIONING ⁴	5%	6%	6%	6%	7%	7%
	DEMAND TOTALS	180	203	204	208	213	214
	NEED FOR WATER (TAF)⁵	0	0	0	0	0	0
SECOND YEAR	MOKELUMNE SYSTEM	81	103	103	107	112	113
	CVP SUPPLIES ²	71	71	71	71	71	71
	BAYSIDE ³	0	0	0	0	0	0
	SUPPLY TOTALS	152	174	174	178	183	184
	PLANNING LEVEL DEMAND ¹	190	217	218	222	229	230
	RATIONING ⁴	20%	20%	20%	20%	20%	20%
	DEMAND TOTALS	152	174	175	178	184	185
	NEED FOR WATER (TAF)⁵	0	0	0	0	0	0
THIRD YEAR	MOKELUMNE SYSTEM	111	132	132	125	120	104
	CVP SUPPLIES ²	40	40	40	40	40	40
	BAYSIDE ³	1	1	1	1	1	1
	SUPPLY TOTALS	152	174	173	166	162	145
	PLANNING LEVEL DEMAND ¹	190	217	218	222	229	230
	RATIONING ⁴	20%	20%	20%	20%	20%	20%
	DEMAND TOTALS	152	174	174	178	183	184
	NEED FOR WATER (TAF)⁵	0	0	2	13	24	48

1. Planning Level of Demand accounts for projected savings from water recycling and conservation programs as discussed in Chapters 6 and 7 respectively. Customer demand values are based on the Mid Cycle Demand Assessment, October 2014.
 2. Projected available CVP supplies are taken according to the Drought Management Program Guidelines discussed in Chapter 3.
 3. For the purposes of this modeling effort, it is assumed that the Bayside Groundwater Project would be brought online in the third year of a drought.
 4. Rationing reduction goals are determined according to projected system storage levels in the Drought Management Program Guidelines discussed in Chapter 3.
 5. Need for Water includes unmet customer demand as well as shortages on the Lower Mokelumne River.

The available supply and demand shown in Table 2 were derived from EBMUD’s baseline hydrologic model with the following assumptions:

- Customer demand values are based on the MCDA, and planning-level demands account for projected savings from water recycling and conservation programs.
- EBMUD Drought Planning Sequence assumes water years 1976, 1977, and a modified 1978 hydrology.
- Total system storage is depleted by the end of the third year of the drought.
- EBMUD will implement its Drought Management Program (DMP) when necessary.

- The diversions by Amador and Calaveras Counties upstream of Pardee Reservoir will increase over time, eventually reaching the full extent of their senior rights.
- Releases are made to meet the requirements of senior downstream water right holders and fishery releases, as required by the JSA.
- EBMUD allocation of CVP supply is available the first year of a drought and subsequent drought years, according to the U.S. Bureau of Reclamation's Municipal and Industrial Shortage Policy.
- The Bayside Groundwater Project Phase 1 is available and brought online in the third year of a drought.

The UWMP 2015 concludes that EBMUD has, and will have, adequate water supplies to serve existing and projected demand within the Ultimate Service Boundary during normal and wet years, but that deficits are projected for multi-year droughts. During multi-year droughts, EBMUD may require significant customer water use reductions and may also need to acquire supplemental supplies to meet customer demand.

As discussed under the DMP Guidelines section in Chapter 3 of the UWMP 2015, EBMUD's system storage generally allows EBMUD to continue serving its customers during dry-year events. EBMUD typically imposes water use restrictions based on the projected storage available at the end of September and, based on recent changes to its DMP Guidelines (summarized below), may also implement water use restrictions in response to a State of California mandate. By imposing water use restrictions in the first dry year of potential drought periods, EBMUD attempts to minimize water use restrictions in subsequent years if a drought persists. Throughout dry periods, EBMUD must continue to meet its current and subsequent-year fishery flow release requirements and obligations to downstream agencies.

The UWMP 2015 includes DMP Guidelines that establish the level of water use restrictions EBMUD may implement under varying conditions. Under the DMP Guidelines, water use restrictions may be determined based upon either projected end-of-September Total System Storage (TSS) or water use restriction mandates from the State Water Resources Control Board. When state-mandated water use restrictions exceed the reductions that would otherwise be called for based upon end-of-September TSS, EBMUD's water use reduction requirements may be guided by the applicable state mandates. Under either scenario, while EBMUD strives to keep water use reductions at or below 15 percent, if the drought is severe, mandatory water use reductions could exceed 15 percent.

Despite water savings from EBMUD's aggressive conservation and recycling programs and water use restrictions called for in the DMP Guidelines, supplemental supplies are still needed in significant, severe, and critical droughts. The proposed Project will be subject to the same drought restrictions that apply to all EBMUD customers. In addition, the proposed Project will be subject to EBMUD's regulations aimed at encouraging efficient water use, such as Sections 29 and 31 of EBMUD's Regulations Governing Water Service. Section 29, "Water Use Restrictions," promotes efficient water use by EBMUD customers and prohibits certain uses of potable water. Section 31, "Water Efficiency Requirements," identifies the types of water efficiency requirements (i.e., maximum flow rates for flow control devices) for water service.

Supplemental Water Supply and Demand Management

The goals of meeting projected water needs and increased water reliability rely on supplemental supplies, improving reliability of existing water supply facilities, water conservation, and recycled water programs.

By 2011, EBMUD completed construction of the Freeport Regional Water Facility and the Bayside Groundwater Project Phase 1 to augment its water supply during drought periods. However, additional supplemental supplies beyond those provided through these facilities will still be needed, as noted above. Chapter 5 of the UWMP 2015 describes potential supplemental water supply projects that could be implemented to meet projected long-term water demands during multi-year drought periods.

The Freeport Regional Water Facility became operational in February 2011. EBMUD's ability to take delivery of CVP water through the Freeport Regional Water Facility is based on its Long Term Renewal Contract (LTRC) with the U.S. Bureau of Reclamation. The LTRC provides for up to 133,000 acre feet of CVP supply in a single dry year, not to exceed a total of 165,000 acre feet in three consecutive dry years. Under the LTRC, the CVP supply is available to EBMUD only in dry years when EBMUD's total stored water supply is forecast to be below 500,000 total acre feet on September 30 of each year.

EBMUD is developing the Bayside Groundwater Project in phases to provide a source of supplemental supply in dry years. Construction of the first phase (Bayside Groundwater Project Phase 1) was completed in 2010, allowing EBMUD to inject treated potable water into a deep aquifer in the South East Bay Plain Groundwater Basin for later extraction, treatment, and use during severe droughts. A permit from the Department of Public Health is required before the groundwater can be extracted and treated for municipal use. As described in Chapter 4 of the UWMP 2015, EBMUD's drought planning calls for using the Bayside Groundwater Project Phase 1 during the third year of multi-year droughts to provide up to 1 MGD of water to meet customer demands. Additional information on the Bayside Groundwater Project can be found in Section 5.3 and Appendix E of the UWMP 2015.

Chapter 5 of the UWMP 2015 also lists other potential supplemental water projects, including Northern California water transfers, Bayside Groundwater Project Expansion, expansion of Contra Costa Water District's Los Vaqueros Reservoir, and others that could be implemented to meet the projected long-term water supplemental need during multi-year drought periods. The UWMP 2015 identifies a broad mix of projects, with inherent scalability and the ability to adjust implementation schedules for particular components, which will allow EBMUD to pursue the necessary supplemental supplies while minimizing the risks associated with future uncertainties, such as project implementation challenges and global climate change. The Environmental Impact Report that EBMUD certified for the Water Supply Management Program 2040 examined the impacts of pursuing these supplemental supply projects at a program level. Separate project-level environmental documentation will be prepared, as appropriate, for specific components as they are developed in further detail and implemented in accordance with EBMUD's water supply needs.

In addition to pursuing supplemental water supply sources, EBMUD also maximizes resources through continuous improvements in the delivery and transmission of available water supplies and investments in ensuring the safety of its existing water supply facilities. These programs, along with emergency interties and planned water recycling and conservation efforts, would ensure a reliable water supply to meet projected demands for current and future EBMUD customers within the current service area.

Water Conservation and Recycled Water Considerations

The proposed Project presents opportunities to incorporate water conservation measures. Conditions of approval for the implementation of the proposed Project should require that the Project comply with the California Model Water Efficient Landscape Ordinance (Division 2, Title 23, California Code of Regulations, Chapter 2.7, Sections 490 through 495). EBMUD staff would appreciate the opportunity to meet with the City to discuss conservation measures. This meeting will explore early opportunities to expand water conservation via EBMUD's conservation programs and best management practices applicable to the Project.

Conservation strategies will be required to achieve water use reduction goals and restrictions, including compliance with Sections 29 and 31, described above, of EBMUD's Regulations Governing Water Service, and the Water Conservation Act of 2009. The Water Conservation Act of 2009 sets an overall goal of reducing per capita urban water use by 20 percent by December 31, 2020.

The Project area lies near the recycled water pipeline infrastructure of the East Bayshore Recycled Water Project service area. Per EBMUD Policy 9.05 and Section 30, "Nonpotable Water Service" of EBMUD's Regulations Governing Water Service, the project sponsor, at their expense, will be required to use non-potable water, including recycled water, for non-potable purposes including, but not limited to, landscape irrigation, commercial and industrial processes (e.g., cooling tower water), and toilet and urinal flushing in non-residential buildings. The project sponsor should work with EBMUD to determine the feasibility and cost effectiveness of extending new recycled water mains to the Project site, at the project sponsor's expense, based on the anticipated Project water demand associated with non-potable purposes. The City and project sponsor should maintain continued coordination and consultation with EBMUD regarding the required use of recycled water as they plan and implement various components of the Project.

The Project sponsor should contact Jennifer L. McGregor, Senior Civil Engineer, at (510) 287-1030 for further information.

Sincerely,



David J. Rehnstrom

Manager of Water Distribution Planning Division

DJR:LAM:JLM:sjp

sb19_155b_Revised Brooklyn Basin Project_WSA_Letter

Catherine Payne, Acting Development Planning Manager

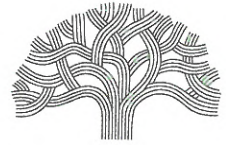
September 24, 2019

Page 9

Enclosures: 1. Letter of Request for Water Supply Assessment dated July 25, 2019
2. EBMUD's Response to City's June 3, 2004 Water Supply Assessment Request
3. EBMUD Urban Water Management Plan 2015

cc: Board of Directors w/o Enclosure 3

CITY OF OAKLAND



DALZIEL BUILDING • 250 FRANK H. OGAWA PLAZA, SUITE 2114 • OAKLAND, CALIFORNIA 94612-2032

Planning & Building Department
Bureau of Planning

(510) 238-3911
FAX (510) 238-4730
TDD (510) 238-3254

July 25, 2019

Mr. David J. Rehnstrom
Manager of Water Distribution Planning
East Bay Municipal Utility District
375 11th Street
Oakland, CA 94607

RECEIVED
AUG 06 2019
WATER SERVICE PLANNING

Re: Request for a Water Supply Assessment for the Revised Brooklyn Basin Project

Dear Mr. Rehnstrom:

Pursuant to Senate Bill (SB) 610 (Water Code section 10910), the City of Oakland requests that the East Bay Municipal Utility District (“EBMUD”) prepare a water supply assessment for a proposed amendment to the approved Brooklyn Basin Project to increase the number of dwelling units by 600 units (from a total of 3,100 to 3,700 units). The Notice of Preparation for the supplemental environmental impact report that the City is preparing for the Project, which has a full Project description, is attached to this letter and available on our website, at <https://cao-94612.s3.amazonaws.com/documents/NOP-092118-BB-SEIR.pdf>. A copy of EBMUD’s water supply assessment on the original project is also available on the City’s Brooklyn Basin website page as Exhibit E-1 to the Draft EIR.

Please let me know if you need additional information to provide the water supply assessment.

Sincerely,

Catherine Payne
Acting Development Planning Manager
City of Oakland



CITY OF OAKLAND

Bureau of Planning

250 Frank H. Ogawa Plaza, Suite 3315, Oakland, California, 94612-2032

**NOTICE OF PREPARATION (NOP) OF A
SUPPLEMENTAL ENVIRONMENTAL IMPACT REPORT (SEIR) FOR THE
BROOKLYN BASIN (“FORMERLY OAK TO NINTH MIXED USE DEVELOPMENT”) PROJECT**

The City of Oakland’s Bureau of Planning is preparing a Draft Supplemental Environmental Impact Report (“SEIR”) for proposed modifications to the Oak to Ninth Mixed Use Development analyzed in the 2006 EIR and 2009 Recertified EIR prepared and published by the City of Oakland (City), and subsequently renamed and approved as the Brooklyn Basin Project, which is comprised of the Brooklyn Basin Planned Unit Development (PUD) and referred to herein as “approved project.” The City is requesting comments on the scope and content of the Draft SEIR. The City has **not** prepared an Initial Study; the Draft SEIR will address the potential environmental effects of the modifications to the approved project per the requirements of the California Environmental Quality Act (CEQA) statutes (Public Resources Code [PRC] Section 21000 et seq.) and the CEQA Guidelines (California Code of Regulations 15000 et seq.).

The City of Oakland is the Lead Agency for the project and is the public agency with the greatest responsibility for considering approval of the project and/or carrying it out. This notice is being sent to Responsible Agencies and other interested parties. Responsible Agencies are those public agencies, besides the City of Oakland, that have a role in considering approval and/or carrying out the project. When the Draft SEIR is published, it will be sent to all Responsible Agencies and to others who respond to this NOP or who otherwise indicate that they would like to receive a copy.

Responses to this NOP that address the scope of the Draft SEIR and any related questions or comments should be directed in writing to: **Catherine Payne, Acting Development Planning Manager, City of Oakland Bureau of Planning, 250 Frank H. Ogawa Plaza, Suite 2214, Oakland, CA 94612; (510) 238-6168 (phone); (510) 238-3254 (fax); or cpayne@oaklandca.gov.** Responses to the NOP must be received at the above mailing or e-mail address by 5:00 p.m. on **October 22, 2018**. Please reference Case File Number **PUD06010-R02-ER01** in all correspondence. In addition, comments on the scope of the Draft SEIR will be received at the SEIR Scoping Meetings to be held before the City Planning Commission, as noticed below.

The proposed modifications to the approved project are described in greater detail below. Commenters should focus comments on potential impacts of the proposed modifications to the approved project on the physical environment; ways in which potential adverse effects resulting from the modifications to the approved project might be minimized; and alternatives to the project with the proposed modifications, in light of the Revised SEIR’s purpose to provide useful and accurate information about such factors.

To the extent that public comments received on the scope and adequacy of the 2009 Recertified EIR apply to the modified project, the City will continue to consider such comments during the preparation of the Revised Draft SEIR.

EIR SCOPING MEETING:

The **City of Oakland Planning Commission** will conduct a public scoping meeting on the Draft SEIR for modifications to the Brooklyn Basin Project on **October 17, 2018 at 6:00 p.m.** in the Oakland City Council Chamber in **Oakland City Hall, 1 Frank H. Ogawa Plaza, Oakland, CA.**

PROJECT TITLE: Brooklyn Basin Project (Case File No. PUD06010-R02-ER01; State Clearinghouse Number: 20062013)

PROJECT LOCATION: Approximately 64.2 land acres bound by Embarcadero Road (north), the Oakland Estuary (south), Fallon Street (west), and approximately 10th Avenue (east), in addition to 8 acres of submerged land (see **Figure 1**). Assessor Parcel Numbers include 0000-0430-001-02, portion of 0000-0430-001-04, 0000-0460-003, 0000-0460-004, 0000-0465-002, and a portion of 0000-0470-002.

PROJECT SPONSOR: Zarsion-OHP 1, LLC

EXISTING CONDITIONS: The site currently has City of Oakland General Plan designations of Planned Waterfront Development-1 (PWD-4) in the Estuary Policy Plan, and in the Planned Waterfront Zoning District (PWD-4). As of the date of this NOP, the project site is not included in the list of Hazardous Waste and Substances sites in the Department of Toxic Substances Control (DTSC) EnviroStor database, one of the lists meeting the “Cortese List” requirements (<http://www.calepa.ca.gov/sitecleanup/corteseelist/>, accessed September 4, 2018).

The project was originally approved in five phases: Phases I-IV and Phase Ia, see **Figure 2**. Final Development Plans for Phases I and II construction, including Parcels B, C and F vertical development, have been approved. Construction of Phases I and II has already commenced, including work on the Phase I landside components (Shoreline Park, 9th Avenue Terminal Building) and Phase II site remediation of the project are underway. Notable changes to existing site conditions since publication of the 2009 Recertified EIR and potentially relevant to the CEQA analysis of the proposed modifications include demolition of previous structure, site remediation, site grading, Embarcadero improvements (bridge construction, established bike lanes), the aforementioned Phase I landside development, including approval of an affordable housing project—the vertical development approved for Parcel F.

BACKGROUND: The City certified an EIR for the project in 2006. That EIR was subsequently modified to comply with the Alameda County Superior Court ruling to rescind its 2006 certification and revise the EIR, which the City subsequently recertified in 2009. The approved Brooklyn Basin Project analyzed in the 2006 and 2009 EIRs (referred to collectively as “EIR”) involves development of 3,100 residential units, 200,000 square feet of ground-floor retail/commercial and civic spaces, 29.9 acres of parks and public open space, an existing wetlands restoration area, and improvements and expansion of Clinton Basin marina, see **Figure 3**.

Because an EIR was already recertified for the project, the City is required to determine whether further CEQA environmental review is required for the proposed modifications to the approved project in accordance with PRC Section 21166 and CEQA Guidelines Section 15162. Under these sections, no further environmental review is required unless there are new or substantially more severe impacts of the project than those analyzed in the certified EIR. Because the proposed modifications to the project may result in new and potentially substantially more severe impacts than the original project analyzed in the EIR, the City of Oakland is resuming the CEQA analysis by preparing a SEIR for the modifications.

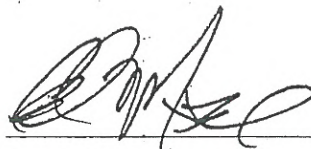
PROJECT DESCRIPTION:

Additional Residential Units: The Project sponsor seeks to amend Phases III and IV of the approved project to allow an additional 600 residential units, for a total of up to 3,700 units. (Phase Ia, the remediation of Estuary Park, would be unaffected.) The modifications proposed to the approved project would accommodate the additional units within the approved building envelopes; no changes to the height, massing or setbacks of the approved project are required or proposed. As anticipated in the original PUD, the allocation of residential units has shifted between certain development parcels since approval of the project, however the current allocation of units on each parcel still results in a total of 3,100 units on the overall project site. It is anticipated that the additional 600 units would be located in Parcels K, L, and M to be developed in project Phases III and IV (of the five phases total), see **Figure 4**. The Project sponsor also seeks amendments to allow the right to relocate one of the approved residential towers, currently contemplated on Parcels H and J, to either Parcel L or Parcel M (resulting in two towers sited on Parcel M). To accommodate the increased density resulting with the modifications to the project, the Project sponsor seeks to amend the General Plan to modify the existing PWD-4 land use classification, and seeks a Zoning Code Amendment to amend the average density of the PWD-4 Zoning District and to increase the total number of units allowed from 3,100 to 3,700. This aspect of the proposed modifications also requires approval of a revised PUD permit and an amendment to the approved Development Agreement (DA) between the Project sponsor and the City.

Marina Expansion: The Project sponsor also seeks to modify the approved project to expand the Brooklyn Basin marina in Clinton Basin to a total 218 slips. The original PUD had approved a total 60 slips in Clinton Basin, therefore the proposed modifications would result in an increase of up to 158 slips compared to the approved project, see Figure 5. The modification would remove and replace the existing Clinton Basin marina, expanding it with 14 additional docks that would wrap along the shoreline between 9th Avenue into Clinton Basin. No changes are proposed to the previously approved upland development, except for main walkway improvements near the 9th Avenue Terminal Building, and a harbormaster office, laundry facilities and boater parking in compliance with the Clean Marina Program. Marina restroom facilities would be located on the ground floor of an approved building fronting Clinton Basin. The modifications to the marina plan would shade or "fill" approximately 114,375 square feet over open water compared to approximately 23,460 square feet of fill previously analyzed; therefore, the modification will result in a net increase of approximately 90,915 square feet the area of fill compared to the original project. No fuel station would be introduced. This proposed marina expansion also requires approval of a revised PUD, a previously approved Final Development Plan, a new conditional use permit as well as a DA amendment.

Landing Dock for Ferry/ Water Taxi Service: The modification to the project also proposes to develop a landing dock at the Brooklyn Basin marina to accommodate an existing water taxi and small-scale ferry service. Initially, the landing dock would be served by limited service, available to project residents and the public, with a service to the San Francisco Ferry Building (Gate B).

ENVIRONMENTAL TOPICS: The following topics will be fully addressed in the Draft SEIR: *aesthetics, air quality and health risk, biological resources, cultural and tribal cultural resources, greenhouse gas emissions, hydrology and water quality, land use and planning, noise and vibration, transportation and traffic, and utilities and service systems.* The following topics will be addressed briefly in the Draft SEIR, to the extent necessary to assess whether the proposed modifications to the approved project would have new or substantially more severe impacts on these topics identified in the certified EIR: *agriculture and forestry resources, hazards and hazardous materials, mineral resources, population and housing, and public services and recreation.* The Draft SEIR will also examine a reasonable range of alternatives to the proposed modifications. The analysis will consider each of the alternatives analyzed in the 2009 EIR, as well as the CEQA-mandated No Project Alternative and other potential alternatives that may reduce or avoid potential environmental effects.

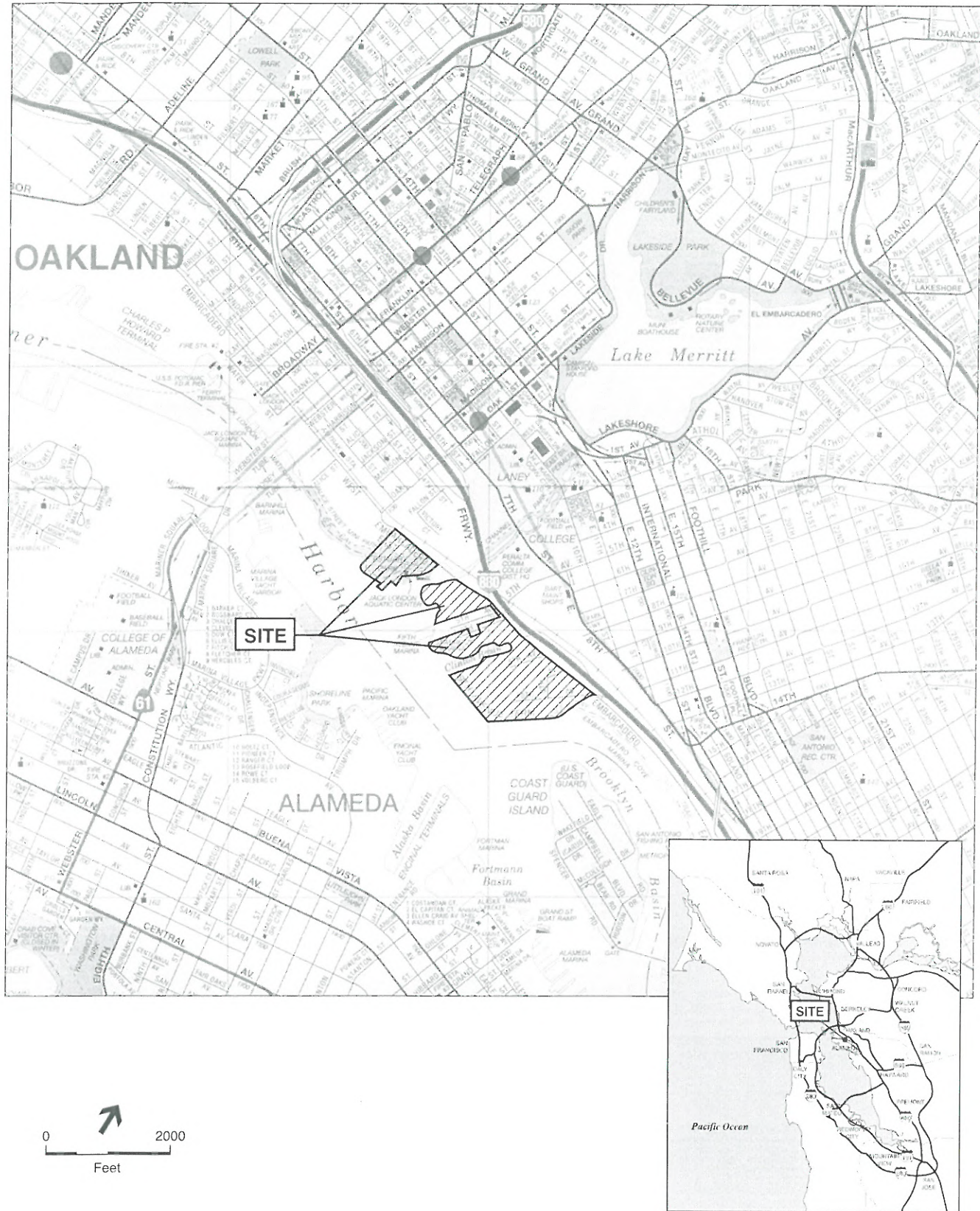


September 21, 2018
Case File Number: PUD06010-R02-ER01

Interim Deputy Planning Director, Bureau of Planning
Environmental Review Officer

Attachments:

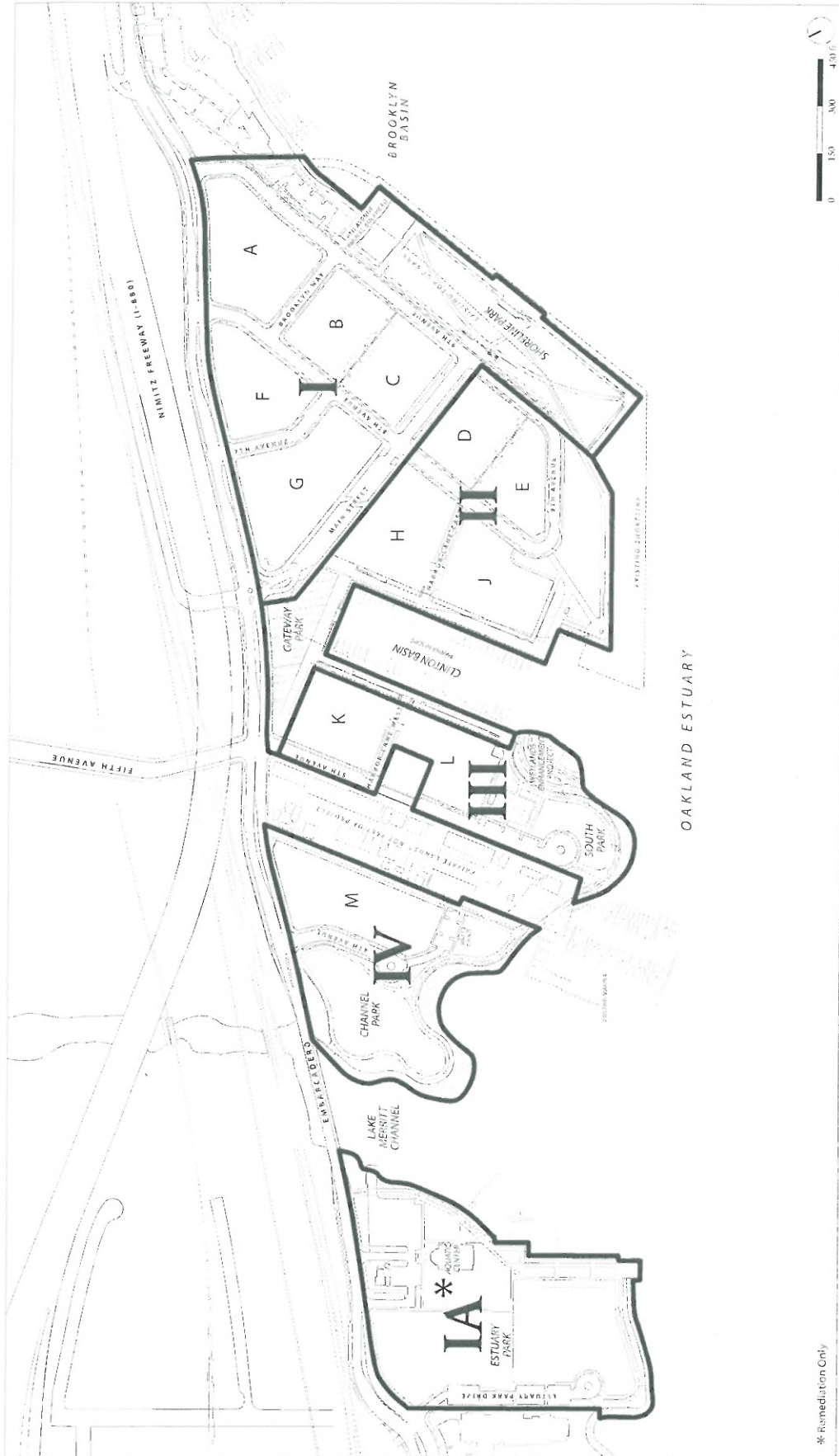
- Figure 1, Location Map
- Figure 2, Phasing Plan, dated 2006 (approved 2009)
- Figure 3, Illustrative Development Plan (PUD), dated 2006 (approved 2009, amended 2014)
- Figure 4a, Approved Development Program and Parcelization Plan, dated 2006 (approved 2009)
- Figure 4b, Approved Enlarged Plan - Clinton Basin Quays, dated 2006 (approved 2009)
- Figure 5, Proposed Modification to the Illustrative Development Plan (PUD), dated 2018



SOURCE: ESA

Brooklyn Basin Project 150431

Figure 1
Location Map



PHASING PLAN

Brooklyn Basin - Oak to 9th Development Plan

Prepared for Oakland Harbor Partners by ROMA Design Group in association with MVE Architects, Moffatt & Nichol and BKF Engineers

OCTOBER 2006



ILLUSTRATIVE DEVELOPMENT PLAN

Brooklyn Basin - Oak to 9th Development Plan

Prepared for Oakland Harbor Partners by ROMA Design Group in association with MVE Architects, Moffatt & Nichol and BKL Engineers

OCTOBER 2006

Figure 3
1.3

Figure 4a 1.4

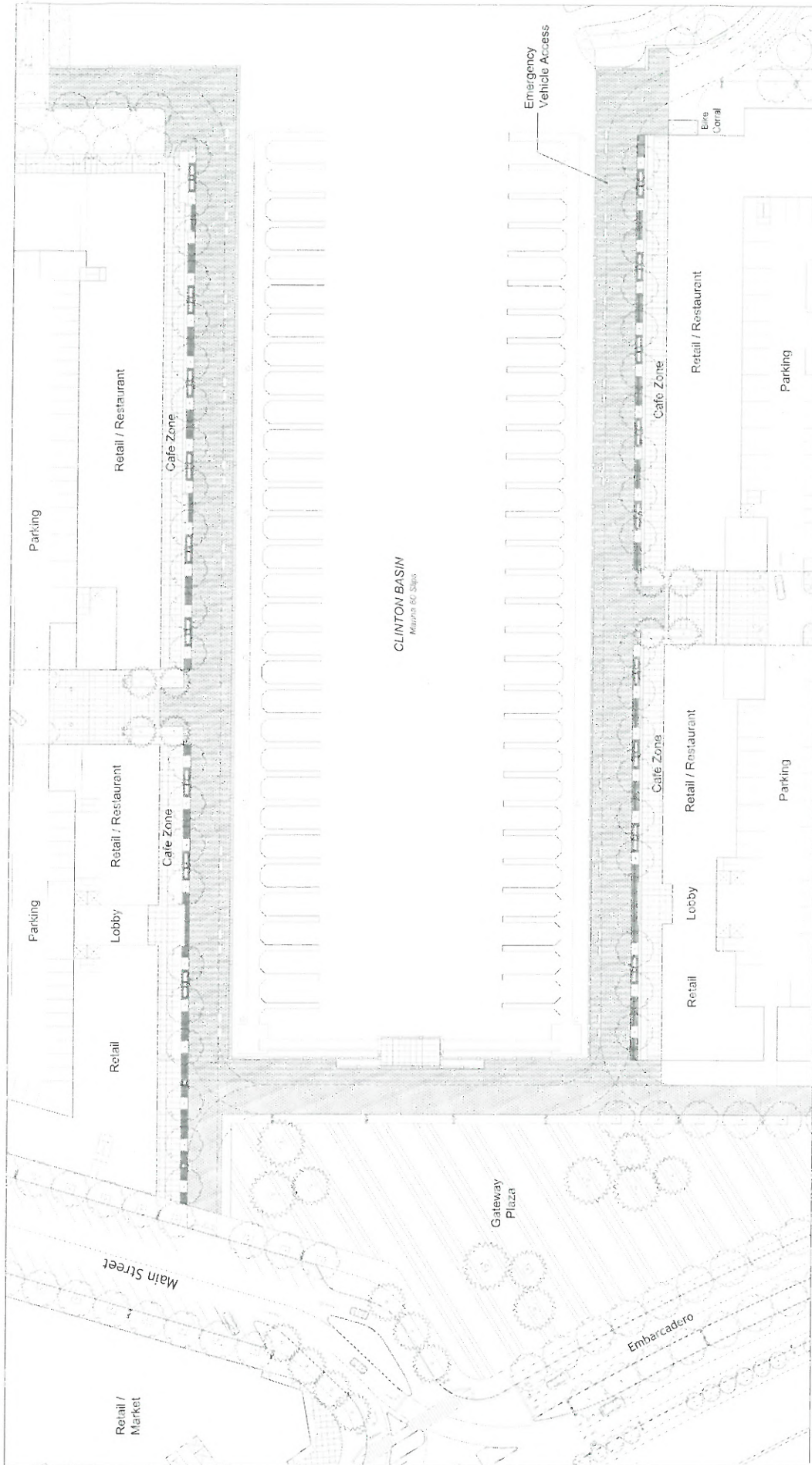


DEVELOPMENT PROGRAM AND PARCELIZATION PLAN

Brooklyn Basin - Oak to 9th Development Plan

Prepared for Oakland Harbor Partners by ROMA Design Group in association with MVI Architects, Molitor & Nichol and BKF Engineers

OCTOBER 2006



ENLARGED PLAN - CLINTON BASIN QUAYS

Brooklyn Basin - Oak to 9th Development Plan

Prepared for Oakland Harbor Partners by ROMA Design Group in association with MVE Architects, Moffatt & Nichol and BKJ Engineers

OCTOBER 2006

Figure 4b 3.7a

SHEET NO
1.4

Figure 5



DEVELOPMENT PROGRAM AND PARCELIZATION PLAN

Brooklyn Basin - Oak to 9th Development Plan

Prepared for Oakland I Harbor Partners by ROMA Design Group in association with MVL Architects, Moffatt & Nichol and BKF Engineers

AMENDED NOVEMBER 5, 2014

PROPOSED MARCH 2018 AMENDMENT



August 12, 2004

Margaret Stanzone, Project Manager
City of Oakland
250 Frank Ogawa Plaza, Suite 3330
Oakland, CA 94607

Dear Ms. Stanzone:

RE: Water Supply Assessment – Oak to Ninth Avenue Mixed Use Development Project

This letter responds to your request of June 3, 2004 for water agency consultation concerning the Oak to Ninth Avenue Mixed Use Development Project (Enclosure 1). The East Bay Municipal Utility District (EBMUD) appreciates the opportunity to provide this response.

Pursuant to Sections 10910-10915 (SB-610) of the California Water Code, the project meets the threshold requirement for an assessment of water supply availability based on the amount of water this project would require, which would be greater than the amount required by a 500 dwelling unit project.

Please note that this assessment addresses the issue of water supply only and is not a guarantee of service, and future water service is subject to rates and regulations in effect at the time.

Project Demand

The water demands for the Oak to Ninth Avenue Mixed Use Development Project area are accounted for in EBMUD's water demand projections as published in EBMUD's 2000 Urban Water Management Plan (UWMP/Enclosure 2). EBMUD's water demand projections account for anticipated future water demands within EBMUD's service boundaries and for variations in demand-attributed changes in development patterns. The current water demand for the existing land uses in the Oak to Ninth Avenue Mixed Use Development Project area is about 60,000 gallons per day (gpd). The projected demand, based on the projected water consumption by the applicant for the project area, is estimated to be 640,000 gpd and is consistent with EBMUD's demand projections that indicate densification of these types of land uses.

Project Area

The Oak to Ninth Avenue Mixed Use Development Project is located along the Oakland Estuary and consists of approximately 62 acres. The project is bounded by Embarcadero

Margaret Stanzione
August 12, 2004
Page 2

Road to the north, Oakland Estuary to the south, Fallon Street to the west and 10th Avenue to the east (see Attachment A).

The project under consideration includes up to 3,100 residential units, 200,000 square feet of ground-floor commercial space, 3,500 structured parking spaces and approximately 27 acres of open space.

EBMUD Water Demand Projections

The water consumption of EBMUD customers has remained relatively level in recent years in spite of population and account growth. Between 1987 and the present, consumption has ranged from a high of approximately 220 million gallons per day (mgd) in 1987 to a low of 170 mgd in 1989. Based on extensive forecasting in EBMUD's Water Supply Management Program (WSMP) and recent land use based demand forecasting, the WSMP forecast for 2020 water demand of 277 mgd can be reduced to 229 mgd with successful water recycling and conservation programs that are in place. The Oak to Ninth Avenue Mixed Use Development Project will not change the EBMUD 2020 demand projection.

EBMUD Water Supply and Water Rights

EBMUD has water rights and facilities to divert up to a maximum of 325 mgd from the Mokelumne River, subject to the availability of Mokelumne River runoff and the prior water rights of other users. EBMUD's position in the hierarchy of Mokelumne River water users is determined by a variety of agreements between Mokelumne River water right holders, the appropriative water rights permits and licenses that have been issued by the State, pre-1914 rights and riparian rights. Conditions that restrict EBMUD's ability to use its 325 mgd entitlement include:

- Upstream water use by prior right holders.
Downstream water use by riparian and senior appropriators and other downstream obligations, including protection of public trust resources.
- Drought, or less than normal rainfall for more than a year.
- Emergency outage.

During periods of drought, runoff from the Mokelumne River is insufficient to supply the 325 mgd entitlement. EBMUD studies indicate that, with its current water supply and the water demands expected in 2020, deficiencies in supply of up to 67 percent could occur during droughts.

EBMUD UWMP

The UWMP, adopted by the Board of Directors in Resolution No. 33242-01, includes planning level analyses at the County- and EBMUD-wide levels for existing

Margaret Stanzione

August 12, 2004

Page 3

and projected water demand. A summary of EBMUD's demand and supply projections in five-year increments is provided in a table (Enclosure 3) from the UWMP. The data reflects the latest actual and forecast values.

EBMUD's evaluation of water supply availability accounts for the diversions of both upstream and downstream water right holders and fishery releases. Fishery releases are based on the requirements of a 1998 Joint Settlement Agreement (JSA) between EBMUD and State and Federal wildlife agencies. The JSA requires EBMUD to make minimum flow releases from its reservoirs to the lower Mokelumne River to benefit the fishery. As this water is released downriver, it is, therefore, not available for use by EBMUD's customers.

The available supply shown in the table (Enclosure 3) in years 1, 2 and 3 of a multiple-year drought was determined by EBMUD's hydrologic model with the following assumptions:

- EBMUD Drought Planning Sequence is used for 1976, 1977 and 1978.
- Total system storage is depleted by the end of the third year of the drought. The diversions by Amador and Calaveras Counties upstream of Pardee Reservoir increase over time.
- Releases are made to meet the requirements of senior downstream water right holders and fishery releases are made according to the JSA.

As discussed under the Drought Management Program section in Chapter 3 of the UWMP, EBMUD's system storage generally allows it to continue serving its customers during dry-year events. EBMUD imposes rationing based on the projected storage at the end of September. By imposing rationing in the first dry year of potential drought, EBMUD attempts to minimize rationing in subsequent years if a drought persists while continuing to meet its current and subsequent-year fishery flow release requirements and obligations to downstream agencies. Table 3-1 in the UWMP summarizes the guidelines for consumer water reduction goals based on system storage.

In the table (Enclosure 3), "Single Dry" year (or Year 1 of "Multiple Dry Years") is determined to be a year that EBMUD would implement Drought Management Program elements at the "moderate" stage with the goal of achieving between 0 to 15 percent reduction in customer demand. Year 2 of Multiple Dry Years is determined to be a year that EBMUD would implement Drought Management Program elements at the "severe" stage with the goal of achieving between 15 to 25 percent reduction in customer demand. In Year 3 of the multiple-year drought, deficiencies from about 48 percent in year 2005 to about 67 percent in year 2020 are forecast to occur. Therefore, a supplemental supply is needed, which is defined by EBMUD as the additional amount of water necessary to limit customer deficiency to 25 percent in a multiple-year drought while continuing to meet the requirements of senior downstream water right holders and the provisions of the 1998 JSA.

Margaret Stanzone
August 12, 2004
Page 4

Supplemental Water Supply and Demand Management

The goals of meeting projected water needs and increased water reliability rely on three components: supplemental supply, water conservation and recycled water.

Chapter 2 of the UWMP describes EBMUD's supplemental water supply project alternatives to meet its long-term water demand. To address the need for a supplemental water supply during droughts, EBMUD signed a contract in 1970 with the Federal government for a supplemental supply from the Central Valley Project (CVP). In 2001, EBMUD certified the environmental documentation amending its CVP contract 14-06-200-5183A, reducing EBMUD's contract from 150,000 acre-feet (AF)/year to an annual entitlement not to exceed 133,000 AF. In 2002, EBMUD signed a Memorandum of Agreement with the City of Sacramento, the County of Sacramento and the U.S. Bureau of Reclamation to study a joint regional water project on the Sacramento River near Freeport. The Draft Environmental Impact Report/Environmental Impact Statement (EIR/EIS) of the Freeport Regional Water Project identifies several regulatory permits and approvals required for the implementation of the project alternatives. These are listed in Table 2-6 of the Freeport Regional Water Project Draft EIR/EIS, July 2003.

Chapter 2 of the UWMP also describes other supplemental water projects, including the development of groundwater storage within EBMUD's service area. EBMUD is studying the environmental impacts of these proposed projects. Specific capital outlay and financing information for these projects are included in EBMUD's FY02-03 Capital Improvement Program and Five-Year Plan. The Freeport project would also allow for a future groundwater conjunctive use component and, along with the proposed local groundwater projects, emergency interties and planned water recycling and conservation efforts, would ensure a reliable water supply to meet projected demands for current and future EBMUD customers within the current service area. Without a supplemental water supply source, continued conservation efforts and further use of recycled water, deficiencies in supply are projected as noted above.


The Oak to Ninth Avenue Mixed Use Development Project presents an opportunity to incorporate many water conservation measures. We appreciate that the City of Oakland has a Article Section, Article 10 of Chapter 7, covering landscape water conservation. Conditions of approval for the implementation of the Oak to Ninth Avenue Mixed Use Development Project should require that the project comply with the Landscape Water Conservation Section of the Municipal Code of the City of Oakland, Article 10 of Chapter 7. EBMUD staff would like the opportunity to meet with staff to discuss water conservation programs and best management practices applicable to the project area. A key objective of this discussion will be to explore timely opportunities to expand conservation via early consideration of EBMUD's conservation programs and best management practices applicable to the project.

Margaret Stanzione
August 12, 2004
Page 5

The Oak to Ninth Avenue Mixed Use Development Project area is located within the service area boundary of the District's East Bayshore Recycled Water Project. The District anticipates recycled water delivery to the project area by the year 2005 and recommends that the developer of this project discuss with the District the installation of dual plumbing for use of recycled water where feasible.

The project sponsor should contact David J. Rehnstrom, Senior Civil Engineer, at (510) 287-1365 for further information.

Sincerely,



WILLIAM R. KIRKPATRICK
Manager of Water Distribution Planning Division

sb04_265.doc.doc

- Enclosures: 1 Letter of Request for Water Supply Assessment dated June 3, 2004
2 EBMUD's 2000 Urban Water Management Plan Area
3 EBMUD's Projected Demand and Available Supply Table

cc: Board of Directors w/o Enclosure 2



CITY OF OAKLAND

Community and Economic Development Agency, Planning & Zoning Services Division
250 Frank H. Ogawa Plaza, Suite 3330, Oakland, California, 94612-2032

June 3, 2004

Mr. William Kirkpatrick
East Bay Municipal Utility District
Manager, Water Distribution Planning Division
P.O. Box 24055, MS 701
Oakland, CA 94607

RECEIVED
JUN 7 2004
WATER SERVICE PLANNING

RE: Request for Confirmation of Water Supply Assessment for the proposed Oak-to-Ninth
Mixed Use Project, Oakland

Dear Mr. Kirkpatrick:

Per amendments to Section 10912 of the Water Code implemented by Senate Bill 610, the City of Oakland is submitting this request to the East Bay Municipal Utility District (EBMUD) to prepare a water supply assessment. The assessment is required in order to determine whether adequate water supply is available to meet the projected water demand of the proposed Oak-to-Ninth Mixed Use Project. A Notice of Preparation for an Environment Impact Report (EIR) was sent to you on June 1, 2004 with a request for similar information.

The project is proposed on approximately 62 acres of waterfront property owned by the Port of Oakland. It includes up to 3,100 residential units, 200,000 square feet of ground-floor commercial space, 3,500 structured parking spaces, approximately 27 acres of public open space, two renovated marinas, and a wetlands restoration area. The project is proposed to be constructed in phases over approximately ten years.

The City respectfully requests that EBMUD immediately prepare a water supply assessment for the proposed project as on the description in the Notice of Preparation mailed to you earlier. The City acknowledges that this request for an assessment is a required part of the environmental document for the project. We appreciate your prompt response to this request.

Please contact me if you need additional information. I can be reached at (510) 238-4932 or by email at mstanzione@oaklandnet.com.

Sincerely,

Margaret Stanzione, Project Manager
Strategic Planning

cc: Patrick Van Ness, Oakland Harbor Partners
Katrina Koh, ESA

PROJECTED DEMAND AND AVAILABLE SUPPLY
EAST BAY MUNICIPAL UTILITY DISTRICT
(million gallons per day - mgd)

	2000	2005	2010	2015	2020
Customer Demand ¹	230	242	257	267	277
Adjusted for Conservation ²	(8)	(14)	(20)	(27)	(34)
Adjusted for Recycled Water ³	(6)	(9)	(11)	(12)	(14)
Planning Level of Demand	216	219	226	228	229
Available Supply & Need for Supplemental Supply					
Normal Year	>216	>219	>226	>228	>229
<i>Supplemental Supply Need</i>	0	0	0	0	0
Single Dry Year (Multiple Dry Years - Year 1) Moderate Stage (approximately 7% deficiency) ⁴	200	203	210	212	213
<i>Supplemental Supply Need</i>	0	0	0	0	0
Multiple Dry Years - Year 2 Severe Stage (approximately 25% deficiency) ⁴	162	164	169	171	172
<i>Supplemental Supply Need</i>	0	0	0	0	0
Multiple Dry Years - Year 3					
Available Supply	125	114	95	84	77
Deficiency	42%	48%	58%	63%	67%
<i>Supplemental Supply Need⁵ (to limit deficiency to 25%)</i>	87	102	128	142	154

1. Demand taken from the 2000 Demand Study.

2. Conservation water savings goals from the WCMP 1999 Annual Report, 2 mgd in 1999 and 34 mgd for year 2020, linearly interpolated into five-year increments.

3. Chapter 5 of UWMP.

Note: Conservation and Reclamation savings reported are those attributed to programs which are a part of the 1993 WSMP. Reference Chapter 6 of UWMP.

4. Drought conditions per Table 3-1, UWMP.

5. The supplemental supply need is calculated from modeling studies and is the amount of water needed to limit customer deficiency to 25 percent and to implement all provisions of the 1998 Joint Settlement Agreement.

Appendix G

Energy Calculations

Appendix G_Brooklyn Basin Project Fuel Use

8/10/2020

CO₂ emissions from Operational AQ Calculations (see Appendix D):

Conversion	1 MT =	1000 kg
------------	--------	---------

Gasoline Sources	
	CO ₂ Emissions
Operational Vehicles	2,474.00 MT
Convert to kilograms	2.47E+06 kg

Gasoline fuel combustion^a = 8.78 kg CO₂/gallon

Gasoline combustion rate = 281,776.77 gallons (per year during operation)

Notes: ^a Emissions factors per The Climate Registry 2019 Default Emission Factors (Table 2.1 - US Default CO₂ Emission Factors for Transport Fuels)

Source: SIMW Emissions Model (CY 2020 to 2050)

<https://ww3.arb.ca.gov/msprog/offroad/recmarine/ab1085compliance.htm>

SEASON	CY	COUNTY	CATEGORY	STRK-FUEL-TECH	STATUS	SumOf_Population-Operating-Baseline	SumOf_Population-Stored-Baseline	SumOf_Fuel_Consumption_Total-Baseline
ANNUAL	2026	Alameda	Auxiliary and Sail	Diesel	active	78.10295678	202.8970362	66.80550314
ANNUAL	2026	Alameda	Auxiliary and Sail	G2-CARB	active	9.545339354	24.79702619	2.244356439
ANNUAL	2026	Alameda	Auxiliary and Sail	G2-FI	active	0	0	0
ANNUAL	2026	Alameda	Auxiliary and Sail	G4-CARB	active	16.66242618	43.28590143	22.54310379
ANNUAL	2026	Alameda	Auxiliary and Sail	G4-FI	active	4.165606545	10.82147536	5.54671987
ANNUAL	2026	Alameda	Inboard	Diesel	active	372.5505706	967.8174777	148.4221189
ANNUAL	2026	Alameda	Inboard	G2-CARB	active	0	0	0
ANNUAL	2026	Alameda	Inboard	G2-FI	active	0	0	0
ANNUAL	2026	Alameda	Inboard	G4-CARB	active	92.91068497	241.3647753	50.45043519
ANNUAL	2026	Alameda	Inboard	G4-FI	active	698.7592776	1815.247365	521.4819978
ANNUAL	2026	Alameda	Jet	G2-CARB	active	85.9025754	223.1590028	19.22239699
ANNUAL	2026	Alameda	Jet	G2-FI	active	18.33710032	47.63639512	7.4720491
ANNUAL	2026	Alameda	Jet	G4-CARB	active	5.322145326	13.82594921	0.817684993
ANNUAL	2026	Alameda	Jet	G4-FI	active	146.8019787	381.3643889	51.0465605
ANNUAL	2026	Alameda	Outboard	G2-CARB	active	1117.48003	2903.006436	340.7924675
ANNUAL	2026	Alameda	Outboard	G2-FI	active	390.5571411	1014.595218	270.1283572
ANNUAL	2026	Alameda	Outboard	G4-CARB	active	653.8223762	1698.509606	81.05906299
ANNUAL	2026	Alameda	Outboard	G4-FI	active	840.7602366	2184.139593	502.8706181
ANNUAL	2026	Alameda	PWC	G2-CARB	active	391.8098043	1017.849405	187.2427761
ANNUAL	2026	Alameda	PWC	G2-FI	active	90.94725424	236.2641454	50.42207107
ANNUAL	2026	Alameda	PWC	G4-CARB	active	0.100234408	0.260390452	0.007108449
ANNUAL	2026	Alameda	PWC	G4-FI	active	1241.305101	3224.681067	872.0823559
ANNUAL	2026	Alameda	Sterndrive	G2-CARB	active	3.079491697	7.999949864	0.099138749
ANNUAL	2026	Alameda	Sterndrive	G2-FI	active	0	0	0
ANNUAL	2026	Alameda	Sterndrive	G4-CARB	active	1191.655577	3095.700788	377.1070584
ANNUAL	2026	Alameda	Sterndrive	G4-FI	active	1101.976996	2862.732419	555.0259903

TOTAL **8552.554904** **22217.95581** **4132.889932**

	gallons/day	# of Vessels	Vessel %
total diesel	215.227622	1621.368041	95%
total gas	3917.66231	29149.14267	5%
TOTAL	4132.889932	30770.51071	100%

	# of vessels	gallons/day	gallons/yr
Project Vessels	166		
Gas	158	21.2	7738
Diesel	8	1.1	402

Water Taxi Fuel Demand from GHG Calculations:

Diesel Sources	
Water Taxi CO2 Emissions (from Appendix D Table C-6)	CO2 Emissions 579.4 MT/yr
TOTAL Diesel Sources =	579.4 MT/yr
Convert to kilograms	5.79E+05 kg

Per CCAR GRP (2009):

Diesel fuel combustion =

10.15 kg CO2/gallon

Diesel Combustion =

57083.74 gallons/year

